

# SCORPION

## MODULAR POWER, SIGNAL CONNECTORS

---

- The most versatile power/signal connector on the planet
- Rated up to 100 amperes per contact plus ability to add signal contacts and a variety of accessories
- Blank modules for greater creepage and clearance to suit higher voltage needs
- Unique locking/guide systems for blind mating, float mount, and cable connector options

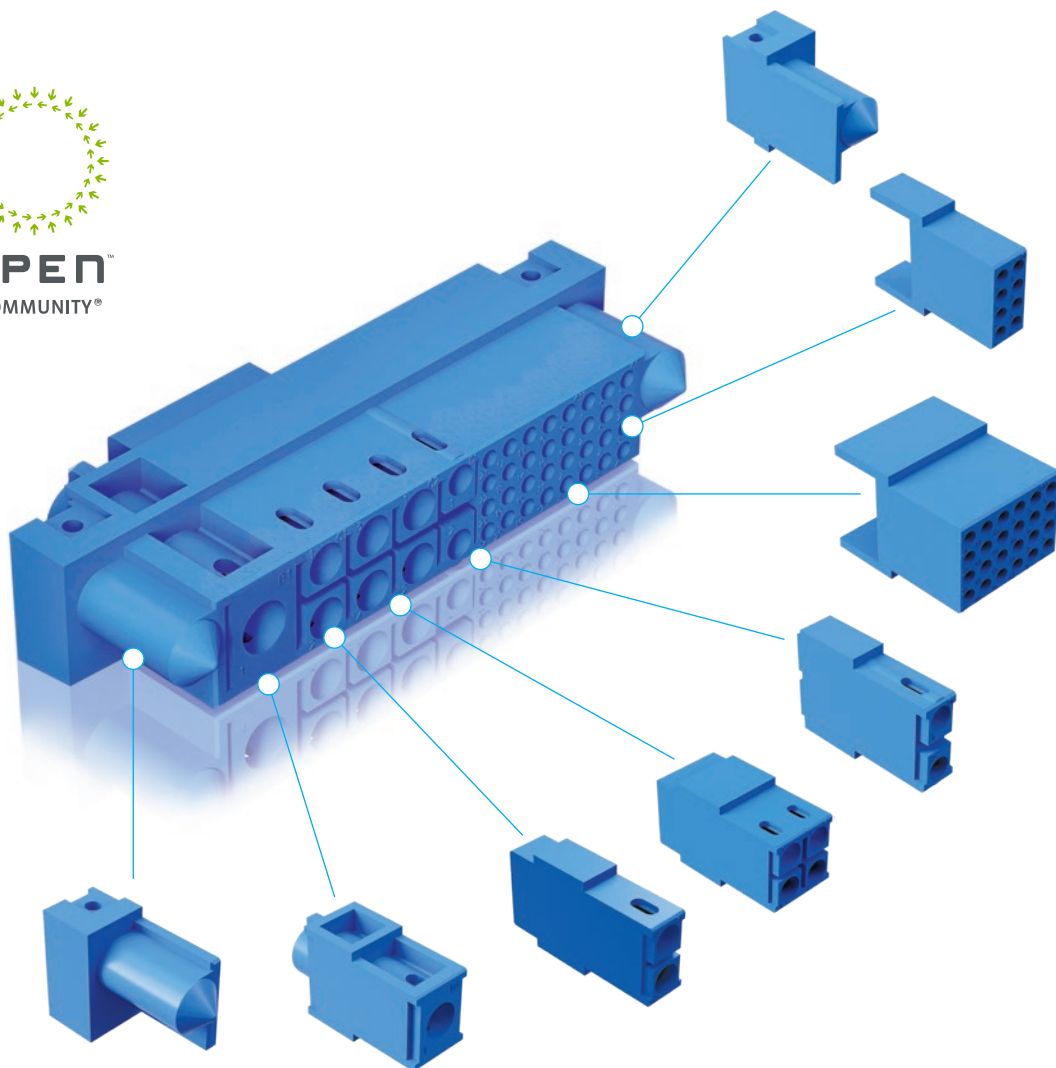

**Positronic**<sup>®</sup>  
an Amphenol company

THE SCIENCE OF **CERTAINTY**<sup>®</sup>

M015 Rev B1 22/06

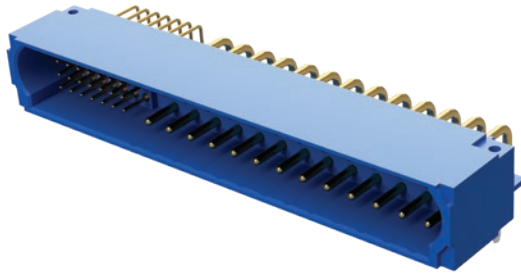

**Scorpion** brings a unique approach to modular connector design that is only available from Positronic. **Scorpion** provides the flexibility to configure the connector to meet your specifications. The difference is how Positronic builds the final connector, using our innovative tooling and injection molding process. The result is a one-piece insulator with machined contacts, ready to perform.

Trust the **Scorpion** to deliver ***The Science of Certainty.***

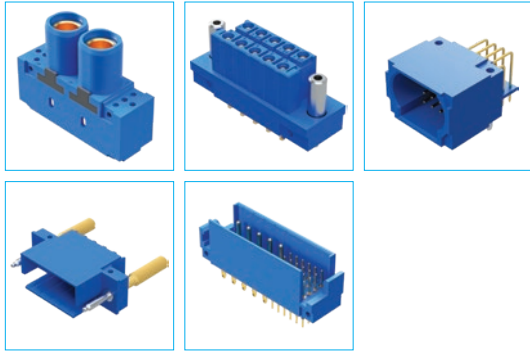

## NOTES ABOUT SCORPION CONNECTORS

- A Scorpion part number can have a maximum of 30 characters. If your connector configuration exceeds this number, a special part number will be created for you.
- Pinout sequence may not be continuous. Contact Technical Sales for more information.
- Contact Technical Sales to configure a connector whose length exceeds 101.00 [3.976].
- For connectors offering both fixed and removable contacts, contact Technical Sales.
- Alignment bar is available for size 16, size 18, size 22, and hyperboloid Ø0.60 [.0236] right angle contacts.
- PosiBand contacts available for size 12, 16, 18, and 22.
- If there are more than 36 signal pins in a single Scorpion connector, customer will need to take note of the tolerances and potential alignment issues.

### TABLE OF CONTENTS

Scorpion Overview	2	Mating Dimensions	11
OCP ORV3 Universal AC Input Connectors	3	Temperature Rise Curves	11 - 12
Tech Specs	4 - 5	Accessories	13 - 18
Create a Part	6 - 7	Contacts	19 - 21
Body Style	8	Tooling	22
Module Layouts	9 - 10	Overall Length (OAL)	23
Contact Terminations Dimensions	10		



**Female crimp connector with backshell**

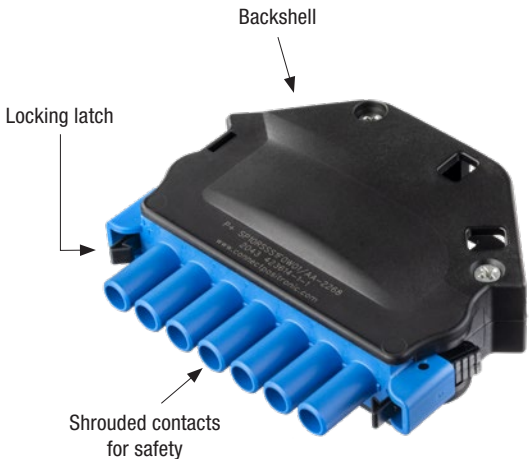

Positronic designed the OCP ORV3 universal AC input connector based on what we have learned about power management through nearly three decades of developing power connectors for specific applications. Positronic brings these years of power connector experience to your overall OCP needs—in the power shelf, the server, or any other aspect of power management.

**Typical Connector Part Numbers**

Part Numbers	Description	Gender	Termination
SP10RSSS48M220A1/AA-2269	Connector	Male	Right angle PCB
SP10RSSS48RM220A1/AA-2269	Connector	Male	Right angle PCB, inverted
SP10RSSS1M2001/AA-2268	Connector	Male	Crimp
SP10RSSS1F0W01/AA-2268	Connector, backshell	Female	Crimp
SP10RSSS1F0001/AA-2268	Connector	Female	Crimp
FC4008DS/AA-2272	Contact, crimp	Female	AWG 8
FC4010DS/AA-2272	Contact, crimp	Female	AWG 10
FC4012DS/AA-2272	Contact, crimp	Female	AWG 12
MC4008DS/AA-2271	Contact, crimp	Male	AWG 8
MC4010DS/AA-2271	Contact, crimp	Male	AWG 10
MC4012DS/AA-2271	Contact, crimp	Male	AWG 12
MC4008DS/AA-2270	Contact, crimp, first mate	Male	AWG 8
MC4010DS/AA-2270	Contact, crimp, first mate	Male	AWG 10
MC4012DS/AA-2270	Contact, crimp, first mate	Male	AWG 12

**Male PCB connector**

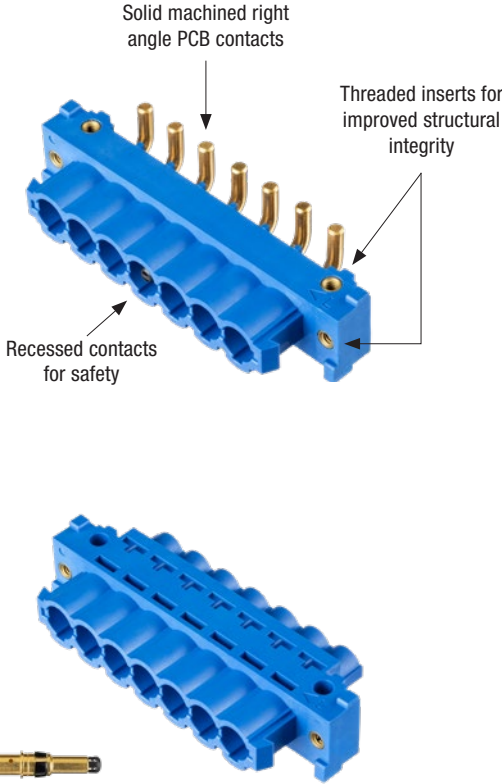

Male connector also available for use with crimp contacts

## TECH SPECS

### GENERAL

Part Number Prefix	SP
Performance Level	Industrial Mil/aero
Qualifications	UL #E49351*1
RoHS Compliance	RoHS 5/6 (6/6 on select parts)

\*1 Partial UL certification only. Contact Technical Sales for specific connector qualifications.

### MATERIAL

Insulator	Polyester
Insulator Color	Blue
Flammability Rating	UL 94V-0
Contact Material	Copper alloy
Contact Plating	Gold flash 0.76µm Au (min) 1.27µm Au (min)

### ELECTRICAL

**Working Voltage (rms)** 100V to 1000V (Contact Technical Sales for details)

**Insulation Resistance** 5 G ohms  
 Per IEC 512-2, Test 3a, Method A

Initial Contact Resistance (max)	Contact Size	Standard Conductivity	High Conductivity
	Size 4	0.3 mΩ	0.2 mΩ
	Size 8	0.6 mΩ	0.4 mΩ
	Size 12	1.0 mΩ	0.5 mΩ
	Size 16	1.6 mΩ	0.5 mΩ
	Size 18	3.0 mΩ	0.7 mΩ
	Size 22	5.0 mΩ	
	Hyperboloid Contacts	5.0 mΩ	

Contact Current Rating	Contact Size	Standard Conductivity	High Conductivity
	Size 4	100A	120A
	Size 8	50A	80A
	Size 12	40A	60A
	Size 16	26A	40A
	Size 18	16A	23A
	Size 22	3A	
	Hyperboloid Contacts	4A	

Dielectric Withstanding Voltage	Contact Size	Standard Conductivity
Per IEC 512-2, Test 4a, Method C	Size 4	3000V typical
	Size 8, 12, 16, 18	2200V typical
	Size 22	1600V typical
	Hyperboloid Contacts	1200V typical

## TECH SPECS

### ELECTRICAL

**Clearance and Creepage Distances** *Contact Technical Sales for information about your specific connector choice*

**Hot Pluggable**  
[50 Couplings per UL1977, paragraph 15]      Size 12      250 VAC @ 25A. *Contact Technical Sales for details.*

### MECHANICAL

**Female Contact Design**      PosiBand closed entry  
Open entry

**Mechanical Durability**  
Per IEC 512-5      Size 4, 8, 12, 16, 18      1000 cycles minimum  
Size 22      500 cycles minimum  
  
Hyperboloid Contacts      Contact Technical Sales

**Removable Contact Retention in Connector Body**  
Per IEC 512-8, Test 15a      Size 4      134N [30 lbs] minimum  
Size 8, 12, 16      67N [15 lbs] minimum  
Size 18      36N [8 lbs] minimum  
Size 22      27N [6 lbs] minimum

**Fixed Contact Retention in Connector Body**  
Per IEC 512-8, Test 15a      Size 4      67N [15 lbs] minimum  
Size 8, 12, 16      45N [10 lbs] minimum  
Size 18      45N [10 lbs] minimum  
Size 22      27N [6 lbs] minimum  
  
Hyperboloid Contacts      27N [6 lbs] minimum

**Sequential Contact Mating System**      Size 4      One level  
Size 8      Two levels  
Size 12      Two levels - Consult Technical Sales for three levels  
Size 16      Two levels - Consult Technical Sales for three levels  
Size 18      Two levels - Consult Technical Sales for three levels  
Size 22      One level  
Two levels for printed board mount connectors  
  
Hyperboloid Contacts      One level

**Polarization**      Design of connector body provides polarization features

### ENVIRONMENTAL

**Operating Temperature**      -55 to 125°C

## CREATE A PART

To build mating connector part numbers, choose the same modules in the same order in the **Layout** step. Female connector modules are placed right to left when viewed from the mating face. Male connector modules are the reverse.

SP

1

UU

1

M

Series

- SP Scorpion

Body Style [For more information, refer to page 8](#)

**Blind Mating**

- 1 Blind mating, 3.80 [.150] misalignment
- 2 Blind mating, 2.00 [.079] misalignment
- 7 Blind mating, 2.00 [.079] misalignment (use for code O, BS, or N in Mounting Options step)
- 8 Blind mating, up to 3.90 [.154] misalignment, up to 5° angular misalignment

**Latching System**

- 3 Locking latch, use with female free cable to male cable
- 4 Locking latch, use with male free cable to female panel mount (wire or PCB)
- 5 Locking latch, use with female free cable to male panel mount (wire or PCB)

**Jackscrews**

- 6 For use with jackscrew system

Layout [For dimensional information, refer to pages 9-10](#)

**Select as many modules in this step as required as long as the OAL does not exceed 101mm.**

**Contact Modules**

<ul style="list-style-type: none"> <li>U (1) #4 contact</li> <li>R (1) #8 contact</li> <li>S (2) #8 contacts</li> <li>E (2) #12 contacts</li> <li>Y (4) #12 contacts</li> <li>A (1) #16 contacts</li> <li>B (2) #16 contacts</li> <li>C (4) #16 contacts</li> <li>D (8) #16 contacts</li> <li>X (3) #18 contacts</li> <li>Z (6) #18 contacts</li> <li>H (4) #22 contacts</li> <li>J (8) #22 contacts</li> <li>K (12) #22 contacts</li> <li>T (24) #22 contacts</li> </ul>	<ul style="list-style-type: none"> <li>V (10) Hyperboloid Ø0.60 [.0236]<sup>*1</sup></li> <li>W (20) Hyperboloid Ø0.60 [.0236]<sup>*1</sup></li> <li>O Keying module</li> <li>N Spacer/blank, extra small</li> <li>N2 Spacer/blank, small</li> <li>N3 Spacer/blank, medium</li> <li>N4 Spacer/blank, large</li> <li>N5 Spacer/blank, extra large<sup>*2</sup></li> </ul>
---	--

<sup>\*1</sup> Unique high density contact design with machined pin diameter Ø0.60 [.0236], for straight and right angle (90°) PCB mount only. Contact Technical Sales for availability of crimp terminal.

<sup>\*2</sup> For a backshell application, use code N5 in the first and last Layout position.

Termination [For more information, refer to page 10](#)

- 1 Wire, order contacts separately<sup>\*1</sup>
- 3 Straight solder
- 38 Straight solder, high conductivity power contacts
- 93 Straight press-fit, for use with PCB not thinner than 2.29 [.090]<sup>\*2</sup>
- 938 Straight press-fit, for use with PCB not thinner than 2.29 [.090], high conductivity power contacts<sup>\*2</sup>
- 4 Right angle solder
- 48 Right angle solder, high conductivity power contacts

<sup>\*1</sup> To order contacts separately, see pages 19-21 for contact part numbers. Select 'S' in Contact Gender step.

<sup>\*2</sup> For contacts size 8, 12, 16, 18 and 22 only. Contact Technical Sales for press-fit tooling part numbers.

Contact Gender

- M Male pin
- F Female socket, open entry signal contacts
- S Female socket, PosiBand closed entry signal contacts

CREATE A PART

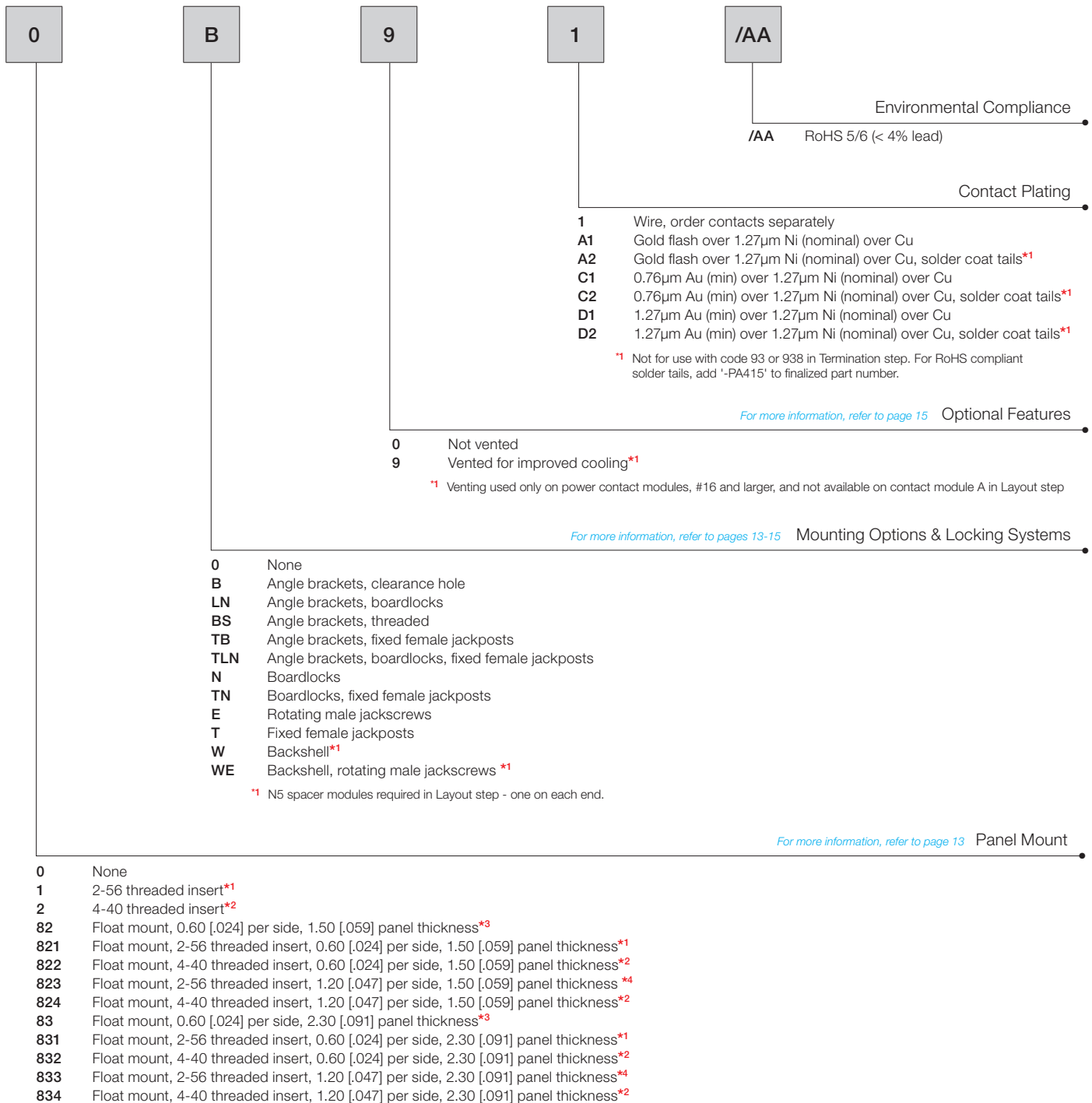

\*<sup>1</sup> For use with code 1 or 2 in Body Style step.

\*<sup>2</sup> For use with code 8 in Body Style step.

\*<sup>3</sup> For use with code 1, 2, 4, or 5 in Body Style step.

\*<sup>4</sup> For use with code 1 in Body Style step.

**BODY STYLE**

All module heights measure 14.60 [.575].

For the sake of brevity, only the left side of the end module face view is shown.

MALE	FEMALE	CODE	GENDER	A <sup>*1</sup>	FEATURE
		1	Male	8.26 [.325]	Blind mating, 3.80 [.150] misalignment
			Female	8.26 [.325]	
		2	Male	5.00 [.197]	Blind mating, 2.00 [.079] misalignment
			Female	5.00 [.197]	
		7	Male	4.50 [.177]	Blind mating, 2.00 [.079] misalignment (use for code 0, BS, or N in Mounting Options step)
			Female	4.50 [.177]	
		8	Male	9.50 [.374]	Blind mating, up to 3.90 [.154] misalignment, up to 5° angular misalignment
			Female	9.50 [.374]	
		3	Male	4.00 [.157]	Latching system
			Female	2.80 [.110]	
		4	Male	4.76 [.157]	Latching system
			Female	5.00 [.197]	
		5	Male	5.00 [.197]	Latching system
			Female	2.80 [.110]	
		6	Male	9.20 [.362]	Jackscrew
			Female	9.20 [.362]	

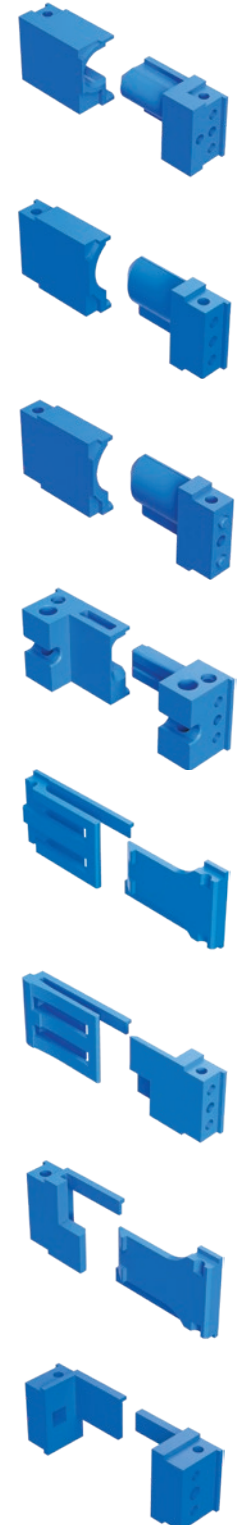

\*1 Dimension shown is for one end module, but connector will be provided with two end modules, one left and one right.



## MODULE LAYOUTS\*1

All module heights measure 14.60 [.575].

For the sake of brevity, only male module face view is shown.

CONTACT MODULES	CODE	SIZE	A	B	C
	U	#4	14.20 [.559]	-	-
	R	#8	9.40 [.370]	-	-
	S	#8	18.80 [.740]	9.40 [.370]	-
	E	#12	5.90 [.232]	-	6.00 [.236]
	Y	#12	11.80 [.465]	5.90 [.232]	6.00 [.236]
	A	#16	4.96 [.195]	-	-
	B	#16	4.96 [.195]	-	7.20 [.283]
	C	#16	9.92 [.391]	4.96 [.195]	7.20 [.283]
	D	#16	19.84 [.781]	3x 4.96 [.195]	7.20 [.283]

CONTACT MODULES	CODE	SIZE	A	B	C
	X	#18	3.80 [.150]	-	2x 3.80 [.150]
	Z	#18	7.60 [.299]	3.80 [.150]	2x 3.80 [.150]
	H	#22	2.70 [.106]	-	3x 2.70 [.106]
	J	#22	5.40 [.213]	2.70 [.106]	3x 2.70 [.106]
	K	#22	8.10 [.319]	2.70 [.106]	3x 2.70 [.106]
	T	#22	16.20 [.638]	5x 2.70 [.106]	3x 2.70 [.106]

Contact Size Chart						
#4	#8	#12	#16	#18	#22	0.60mm

All Positronic products utilize solid, machined contacts.



## MODULE LAYOUTS

All module heights measure 14.60 [.575].

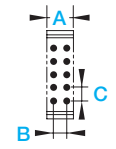
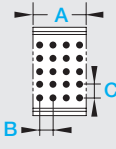
For the sake of brevity, only male module face view is shown.

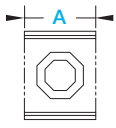
HYPERBOLOID MODULES 0.60 [.0236]	CODE	A	B	C
	V	4.40 [.173]	2.20 [.087]	3x 2.20 [.087]
	W	8.80 [.346]	4x 2.20 [.087]	4x 2.20 [.087]

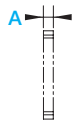
KEYING MODULE	CODE	A
	O	11.80 [.465]

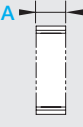
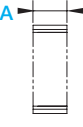
BLANK MODULES	CODE	A
	N	1.62 [.064]
	N2	2.00 [.079]
	N3	3.46 [.136]
	N4	4.88 [.192]
	N5	5.60 [.220]

## CONTACT TERMINATION DIMENSIONS

For the sake of brevity, only the male size 8 & 12 contact modules are shown. Dimensions shown apply to all contacts regardless of size and gender.

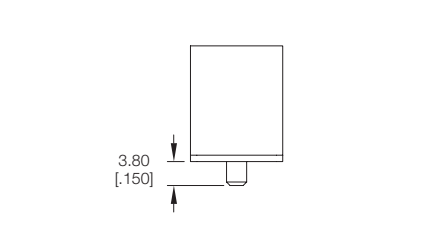
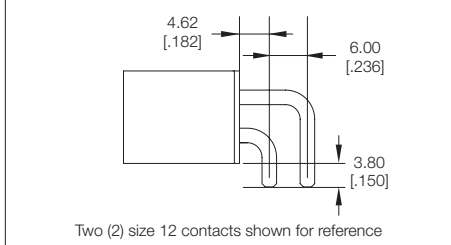
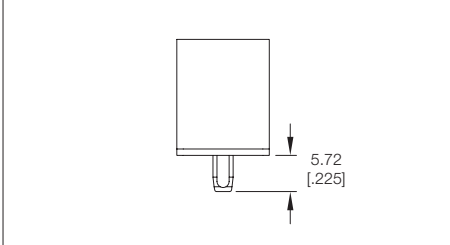
STRAIGHT SOLDER	RIGHT ANGLE SOLDER	PRESS-FIT <sup>*1</sup>
		

\*1 For information about suggested PCB hole sizes, please visit our website to [download SK6370](#).

## MATING DIMENSIONS

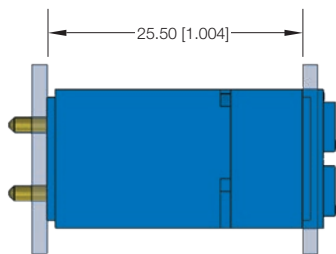

Straight PCB Mount (Male) to Panel Mount Crimp (Female)

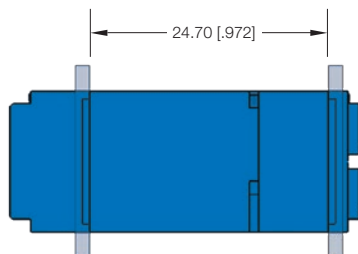

Panel Mount Crimp (Male) to Panel Mount Crimp (Female)

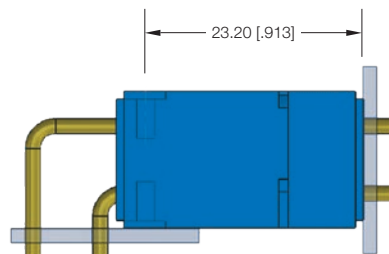

Right Angle Board Mount (Male) to Straight PCB Mount (Female)

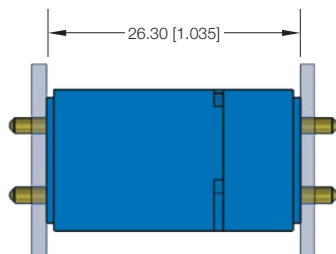

Straight PCB Mount (Male) to Straight PCB Mount (Female)

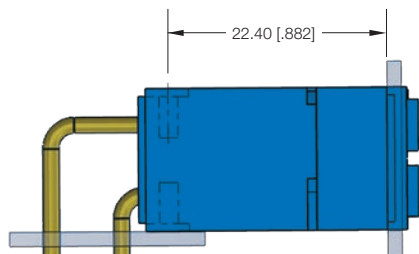

Right Angle Board Mount (Male) to Panel Mount Crimp (Female)

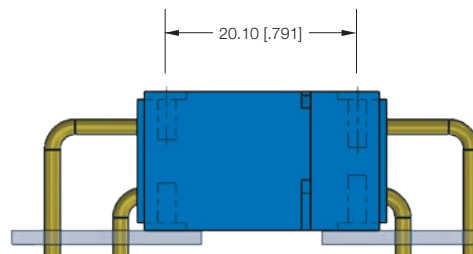

Right Angle Board Mount (Male) to Right Angle Board Mount (Female)

## TEMPERATURE RISE CURVES

Tested per IEC Publication 60512-3, Test 5a

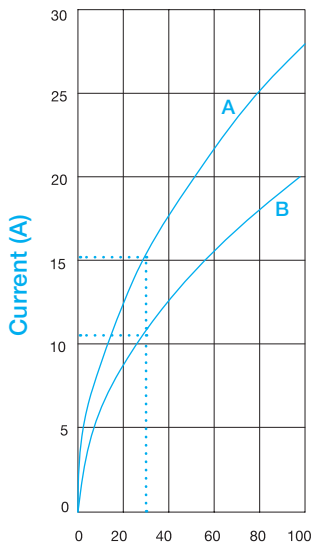

### Size 18 Temperature rise (°C)

- A** Developed with (6) #18 high conductivity contacts seated in code Z modules.
- B** Developed with (6) #18 standard conductivity contacts seated in code Z modules.

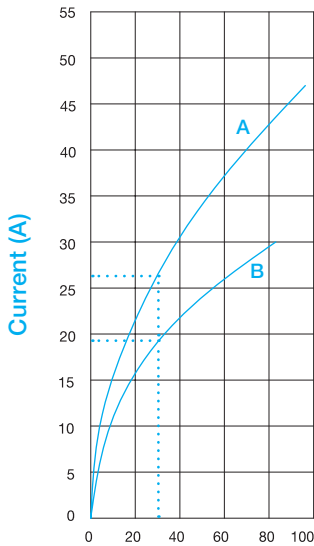

### Size 16 Temperature rise (°C)

- A** Developed with (2) #16 high conductivity contacts seated in code B modules.
- B** Developed with (2) #16 standard conductivity contacts seated in code B modules.

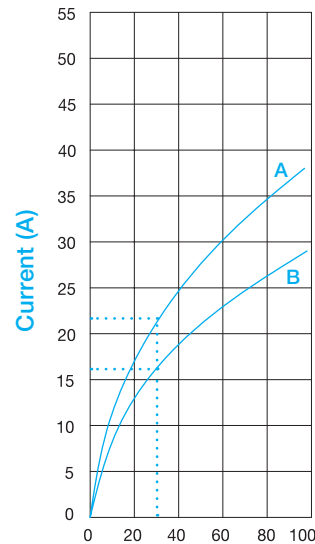

### Size 16 Temperature rise (°C)

- A** Developed with (8) #16 high conductivity contacts seated in code CC modules.
- B** Developed with (8) #16 standard conductivity contacts seated in code CC modules.

# TEMPERATURE RISE CURVES

Tested per IEC Publication 60512-3, Test 5a

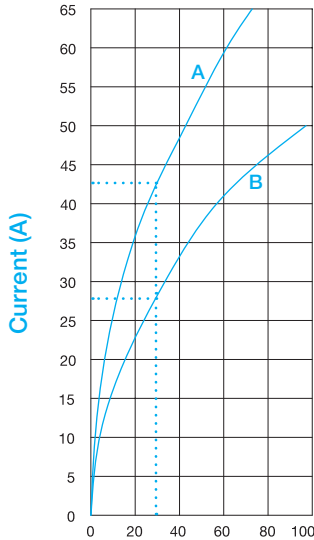

**Size 12 Temperature rise (°C)**

- A** Developed with (2) #12 high conductivity contacts seated in code E modules.
- B** Developed with (2) #12 standard conductivity contacts seated in code E modules.

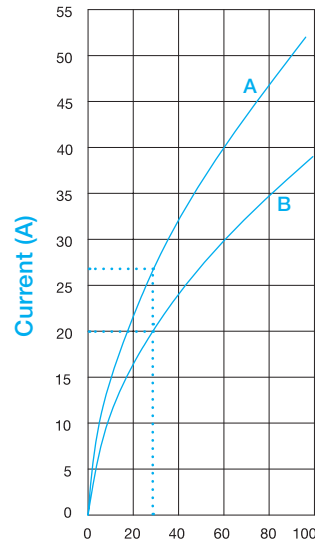

**Size 12 Temperature rise (°C)**

- A** Developed with (10) #12 high conductivity contacts seated in code EYY modules.
- B** Developed with (10) #12 standard conductivity contacts seated in code EYY modules.

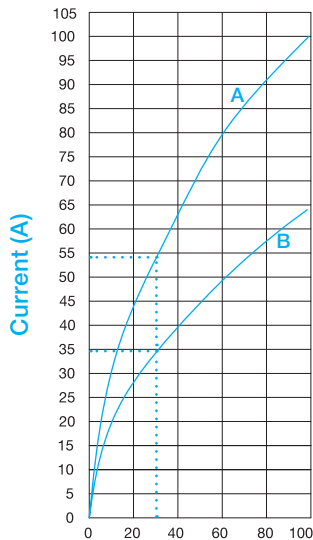

**Size 8 Temperature rise (°C)**

- A** Developed with (2) #8 high conductivity contacts seated in code RR modules.
- B** Developed with (2) #8 standard conductivity contacts seated in code RR modules.

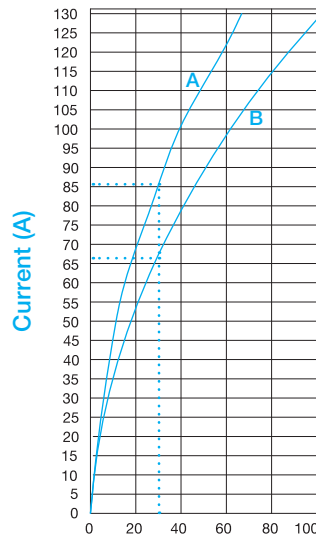

**Size 4 Temperature rise (°C)**

- A** Developed with (2) #4 high conductivity contacts seated in code UU modules.
- B** Developed with (2) #4 standard conductivity contacts seated in code UU modules.

# ACCESSORIES

## PANEL MOUNT

**1**

2-56 threaded insert<sup>\*1</sup>



**821**

Float mount, 2-56 threaded insert, 0.60 [.024] per side, 1.50 [.059] panel thickness<sup>\*1</sup>

**823**

Float mount, 2-56 threaded insert, 1.20 [.047] per side, 1.50 [.059] panel thickness<sup>\*4</sup>



**831**

Float mount, 2-56 threaded insert, 0.60 [.024] per side, 2.30 [.091] panel thickness<sup>\*1</sup>

**833**

Float mount, 2-56 threaded insert, 1.20 [.047] per side, 2.30 [.091] panel thickness<sup>\*4</sup>

**2**

4-40 threaded insert<sup>\*2</sup>



**822**

Float mount, 4-40 threaded insert, 0.60 [0.024] per side, 1.50 [0.059] panel thickness<sup>\*2</sup>

**824**

Float mount, 4-40 threaded insert, 1.20 [.047] per side, 1.50 [.059] panel thickness<sup>\*2</sup>

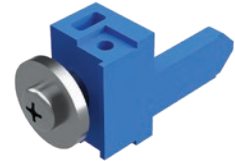

**832**

Float mount, 4-40 threaded insert, 0.60 [.024] per side, 2.30 [.091] panel thickness<sup>\*2</sup>

**834**

Float mount, 4-40 threaded insert, 1.20 [.047] per side, 2.30 [.091] panel thickness<sup>\*2</sup>

**82**

Float mount, 0.60 [.024] per side, 1.50 [.059] panel thickness<sup>\*3</sup>



**83**

Float mount, 0.60 [.024] per side, 2.30 [.091] panel thickness<sup>\*3</sup>

<sup>\*1</sup> For use with code 1 or 2 in Body Style step.

<sup>\*2</sup> For use with code 8 in Body Style step.

<sup>\*3</sup> For use with code 1, 2, 4 or 5 in Body Style step, contact Technical Sales for more floating options.

<sup>\*4</sup> For use with code 1 in Body Style step, contact Technical Sales for more floating options.

CODE	MATERIALS
1, 2	Brass
82, 83, 821, 822, 823, 824, 831, 832, 833, 834	Steel with zinc plate

## PCB MOUNT

**B**

Angle brackets, clearance hole



**BS**

Angle brackets, threaded



**LN**

Angle brackets, boardlocks



**N**

Boardlocks  
(For straight mount)

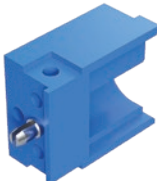

**N**

Boardlocks  
(For right angle mount)



CODE	MATERIALS
B, BS, LN	Brass with tin plate
N	Copper alloy with tin plate

**ACCESSORIES**

**JACKPOST/JACKSCREW SYSTEMS**

**E**  
 Rotating male jackscrews



**T**  
 Fixed female jackposts



**TB**  
 Angle brackets, fixed female jackposts



**TN**  
 Boardlocks, fixed female jackposts  
 (For straight mount)



**TN**  
 Boardlocks, fixed female jackposts  
 (For right angle mount)



**TLN**  
 Angle brackets, boardlocks, fixed female jackposts



**MATERIALS**

<b>Screw</b>	Steel with zinc plate
<b>Jackscrew, jackpost, hex nut, and lockwasher</b>	Stainless steel, passivated
<b>Knobs</b>	Aluminum, yellow anodized

## ACCESSORIES

### BACKSHELL

**W**

Backshell\*1

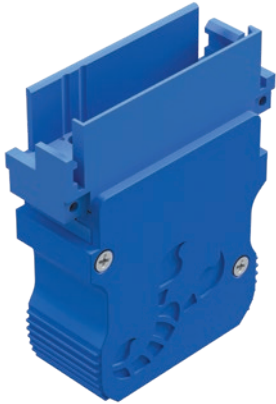

**WE**

Backshell, rotating male jackscrews\*1

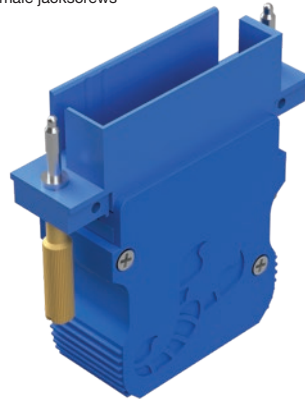

\*1 For use with two N5 spacer modules in Layout step, one spacer will be needed on each end of connector.

### MATERIALS

<b>Backshell</b>	Glass-filled polyester, UL94 V-0, blue
<b>Screws</b>	Steel, zinc plate with chromate seal
<b>Cable clamp</b>	Steel with nickel plate
<b>Cable clamp screws</b>	Brass, zinc plate with chromate seal

### VENTING FEATURES

The venting feature is an outlet hole enabling air cooling to better penetrate the area around the power contacts. This feature complies with with UL 1977, Section 10.2 Accessibility of Live Parts.

**0**

Not vented



**9**

Vented for improved cooling



## ADDITIONAL INFORMATION

### LOCKING CLIP (used on size 4 contacts only)

#### INSERTION

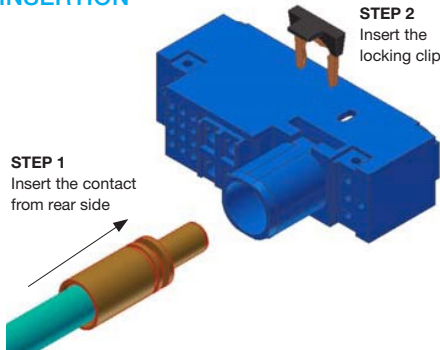

#### EXTRACTION

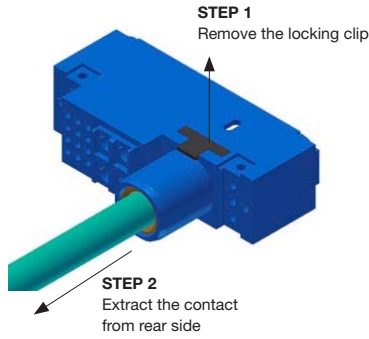

#### LOCKING CLIP

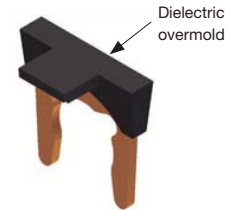

#### MATERIALS

<b>Locking clip</b>	Copper alloy with nylon, UL 94V-0 dielectric overmold, black color
<b>Finish</b>	Gold flash over nickel plate

### KEYING MODULE AND PLUG

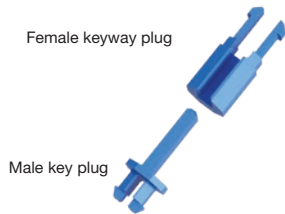

#### MATERIALS

Glass-filled polyester, UL 94V-0, Color: Blue.

#### Male Insertion / Extraction Tool

9505-1-1-0

#### Female Insertion / Extraction Tool

9505-1-2-0

#### Notes

- 1 Default factory setting for keying plug on keying module is at position 1.
- 2 There are eight (8) available positions for customers to choose from. Customers can change the position by using the dedicated key plug tooling.

#### FEMALE KEYWAY PLUG - INSERTION

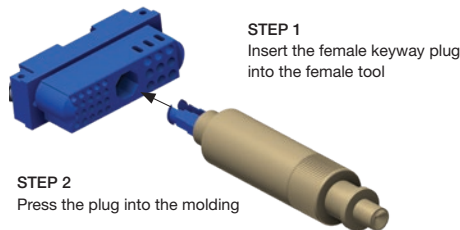

#### EXTRACTION

Unlock the female plug from the rear side.

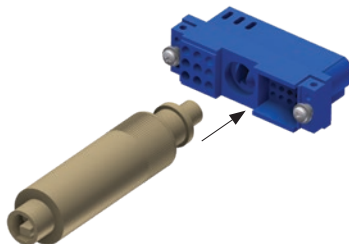

#### MALE KEY PLUG - INSERTION

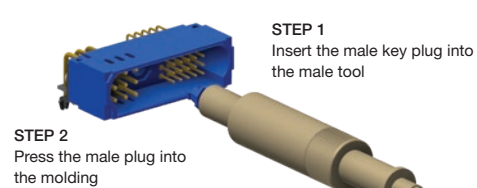

#### EXTRACTION

Unlock the male plug from the rear side

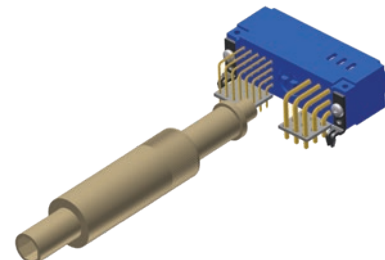



## MOUNTING SCREWS

### SELF TAPPING SCREW

PART NUMBER	MATERIAL	THREAD LENGTH	RECOMMENDED PC BOARD THICKNESS (when applicable)
A4546-7-1-97	Steel	6.35±0.76 [.250±.030]	2.36 [.093]
A4546-7-2-97	Steel	7.93±0.76 [.312±.030]	3.18 [.125]
A4546-7-3-97	Steel	9.53±0.76 [.375±.030]	4.45 [.175]
A4546-7-6-4	Stainless Steel	6.35±0.76 [.250±.030]	2.36 [.093]
A4546-7-7-4	Stainless Steel	7.93±0.76 [.312±.030]	3.18 [.125]
A4546-7-8-4	Stainless Steel	9.53±0.76 [.375±.030]	4.45 [.175]

Recommended mating torque 0.124 – 0.146 N. m (1.1 – 1.3 in-lb)

### SCREW, 2-56 UNC-2A (use with threaded insert)

PART NUMBER	MATERIAL	THREAD LENGTH	RECOMMENDED PC BOARD THICKNESS (when applicable)
A2074-12-1-97	Steel	6.81±0.76 [.268±.030]	2.36 [.093]
A2074-12-2-97	Steel	7.63±0.76 [.300±.030]	3.18 [.125]
A2074-12-3-97	Steel	8.90±0.76 [.350±.030]	4.45 [.175]
A2074-12-4-4	Stainless Steel	6.81±0.76 [.268±.030]	2.36 [.093]
A2074-12-5-4	Stainless Steel	7.63±0.76 [.300±.030]	3.18 [.125]
A2074-12-6-4	Stainless Steel	8.90±0.76 [.350±.030]	4.45 [.175]

Recommended mating torque 0.158 – 0.169 N. m (1.4 – 1.5 in-lb)

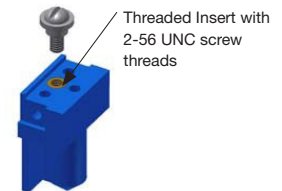

#### Notes

- 1 Threaded insert pre-installed at factory
- 2 Material: Brass
- 3 Consult Technical Sales for part numbering

## MOUNTING SCREWS

### SCREW, 4-40 UNC-2A (use with SP8 right angle PCB or panel connector)

PART NUMBER	MATERIAL	THREAD LENGTH	RECOMMENDED PC BOARD THICKNESS (when applicable)
A2076-42-7-97	Steel	21.00±0.76 [.826±.030]	2.36 [.093]
A2076-42-7-97	Steel	21.00±0.76 [.826±.030]	3.18 [.125]
A2076-42-8-97	Steel	23.00±0.76 [.905±.030]	4.45 [.175]
A2076-42-6-97	Steel	19.50±0.76 [.767±.030]	Panel 1.50 [.059] and 2.30 [.091]
A2076-42-16-4	Stainless Steel	21.00±0.76 [.826±.030]	2.36 [.093]
A2076-42-16-4	Stainless Steel	21.00±0.76 [.826±.030]	3.18 [.125]
A2076-42-17-4	Stainless Steel	23.00±0.76 [.905±.030]	4.45 [.175]
A2076-42-15-4	Stainless Steel	19.50±0.76 [.767±.030]	Panel 1.50 [.059] and 2.30 [.091]

Recommended mating torque 0.27 – 0.305 N. m (2.4 – 2.7 in-lb)

### SCREW, 4-40 UNC-2A (use with SP8 straight PCB or panel connector)

PART NUMBER	MATERIAL	THREAD LENGTH	RECOMMENDED PC BOARD THICKNESS (when applicable)
A2076-42-4-97	Steel	13.50±0.76 [.531±.030]	2.36 [.093]
A2076-42-4-97	Steel	13.50±0.76 [.531±.030]	3.18 [.125]
A2076-42-5-97	Steel	15.00±0.76 [.590±.030]	4.45 [.175]
A2076-42-3-97	Steel	12.00±0.76 [.472±.030]	Panel 1.50 [.059] and 2.30 [.091]
A2076-42-13-4	Stainless Steel	13.50±0.76 [.531±.030]	2.36 [.093]
A2076-42-13-4	Stainless Steel	13.50±0.76 [.531±.030]	3.18 [.125]
A2076-42-14-4	Stainless Steel	15.00±0.76 [.590±.030]	4.45 [.175]
A2076-42-12-4	Stainless Steel	12.00±0.76 [.472±.030]	Panel 1.50 [.059] and 2.30 [.091]

Recommended mating torque 0.27 – 0.305 N. m (2.4 – 2.7 in-lb)

### SCREW, 4-40 UNC-2A (use with SP8 with Threaded Insert)

PART NUMBER	MATERIAL	THREAD LENGTH	RECOMMENDED PC BOARD THICKNESS (when applicable)
A2076-42-0-97	Steel	7.50±0.76 [.295±.030]	2.36 [.093]
A2076-42-1-97	Steel	8.50±0.76 [.334±.030]	3.18 [.125]
A2076-42-2-97	Steel	9.50±0.76 [.374±.030]	4.45 [.175]
A2076-42-9-4	Stainless Steel	7.50±0.76 [.295±.030]	2.36 [.093]
A2076-42-10-4	Stainless Steel	8.50±0.76 [.334±.030]	3.18 [.125]
A2076-42-11-4	Stainless Steel	9.50±0.76 [.374±.030]	4.45 [.175]

Recommended mating torque 0.27 – 0.305 N. m (2.4 – 2.7 in-lb)

# CONTACTS

Contact Technical Sales for more details on additional contact sizes, material, finishes, and termination styles.

SC	Standard conductivity contacts
HC	High conductivity contacts

## REMOVABLE CRIMP CONTACTS

PART NUMBER	SC / HC	Size	Gender	Female Contact Style	Stranded AWG [mm <sup>2</sup> ]	Sequential Mate
FC0404N2/AA	SC	#4	Female	Closed entry	#4 [25.0]	
FC0404N2S/AA	HC	#4	Female	Closed entry	#4 [25.0]	
MC0404N/AA	SC	#4	Male	n/a	#4 [25.0]	
MC0404NS/AA	HC	#4	Male	n/a	#4 [25.0]	
FC4008DS/AA	HC	#8	Female	Closed entry	#8 [10.0]	
FC4008DS/AA-PA781	HC	#8	Female	Closed entry	#8 [10.0]	First
FC4010D/AA	SC	#8	Female	Closed entry	#10 [5.3]	
FC4010D/AA-PA781	SC	#8	Female	Closed entry	#10 [5.3]	First
FC4010DS/AA	HC	#8	Female	Closed entry	#10 [5.3]	
FC4010DS/AA-PA781	HC	#8	Female	Closed entry	#10 [5.3]	First
FC4012D/AA	SC	#8	Female	Closed entry	#12 [4.0]	
FC4012D/AA-PA781	SC	#8	Female	Closed entry	#12 [4.0]	First
FC4012DS/AA	HC	#8	Female	Closed entry	#12 [4.0]	
FC4012DS/AA-PA781	HC	#8	Female	Closed entry	#12 [4.0]	First
FC4016D/AA	SC	#8	Female	Closed entry	#16 [1.5]	
FC4016D/AA-PA781	SC	#8	Female	Closed entry	#16 [1.5]	First
FC4016DS/AA	HC	#8	Female	Closed entry	#16 [1.5]	
FC4016DS/AA-PA781	HC	#8	Female	Closed entry	#16 [1.5]	First
MC4008DS/AA	HC	#8	Male	n/a	#8 [10.0]	
MC4008DS/AA-PA781	HC	#8	Male	n/a	#8 [10.0]	First
MC4010D/AA	SC	#8	Male	n/a	#10 [5.3]	
MC4010D/AA-PA781	SC	#8	Male	n/a	#10 [5.3]	First
MC4010DS/AA	HC	#8	Male	n/a	#10 [5.3]	
MC4010DS/AA-PA781	HC	#8	Male	n/a	#10 [5.3]	First
MC4012D/AA	SC	#8	Male	n/a	#12 [4.0]	
MC4012D/AA-PA781	SC	#8	Male	n/a	#12 [4.0]	First
MC4012DS/AA	HC	#8	Male	n/a	#12 [4.0]	
MC4012DS/AA-PA781	HC	#8	Male	n/a	#12 [4.0]	First
MC4016D/AA	SC	#8	Male	n/a	#16 [1.5]	
MC4016D/AA-PA781	SC	#8	Male	n/a	#16 [1.5]	First
MC4016DS/AA	HC	#8	Male	n/a	#16 [1.5]	
MC4016DS/AA-PA781	HC	#8	Male	n/a	#16 [1.5]	First
FC1210P2/AA	SC	#12	Female	Closed entry	#10 [6.0]	
FC1210P2S/AA	HC	#12	Female	Closed entry	#10 [6.0]	
FC1212P2/AA	SC	#12	Female	Closed entry	#12 [4.0]	
FC1212P2S/AA	HC	#12	Female	Closed entry	#12 [4.0]	
MC1210N/AA-PA563	SC	#12	Male	n/a	#10 [6.0]	First
MC1210NS/AA-PA563	HC	#12	Male	n/a	#10 [6.0]	First
MC1210N/AA	SC	#12	Male	n/a	#10 [6.0]	
MC1210NS/AA	HC	#12	Male	n/a	#10 [6.0]	
MC1212N/AA-PA563	SC	#12	Male	n/a	#12 [4.0]	First
MC1212NS/AA-PA563	HC	#12	Male	n/a	#12 [4.0]	First
MC1212N/AA	SC	#12	Male	n/a	#12 [4.0]	
MC1212NS/AA	HC	#12	Male	n/a	#12 [4.0]	

## CONTACTS

Contact Technical Sales for more details on additional contact sizes, material, finishes, and termination styles.

SC	Standard conductivity contacts
HC	High conductivity contacts

### REMOVABLE CRIMP CONTACTS

PART NUMBER	SC / HC	Size	Gender	Female Contact Style	Stranded AWG [mm <sup>2</sup> ]	Sequential Mate
FC112P2/AA-PA907	SC	#16	Female	Closed entry	#12 [4.0]	
FC112P2S/AA-PA907	HC	#16	Female	Closed entry	#12 [4.0]	
FC114P2/AA-PA907	SC	#16	Female	Closed entry	#14-16 [2.5-1.5]	
FC116P2/AA-PA907	SC	#16	Female	Closed entry	#16-18-20 [1.5-1.0-0.5]	
FC120P2/AA-PA907	SC	#16	Female	Closed entry	#20-22-24 [0.5-0.3-0.25]	
MC112N/AA-133.5	SC	#16	Male	n/a	#12 [4.0]	First
MC112NS/AA-133.5	HC	#16	Male	n/a	#12 [4.0]	First
MC112N/AA	SC	#16	Male	n/a	#12 [4.0]	
MC112NS/AA	HC	#16	Male	n/a	#12 [4.0]	
MC114N/AA-133.5	SC	#16	Male	n/a	#14-16 [2.5-1.5]	First
MC114N/AA	SC	#16	Male	n/a	#14-16 [2.5-1.5]	
MC116N/AA-133.5	SC	#16	Male	n/a	#16-18-20 [1.5-1.0-0.5]	First
MC116N/AA	SC	#16	Male	n/a	#16-18-20 [1.5-1.0-0.5]	
MC120N/AA-133.5	SC	#16	Male	n/a	#20-22-24 [0.5-0.3-0.25]	First
MC120N/AA	SC	#16	Male	n/a	#20-22-24 [0.5-0.3-0.25]	
FC1816P2/AA	SC	#18	Female	Closed entry	#16-18 [1.5-1.0]	
FC1816P2S/AA	HC	#18	Female	Closed entry	#16-18 [1.5-1.0]	
FC1820P2/AA	SC	#18	Female	Closed entry	#20 [0.5]	
FC1820P2S/AA	HC	#18	Female	Closed entry	#20 [0.5]	
MC1816N/AA-PA561	SC	#18	Male	n/a	#16-18 [1.5-1.0]	First
MC1816NS/AA-PA561	HC	#18	Male	n/a	#16-18 [1.5-1.0]	First
MC1816N/AA	SC	#18	Male	n/a	#16-18 [1.5-1.0]	
MC1816NS/AA	HC	#18	Male	n/a	#16-18 [1.5-1.0]	
MC1820N/AA-PA561	SC	#18	Male	n/a	#20 [0.5]	First
MC1820NS/AA-PA561	HC	#18	Male	n/a	#20 [0.5]	First
MC1820N/AA	SC	#18	Male	n/a	#20 [0.5]	
MC1820NS/AA	HC	#18	Male	n/a	#20 [0.5]	
FC422P9/AA	SC	#22	Female	Closed entry	#22-26 [0.3-0.12]	
MC422N9/AA	SC	#22	Male	n/a	#22-26 [0.3-0.12]	
MC422N9/AA-PA1116**1	SC	#22	Male	n/a	#22-26 [0.3-0.12]	

\*\*1 For use with alignment insert.

### NON-REMOVABLE HYPERBOLOID CRIMP CONTACTS

PART NUMBER	SC / HC	Size	Gender	Female Contact Style	Stranded AWG [mm <sup>2</sup> ]
FC3124T	SC	0.60 [0.236]	Female	Closed entry	#24-28 [0.25-0.08]
MC3124T	SC	0.60 [0.236]	Male	n/a	#24-28 [0.25-0.08]

## CONTACTS

Contact Technical Sales for more details on additional contact sizes, material, finishes, and termination styles.

<b>SC</b>	Standard conductivity contacts
<b>HC</b>	High conductivity contacts

### REMOVABLE CONTACTS, BUS BAR INTERNAL THREADS

PART NUMBER	SC / HC	Size	Gender	Female Contact Style	Thread
SPFIT04M/AA	SC	#4	Female	Closed entry	M5 x 0.8
SPFIT04MS/AA	HC	#4	Female	Closed entry	M5 x 0.8
SPFIT04S/AA	SC	#4	Female	Closed entry	10-24 UNC 2B
SPFIT04SS/AA	HC	#4	Female	Closed entry	10-24 UNC 2B
SPMIT04M/AA	SC	#4	Male	n/a	M5 x 0.8
SPMIT04MS/AA	HC	#4	Male	n/a	M5 x 0.8
SPMIT04S/AA	SC	#4	Male	n/a	10-24 UNC 2B
SPMIT04SS/AA	HC	#4	Male	n/a	10-24 UNC 2B

Scale 1:1

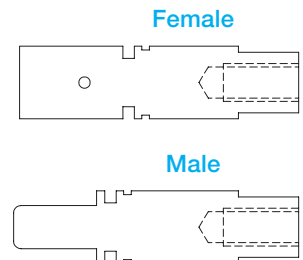

### REMOVABLE CONTACTS, BUS BAR EXTERNAL THREADS

PART NUMBER	SC / HC	Size	Gender	Female Contact Style	Thread
SPFET04M/AA	SC	#4	Female	Closed entry	M5 x 0.8
SPFET04MS/AA	HC	#4	Female	Closed entry	M5 x 0.8
SPFET04S/AA	SC	#4	Female	Closed entry	10-24 UNC 2A
SPFET04SS/AA	HC	#4	Female	Closed entry	10-24 UNC 2A
SPMET04M/AA	SC	#4	Male	n/a	M5 x 0.8
SPMET04MS/AA	HC	#4	Male	n/a	M5 x 0.8
SPMET04S/AA	SC	#4	Male	n/a	10-24 UNC 2A
SPMET04SS/AA	HC	#4	Male	n/a	10-24 UNC 2A

Scale 1:1

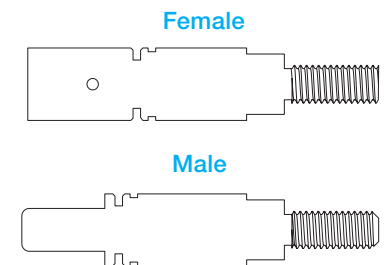

### REMOVABLE CONTACTS, RIGHT ANGLE THREAD FOR RING TERMINAL

PART NUMBER	SC / HC	Size	Gender	Female Contact Style	Thread	Stranded AWG [mm <sup>2</sup> ]
SPFRA04M/AA	SC	#4	Female	Closed entry	M5 x 0.8	#10 [5.3]
SPFRA04MS/AA	HC	#4	Female	Closed entry	M5 x 0.8	#10 [5.3]
SPFRA04S/AA	SC	#4	Female	Closed entry	10-24 UNC 2B	#10 [5.3]
SPFRA04SS/AA	HC	#4	Female	Closed entry	10-24 UNC 2B	#10 [5.3]
SPMRA04M/AA	SC	#4	Male	n/a	M5 x 0.8	#10 [5.3]
SPMRA04MS/AA	HC	#4	Male	n/a	M5 x 0.8	#10 [5.3]
SPMRA04S/AA	SC	#4	Male	n/a	10-24 UNC 2B	#10 [5.3]
SPMRA04SS/AA	HC	#4	Male	n/a	10-24 UNC 2B	#10 [5.3]

Scale 1:1

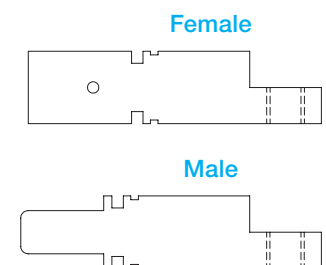

TOOLING

Contact Extraction Tool



Contact Insertion Tool



Hand Crimp Tool



CONTACT SIZE	Contact Extraction Tool	Contact Insertion Tool	Hand Crimp Tool
Size 4	Not Applicable	Not Applicable	Pneumatic crimp tool P/N 9503-2-1-0 with 9503-2-2-0 and 9503-2-4-0 (FC0404** and MC0404**)
Size 8	4311-0-2-0	Not Applicable	9504-19-0-0 (FC4008DS and MC4008DS contacts) 9509-0-0-0 (*C4010D, *C4012D, and *C4016D contacts)
Size 12	2711-0-0-0	9099-3-0-0	9509-6-1-0 with 9509-6-2-0 positioner (*C1210** contacts) 9501-0-0-0 with 9502-38-0-0 positioner (MC1212** contacts) 9501-0-0-0 with 9502-37-0-0 positioner (FC1212** contacts)
Size 16	9081-0-0-0	9099-0-0-0	9501-0-0-0 with 9502-1-0-0 positioner (FC1**P2, MC1**N) 9501-0-0-0 with 9502-17-0-0 positioner (MC1**N-133.5) 9509-3-0-0 (FC112N2S, MC112NS and MC112NS-133.5)
Size 18	9081-9-0-0	9099-6-0-0	9507-0-0-0 with 9502-32-0-0 positioner (male contacts) 9507-0-0-0 with 9502-30-0-0 positioner (female contacts)
Size 22	*1 9081-3-0-0	9099-7-0-0	9507-0-0-0 with 9502-12-0-0 positioner (male contacts) 9507-0-0-0 with 9502-13-0-0 positioner (female contacts)
Hyperboloid 0.6mm	Not Applicable	9512-106-0-0	9507-0-0-0 with 9502-40-0-0 positioner (male contacts) 9507-0-0-0 with 9502-46-0-0 positioner (female contacts)

\*1 Not applicable for size 22 non-removable crimp contacts.  
Consult Technical Sales for additional crimping tools and crimping information.

## OVERALL LENGTH (OAL)

### HOW TO CALCULATE OAL

The overall length (OAL) of a Scorpion connector is the sum of all the modules' lengths. Refer to the example below for calculating the OAL of a sample Scorpion connector. See page 8-10 for individual module dimensions.

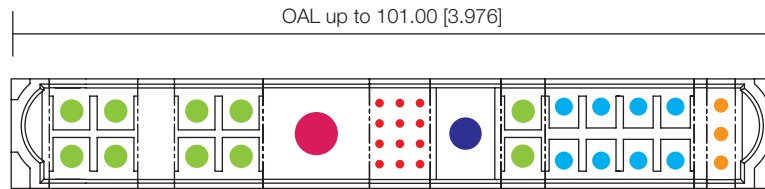



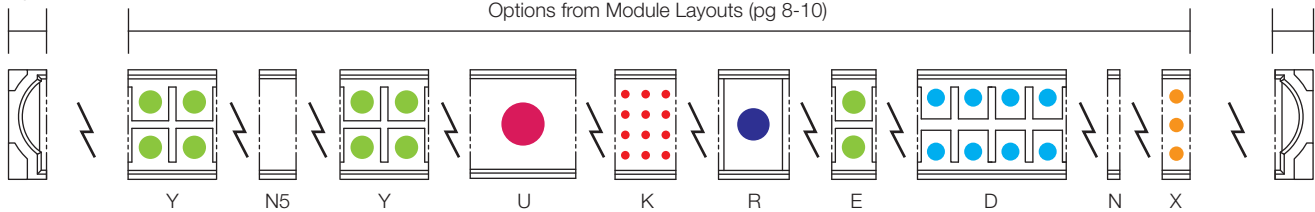

Option from  
Body Style  
(pg 6)

Options from Module Layouts (pg 8-10)



See [connectpositronic.com/Scorpion](https://connectpositronic.com/Scorpion) for all other Scorpion-related information including:

- ✓ **Footprints** 
- ✓ **Tooling** 
- ✓ **Product updates** 
- ✓ **Detailed dimensions** 
- ✓ **2D/3D drawings** 

All dimensional tolerances are  $\pm 0.38$  [0.015], unless otherwise specified:  $\pm 0.03$  mm [0.001 inches] for male contact mating diameters;  $\pm 0.08$  mm [0.003 inches] for contact termination diameters;  $\pm 0.13$  mm [0.005 inches] for all other diameters;  $\pm 0.38$  mm [0.015 inches] for all other dimensions. Dimensions are in millimeter [inches]. All dimensions are subject to change. Product pictures may not be identical in appearance to actual production parts.

Information in this catalog is proprietary to Positronic and its subsidiaries. Positronic believes the data contained herein to be reliable. Since the technical information is given free of charge, the user employs such information at his own discretion and risk. Positronic assumes no responsibility for results obtained or damages incurred from use of such information in whole or in part.

The following trademarks are owned by Positronic Industries, Inc.: Positronic Industries, Inc.®, Positronic®, Connector Excellence®, P+ logo®, PosiBand®, PosiShop®, Optik-D™, and The Science of Certainty®. The color blue as it appears on various connectors is a trademark of Positronic Industries, Inc., Registered in U.S. Patent and Trademark Office.

Products described within this catalog may be protected by one or more of the following US patents:

#4,900,261 #5,255,580 #5,329,697 #6,260,268  
#6,835,079 #7,115,002 #8,944,697 #9,304,263

Patented in Canada, 1992 Other patents pending

**Federal Supply Code for Manufacturers**

Positronic Industries: 28198  
Positronic Industries SAS: FA7Y0  
Positronic Asia PTE LTD: QB952

**Positronic | Americas**

1325 N Eldon Ave  
Springfield MO 65803 USA  
+1 800 641 4054  
info@connectpositronic.com

**Positronic | Europe**

46 route d'Engachies  
F-32020 Auch Cedex 9 France  
+33 5 6263 4491  
contact@connectpositronic.com

**Positronic | Asia**

3014A Ubi Rd 1 #07-01  
Singapore 408703  
+65 6842 1419  
singapore@connectpositronic.com

**Sales Offices**

Positronic has local sales representation all over the world. For the nearest sales office visit [www.connectpositronic.com/sales](https://www.connectpositronic.com/sales)