

MC44005A6W-SPTLYS-V2	4 x 40	5mm Character Height	LCD Module
<b>Specification</b>			
Version: 1		Date: 03/08/2022	
<b>Revision</b>			
1	02/08/2022	First Issue	

Display Features		
Character Count	4 x 40	
Appearance	Black on Yellow/Green	
Logic Voltage	5V	
Interface	SPI	
Font Set	English / Japanese	
Display Mode	Transflective	
Character Height	4.89mm	
LC Type	STN	
Module Size	190.00 x 54.00 x 13.00 mm	
Operating Temperature	-20°C ~ +70°C	
Construction	COB	Box Quantity
LED Backlight	Yellow/Green	Weight / Display
		---
		---



Display Accessories	
Part Number	Description
MCCMDB-16SIL	LCD Interconnect board, can be driven from either a PC or a single Board computer with a USB output.
MCCBL1A16SLIP-16DILS-150	16 Way, Single in-line to Dual In-line connector Cable.
MCCBL1A16SLIP-16SILS-150	16 Way, Single in-line to Single In-line connector Cable.

Optional Variants		
Fonts	Appearances	Voltage
English/Japanese	Black on Yellow/Green	3V
English/Euro	White on Blue	3.3V
English/Cyrillic	Black on White	5V
	Black on RGB	



## FEATURES

AVAILABLE OPTIONS	CHARACTERISTICS
DISPLAY FORMAT	40 Characters by 4 Lines
POLARIZER OPTIONS	Positive Transflective
BACKLIGHT TYPE OPTIONS	Edge Type LED Backlight (Long life span version)
BACKLIGHT COLOR OPTIONS	Yellow-Green color
LCD PANEL OPTIONS	Yellow-Green STN
VIEWING ANGLE OPTIONS	6:00 ( Bottom )
TEMPERATURE RANGE OPTIONS	-20°C ~ 70°C, Single Supply Voltage
SUGGESTED DRIVING VOLTAGE	V <sub>lcm</sub> = 5.0V V <sub>led</sub> = 5.0V
SUGGESTED LED DRIVING MODE	PIN17: LED+, PIN18:LED-
CONTROLLER	SPI controller
FONT MAP CODE	E Version
DRIVING DUTY	1/16
DRIVING BIAS	1/5

## MECHANICAL SPECIFICATIONS

<b>OVERALL SIZE</b>	190.0W x 54.0H	mm	<b>THICKNESS</b>	max 13.0	mm
<b>VIEWING AREA</b>	147.0W x 29.5H	mm	<b>HOLE-HOLE</b>	183.0W x 47.0H	mm
<b>CHARACTER SIZE</b>	2.78W x 4.89H	mm	<b>CHARACTER PITCH</b>	0.75W x 1.20H	mm
<b>DOT SIZE</b>	0.50W x 0.55H	mm	<b>DOT PITCH</b>	0.07W x 0.07H	mm

## ABSOLUTE MAXIMUM RATINGS

ITEM	SYMBOL	CONDITION	MIN	TYP	MAX	UNIT
POWER SUPPLY ( LOGIC)	V <sub>dd</sub>	25°C	-0.3	—	7.0	V
POWER SUPPLY (LCD)	V <sub>0</sub>	25°C	V <sub>dd</sub> -13.5	—	V <sub>dd</sub> +0.3	V
INPUT VOLTAGE	V <sub>in</sub>	25°C	-0.3	—	V <sub>dd</sub> +0.3	V
OPERATING TEMPERATURE	V <sub>opr</sub>	—	-20	—	70	°C
STORAGE TEMPERATURE	V <sub>stg</sub>	—	-30	—	80	°C

## ELECTRONIC CHARACTERISTICS

ITEM	SYMBOL	CONDITION	MIN	TYP	MAX	UNIT
INPUT VOLTAGE	V <sub>lcm</sub> = V <sub>dd</sub>	—	—	5.0	—	V
SUPPLY CURRENT	I <sub>dd</sub>	V <sub>dd</sub> =5V	—	1.5	—	mA
DRIVING VOLTAGE FOR LCD PANEL	V <sub>lcd</sub> = (V <sub>dd</sub> - V <sub>0</sub> )	-20°C	3.90	—	4.30	V
		0°C	4.10	—	4.60	
		25°C	4.20	—	4.70	
		50°C	4.20	—	4.70	
		70°C	4.20	—	4.80	

## LCD CHARACTERISTICS

**FOR STN/FSTN TYPE LCD Panel (TA=25°C, Vlcd=5.0V± 0.5V)**

ITEM	SYMBOL	CONDITION	MIN	TYP	MAX	UNIT
VIEWING ANGLE	$\Phi 2 - \Phi 1$	K=4	40	—	—	deg
	$\theta$		60	—	—	
CONTRAST RATIO	K	—	6	—	—	—
RESPONSE TIME(RISE)	TR	—	—	150	250	ms
RESPONSE TIME(FALL)	TF	—	—	150	250	ms

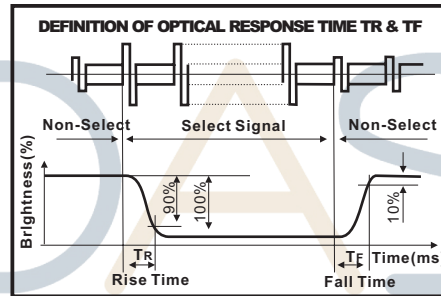
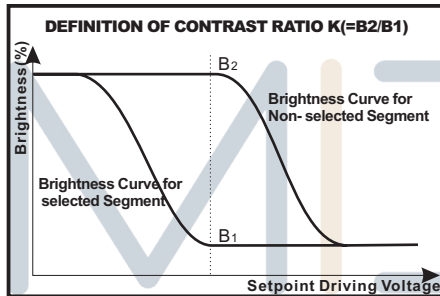
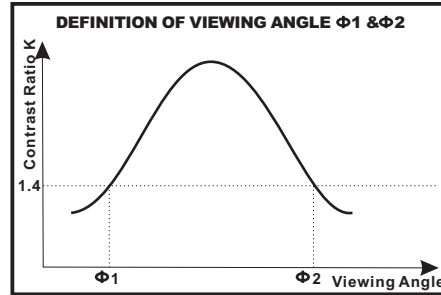
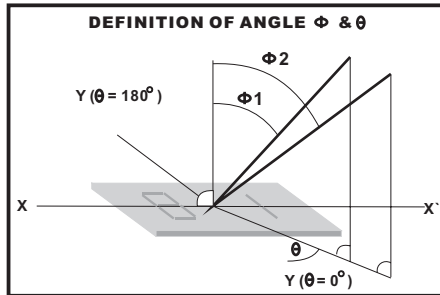

## LED CHARACTERISTICS

ITEM	SYMBOL	CONDITION	MIN	TYP	MAX	UNIT
LED FORWARD VOLTAGE	Vf	25°C If = 2*15mA	2.6	—	3.0	V
LED FORWARD CURRENT	If	25°C	—	30	—	mA
LED REVERSE CURRENT	Ir	25°C Vr=5.0V	—	—	60	μA
LED PEAK WAVE LENGTH	$\lambda_p$	25°C If = 2*15mA	569	—	575	nm
LED BRIGHTNESS (WITHOUT LCD)	Lv	25°C If = 2*15mA	—	310	—	cd/m <sup>2</sup>
LED BRIGHTNESS UNIFORMITY	Lvmin/Lvmax	25°C If = 2*15mA	70	—	—	Ratio
LED LIFE TIME	—	25°C If = 2*15mA	20K	—	—	Hours



## PIN ASSIGNMENT

PIN	SYMBOL	DESCRIPTION	REMARKS
1	SID	Serial data input	
2	SCLK	Serial clock input	
3	CS1	Chip select	
4	NC	No connection	
5	NC	No connection	
6	NC	No connection	
7	NC	No connection	
8	NC	No connection	
9	NC	No connection	
10	NC	No connection	
11	RS	Register Select Signal	
12	V0	Contrast Adjust	
13	Vss	GND	
14	Vdd	Power supply for LCM	5.0V
15	CS2	Chip select	
16	NC	No connection	
17	LED+	Power supply for BKL	5.0V
18	LED-	Power supply for BKL	

### BLOCK DIAGRAM

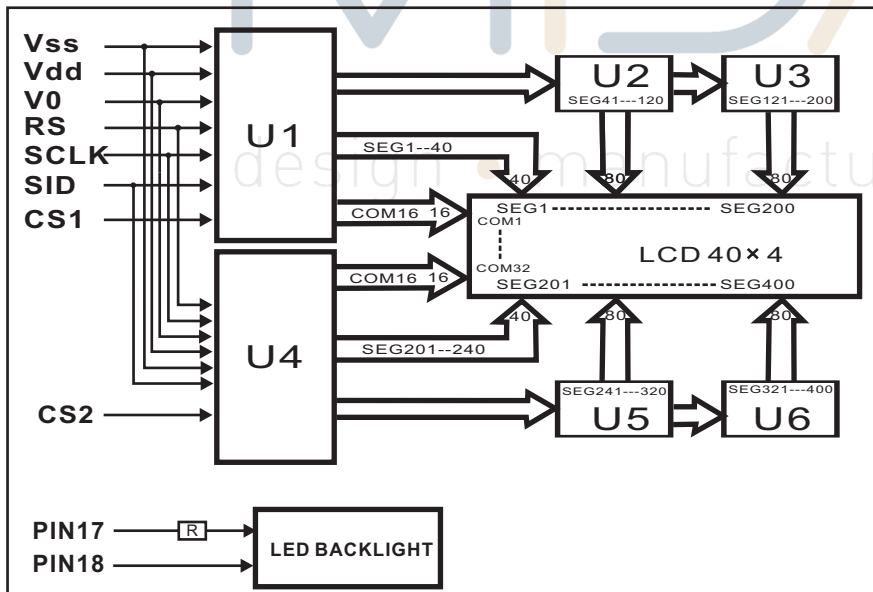

### POWER SUPPLY DIAGRAM

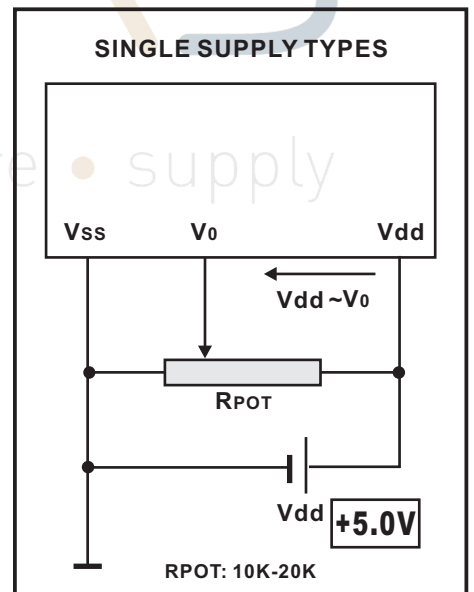

Upper 4bit Lower 4bit	LLLL	LLLH	LLHL	LLHH	LHLL	LHLH	LHHL	LHHH	HLLL	HLLH	HLHL	HLHH	HHLL	HHLH	HHHL	HHHH
LLLL	CG RAM (1)															
LLLH	(2)															
LLHL	(3)															
LLHH	(4)															
LHLL	(5)															
LHLH	(6)															
LHHL	(7)															
LHHH	(8)															
HLLL	(1)															
HLLH	(2)															
HLHL	(3)															
HLHH	(4)															
HHLL	(5)															
HHLH	(6)															
HHHL	(7)															
HHHH	(8)															



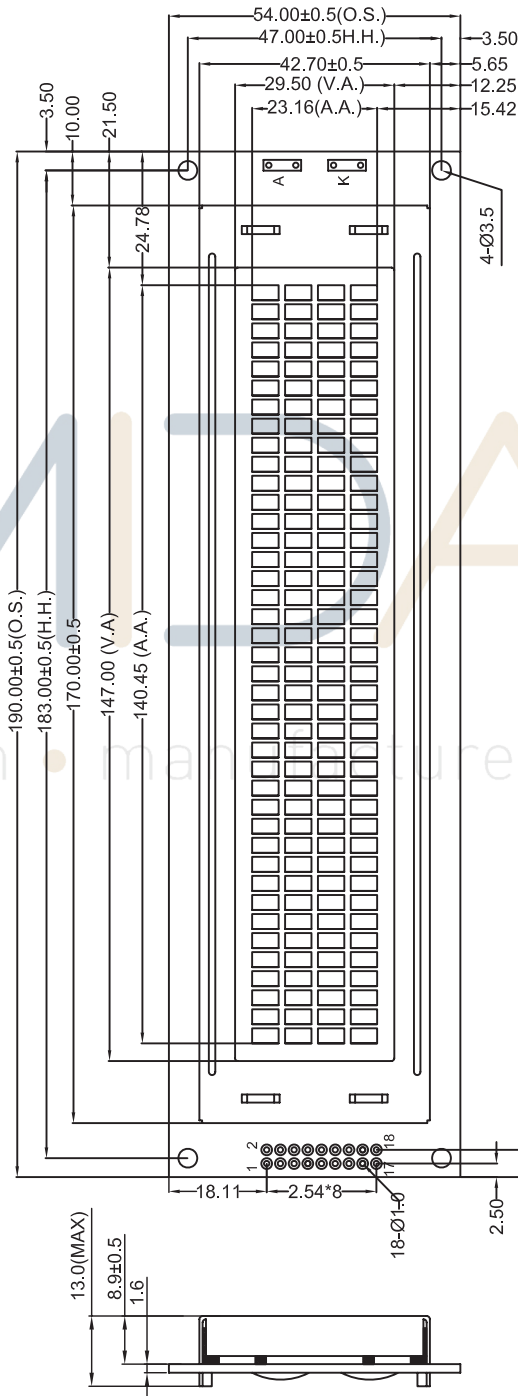
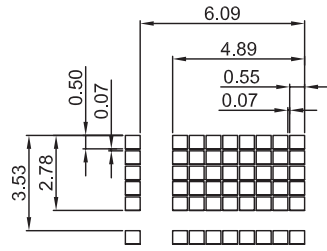

design • manufacture • supply

