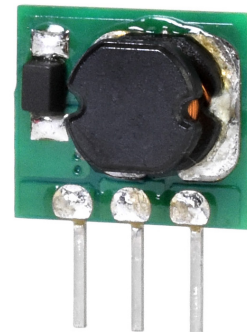

**SERIES: PX078-500-S | DESCRIPTION: NON-ISOLATED DC SWITCHING REGULATOR**
**FEATURES**

- economical open-frame design
- designed to meet EN/BS 62368
- no-load input current as low as 0.2 mA
- supports negative output
- output short circuit protection
- designed to meet EN IEC 62368-1 & BS EN IEC 62368-1

**MODEL**

MODEL	input voltage <sup>1</sup>		output voltage (Vdc)	output current max (mA)	output power max (W)	ripple & noise <sup>2</sup> max (mVp-p)	efficiency <sup>3</sup> typ (%)
	typ (Vdc)	range (Vdc)					
PX07803-500-S	24 12	4.75~36 7~32	3.3 -3.3	500 -300	1.65 0.99	100	85 73
PX07805-500-S	24 12	6.5~36 7~31	5 -5	500 -300	2.5 1.5	100	90 76
PX07806-500-S	24 12	8~36 7~29	6.5 -6.5	500 -300	3.25 1.95	100	91 76
PX07809-500-S	24 12	12~36 8~27	9 -9	500 -150	4.5 1.35	100	93 83
PX07812-500-S	24 12	15~36 8~24	12 -12	500 -150	6.0 1.8	100	94 85
PX07815-500-S	24 12	19~36 8~21	15 -15	500 -150	7.5 2.25	100	95 80

Notes: 1. For input voltages higher than 30 Vdc, a 22  $\mu$ F / 50 V input capacitor is required.  
 2. Tested at nominal input, 20~100%, 20 MHz bandwidth.  
 At loads below 20%, the max ripple and noise will be 300 mVp-p max.  
 4. All specifications are measured at Ta=25°C, humidity < 75%, nominal input voltage, and rated output load unless otherwise specified.

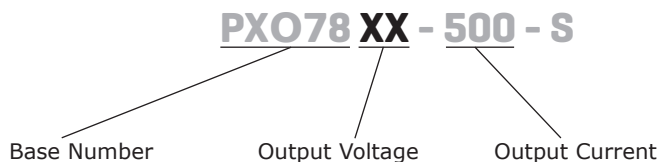
**PART NUMBER KEY**

## INPUT

parameter	conditions/description	min	typ	max	units
input reverse polarity protection	no				
no-load input current	positive output at nominal input voltage		0.2	1.5	mA
	negative output at nominal input voltage		1	10	mA
filter	capacitor filter				

## OUTPUT

parameter	conditions/description	min	typ	max	units
maximum capacitive load	positive output			680	$\mu$ F
	negative output			330	$\mu$ F
voltage accuracy	at full load, input voltage range		$\pm 2$	$\pm 4$	%
	3.3 Vdc output model		$\pm 2$	$\pm 3$	%
	all other models		$\pm 2$	$\pm 3$	%
line regulation	at full load, input voltage range		$\pm 0.2$	$\pm 0.5$	%
load regulation	at nominal input, 0~100% load		$\pm 0.3$	$\pm 1$	%
switching frequency	at nominal input voltage, full load		700		kHz
transient recovery time	at nominal input voltage, 25% load step change		0.2	1	ms
transient response deviation	at nominal input voltage, 25% load step change		$\pm 50$	$\pm 250$	mV
temperature coefficient	operating temperature -40°C~80°C		$\pm 0.02$		%/°C

## PROTECTIONS

parameter	conditions/description	min	typ	max	units
short circuit protection	continuous, auto recovery				

## SAFETY AND COMPLIANCE

parameter	conditions/description	min	typ	max	units
safety approvals	designed to meet 62368: EN/IEC				
conducted emissions	CISPR32/EN55032 CLASS B (see Fig. 5-2 for recommended circuit)				
radiated emissions	CISPR32/EN55032 CLASS B (see Fig. 5-2 for recommended circuit)				
ESD	IEC/EN 61000-4-2 Contact $\pm 4$ kV, perf. Criteria B				
radiated immunity	IEC/EN 61000-4-3 10V/m, perf. Criteria A				
EFT/burst	IEC/EN 61000-4-4 $\pm 1$ kV (see Fig. 5-1 for recommended circuit), perf. Criteria B				
surge	IEC/EN 61000-4-5 line to line $\pm 1$ kV (see Fig. 5-1 for recommended circuit, perf. Criteria B				
conducted immunity	IEC/EN 61000-4-6 3 Vrms, perf. Criteria A				
MTBF	as per MIL-HDBK-217F, 25°C	2,000,000			hours
RoHS	yes				

## ENVIRONMENTAL

parameter	conditions/description	min	typ	max	units
operating temperature	see derating curve	-40		85	°C
storage temperature		-55		125	°C
storage humidity	non-condensing	5		95	%

## SOLDERABILITY

parameter	conditions/description	min	typ	max	units
pin soldering resistance temperature	soldering time: 10 seconds			260	°C

## MECHANICAL

parameter	conditions/description	min	typ	max	units
dimensions	10.27 x 6.00 x 8.61 [0.404 x 0.236 x 0.339 inch]				mm
weight			0.6		g
cooling method	natural convection				

## MECHANICAL DRAWING

units: mm [inch]  
 tolerance:  $\pm 0.50 [\pm 0.020]$   
 pin section tolerance:  $\pm 0.20 [\pm 0.008]$

PIN-OUT		
PIN	POSITIVE OUTPUT	NEGATIVE OUTPUT
	FUNCTION	FUNCTION
1	Vin	Vin
2	GND	-Vout
3	Vout	GND

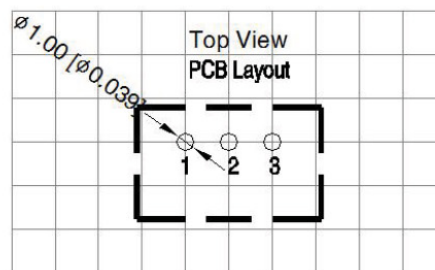
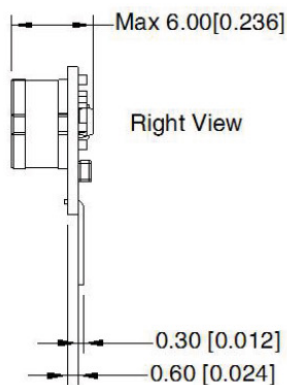
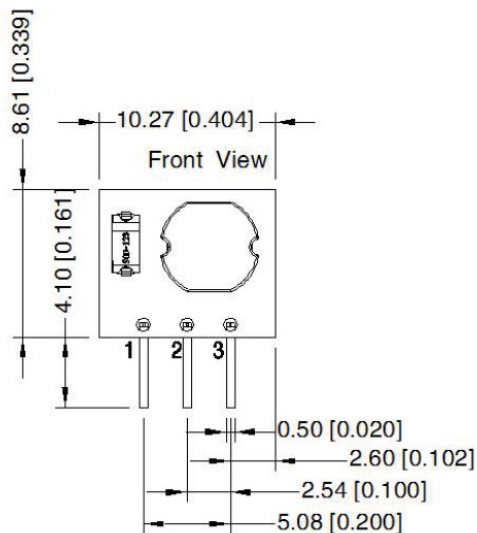

Note: Grid 2.54\*2.54mm

## DERATING CURVE

Figure 1

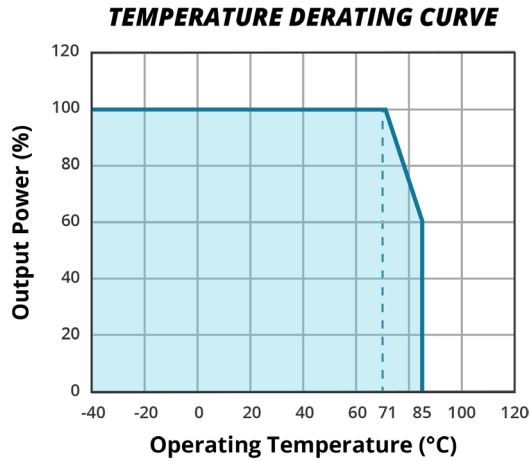

## EFFICIENCY CURVES

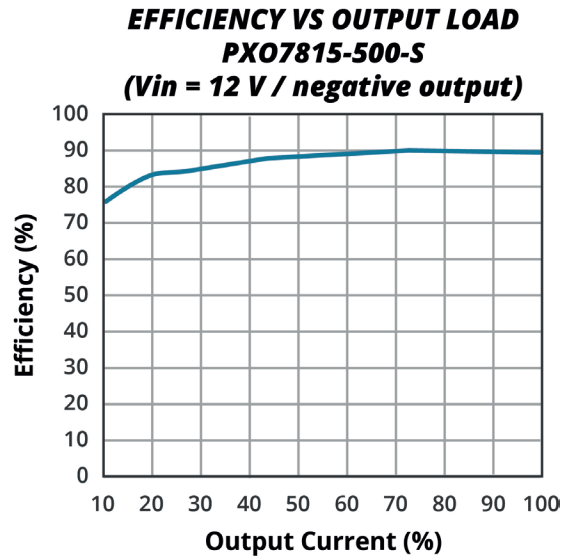
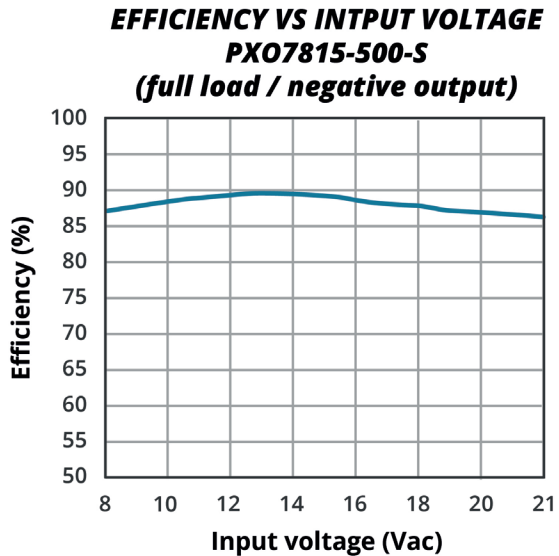
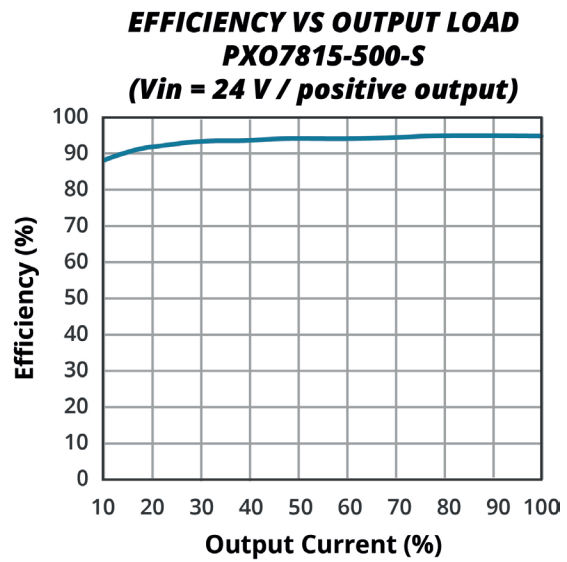
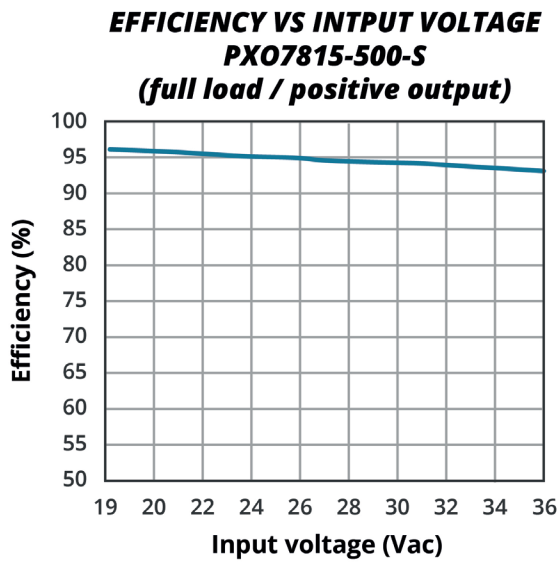

## TYPICAL APPLICATION CIRCUIT

Figure 2

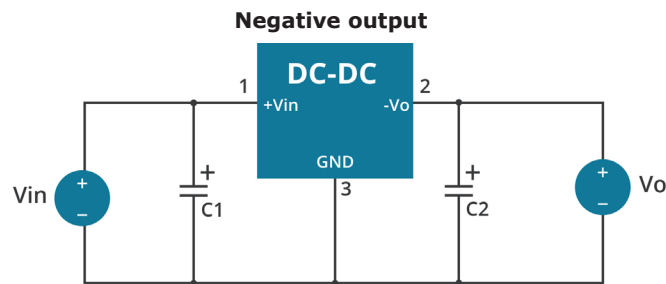
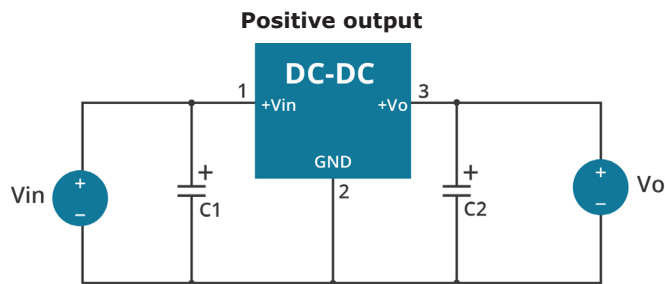

Figure 3

### Positive output and Negative output

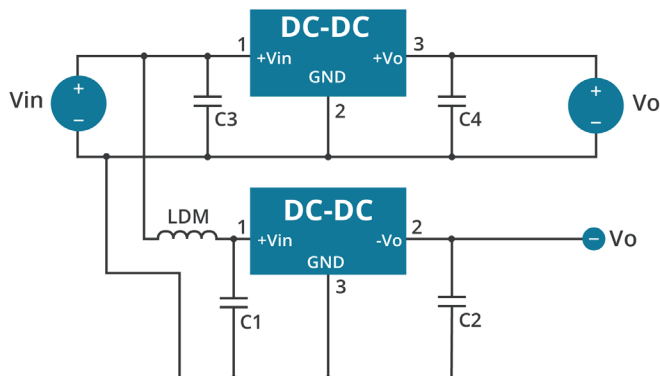

Table 1

Model Number	C1/C3 (ceramic capacitor)	C2/C4 (ceramic capacitor)
PX07803-500-S	10 $\mu$ F/50 V	22 $\mu$ F/10 V
PX07805-500-S	10 $\mu$ F/50 V	22 $\mu$ F/10 V
PX07806-500-S	10 $\mu$ F/50 V	22 $\mu$ F/16 V
PX07809-500-S	10 $\mu$ F/50 V	22 $\mu$ F/16 V
PX07812-500-S	10 $\mu$ F/50 V	22 $\mu$ F/25 V
PX07815-500-S	10 $\mu$ F/50 V	22 $\mu$ F/25 V

- Note:
1. The required capacitors C1 and C2 (C3 and C4) must be connected as close as possible to the terminals of the module.
  2. Refer to Table 1 for C1 and C2 (C3 and C4) capacitor values. For certain applications, increased values and/or tantalum or low ESR electrolytic capacitors may also be used instead.
  3. When using configurations as shown in Figure 3, we recommended to add an inductor (LDM) with a value of up to 10 $\mu$ H which helps reducing mutual interference.
  4. Converter cannot be used for hot swap and with output in parallel.
  5. To further reduce the output ripple and noise, we suggested the use of a "LC" filter at the output terminals, with an inductor value (L) of 10 $\mu$ H-47 $\mu$ H.

Figure 4

### "LC" output filter application

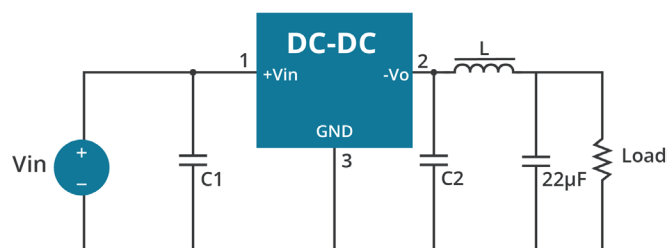
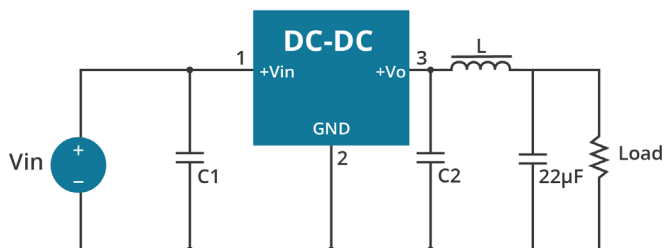

## EMC RECOMMENDED CIRCUIT

Figure 5

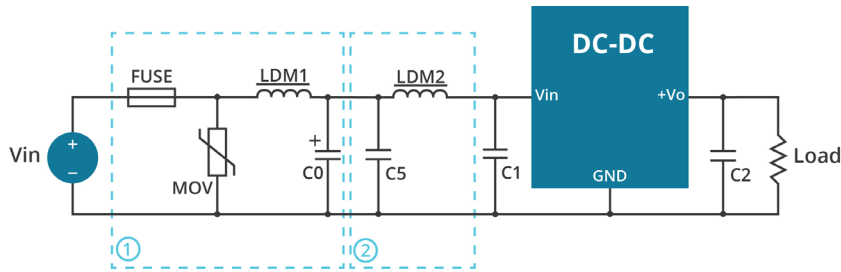

Table 2

Recommended external circuit components	
FUSE	choose according to actual input current
MOV	S20K30
LDM1	82 $\mu$ H
C0	680 $\mu$ F/50 V
C1 / C2	see Table 1
C5	10 $\mu$ F/50 V
LDM2	22 $\mu$ H

Note: For EMC tests we use Part ① in Fig. 5 for immunity and part ② for emissions test. Selecting based on needs.

## REVISION HISTORY

---

rev.	description	date
1.0	initial release	10/18/2022

The revision history provided is for informational purposes only and is believed to be accurate.



**Headquarters**  
20050 SW 112th Ave.  
Tualatin, OR 97062  
**800.275.4899**

Fax 503.612.2383  
**cui.com**  
techsupport@cui.com

CUI offers a two (2) year limited warranty. Complete warranty information is listed on our website.

CUI reserves the right to make changes to the product at any time without notice. Information provided by CUI is believed to be accurate and reliable. However, no responsibility is assumed by CUI for its use, nor for any infringements of patents or other rights of third parties which may result from its use.

CUI products are not authorized or warranted for use as critical components in equipment that requires an extremely high level of reliability. A critical component is any component of a life support device or system whose failure to perform can be reasonably expected to cause the failure of the life support device or system, or to affect its safety or effectiveness.