

XRCGE26M000FBA1BR0

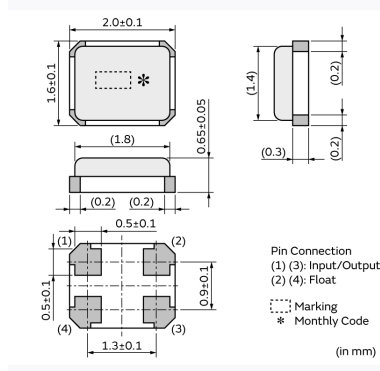

Appearance & Shape

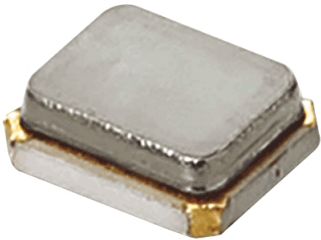

Features

The crystal unit for automotive electronics that realized small package and highly accurate frequency. Based on Murata's excellent package technology and high grade quartz crystal elements, achieving small size and high accuracy unit.

Features

- 1.The series has high reliability and is available for a wide temperature range.
- 2.The crystal unit is small size (2.0 x 1.6 x 0.7 (mm)), and contribute to reduction in mounting area.
- 3.The series complies to RoHS and ELV directives, being lead-free (phase 3).
- 4.The series complies to AEC-Q200.

Applications

Automotive Usage	Powertrain/Safety
Other Usage	Automotive

Packaging Information

Packaging	Specifications	Standard Packing Quantity
R0	180mm Plastic Tape	3000

Attention

- 1.This datasheet is downloaded from the website of Murata Manufacturing Co., Ltd. Therefore, it's specifications are subject to change or our products in it may be discontinued without advance notice. Please check with our sales representatives or product engineers before ordering.
- 2.This datasheet has only typical specifications because there is no space for detailed specifications. Therefore, please review our product specifications or consult the approval sheet for product specifications before ordering.

XRCGE26M000FBA1BR0



Specifications

Product Type	Crystal Unit
Series	XRCGE
Type	HCR2016
Frequency	26.0000MHz
Frequency Tolerance	+/-15ppm max. (25+/-3°C)
Operating Temperature Range	-40°C~125°C
Frequency Shift by Temperature	+/-35ppm max.
Frequency Aging	+/-10ppm max./10years
Equivalent Series Resistance (ESR)	80ohm max.
Drive Level (DL)	300µW max.
Load Capacitance (Cs)	8pF
Shape	SMD
Wash	Not available
L x W (size)	2.0x1.6mm
Mass	6.9mg

Attention

1.This datasheet is downloaded from the website of Murata Manufacturing Co., Ltd. Therefore, it's specifications are subject to change or our products in it may be discontinued without advance notice. Please check with our sales representatives or product engineers before ordering.

2.This datasheet has only typical specifications because there is no space for detailed specifications.

Therefore, please review our product specifications or consult the approval sheet for product specifications before ordering.