

Power Management Switch IC Series for PCs and Digital Consumer Product

Large Current Output Power Management Switch ICs

BD6520F, BD6522F



●Description

The power switch for expansion module is a power management switch having one circuit of N-channel Power MOS FET. The switch realizes 50mΩ(Typ.) ON resistance. The switch turns on smoothly by the built-in charge pump, therefore, it is possible to reduce inrush current at switch on. And soft start control by external capacitor is available.

Further, it has a discharge circuit that discharges electric charge from capacitive load at switch off, Under voltage lockout circuit, and a thermal shutdown circuit.

●Features

- 1) Low on resistance (50mΩ, Typ.) N-MOS switch built in
- 2) Maximum output current: 2A
- 3) Discharge circuit built in
- 4) Soft start control circuit built in
- 5) Under voltage lockout (UVLO) circuit built in
- 6) Thermal shutdown (Output off latching)
- 7) Reverse current flow blocking at switch off (only BD6522F)

●Applications

Notebook PC, PC peripheral device, etc.

●Lineup

Parameter	BD6520F	BD6522F
Supply Voltage	3 to 5.5V	3 to 5.5V
Switch current	2A	2A
On Resistance	50mΩ	50mΩ
OUT Rise Time	2000us	1000us
OUT Fall Time	3us	4us
Package	SOP8	SOP8
Reverse current flow blocking at switch off	-	○

● Absolute Maximum Ratings

Parameter	Symbol	Rating	Unit
Supply Voltage	V _{DD}	-0.3 to 6.0	V
CTRL Input Voltage	V _{CTRL}	-0.3 to 6.0	V
Switch Output Voltage	V _{OUT}	-0.3 to V _{DD} + 0.3 (BD6520F)	V
		-0.3 to 6.0 (BD6522F)	V
Storage temperature	T _{STG}	-55 to 150	°C
Power dissipation	P _d	560*1	mW

*1 This value decreases 4.48mW/°C above Ta=25°C

* Resistance radiation design is not doing.

* Operation is not guaranteed.

● Operation conditions

Parameter	Symbol	Limit	Unit
Supply Voltage	V _{DD}	3.0 to 5.5	V
Switch current	I _{OUT}	0 to 2	A
Operating Temperature	T _{OPR}	-25 to 85	°C

● Electrical characteristics

◎BD6520F (Unless otherwise specified, Ta = 25°C, V_{DD} = 5V)

Parameter	Symbol	Limit			Unit	Condition
		Min.	Typ.	Max.		
On Resistance	R _{ON1}	-	50	70	mΩ	V _{DD} = 5V, V _{CTRL} = 5V
	R _{ON2}	-	60	85	mΩ	V _{DD} = 3V, V _{CTRL} = 3V
Operating Current	I _{DD}	-	110	220	uA	V _{CTRL} = 5V, OUT = OPEN
	I _{DDST}	-	-	2	uA	V _{CTRL} = 0V, OUT = OPEN
Control Input voltage	V _{CTRL} L	-	-	0.7	V	V _{CTRL} L = Low Level
	V _{CTRL} H	2.5	-	-	V	V _{CTRL} H = High Level
Control Input current	I _{CTRL}	-1	0	1	uA	V _{CTRL} = L, H
Turn On Delay	Trd	200	1000	2000	us	RL = 10Ω, SSCTL = OPEN CTRL = L→H → OUT=50%
Turn On Rise Time	Tr	500	2000	7500	us	RL = 10Ω, SSCTL = OPEN CTRL = 10% → 90%
Turn Off Delay	Tfd	-	3	20	us	RL = 10Ω, SSCTL = OPEN CTRL = H→L → OUT=50%
Turn Off Fall Time	Tf	-	1	20	us	RL = 10Ω, SSCTL = OPEN CTRL = 90% → 10%
Discharge Resistance	R _{SWDC}	-	350	600	Ω	V _{DD} = 5V, V _{CTRL} = 0V, V _{OUT} = 5V
UVLO Threshold Voltage	V _{UVLO} H	2.3	2.5	2.7	V	V _{DD} increasing
	V _{UVLO} L	2.1	2.3	2.5	V	V _{DD} decreasing
UVLO Hysteresis Voltage	V _{HYS}	100	200	300	mV	V _{HYS} = V _{UVLO} H - V _{UVLO} L
Thermal Shutdown Threshold	T _{TS}	-	135	-	°C	V _{CTRL} = 5V
SSCTL Output Voltage	V _{SSCTL}	-	13.5	-	V	V _{CTRL} = 5V

©BD6522F (Unless otherwise specified, Ta = 25°C, VDD = 5V)

Parameter	Symbol	Limit			Unit	Condition
		Min.	Typ.	Max.		
On Resistance	R _{ON1}	-	50	70	mΩ	V _{DD} = 5V, V _{CTRL} = 5V
	R _{ON2}	-	60	85	mΩ	V _{DD} = 3.3V, V _{CTRL} = 3.3V
Operating Current	I _{DD}	-	110	220	μA	V _{CTRL} = 5V, OUT = OPEN
	I _{DDST}	-	-	2	μA	V _{CTRL} = 0V, OUT = OPEN
Control Input Voltage	V _{CTRL} L	-	-	0.7	V	V _{CTRL} L = Low Level
	V _{CTRL} H	2.5	-	-	V	V _{CTRL} H = High Level
Control Input Current	I _{CTRL}	-1	0	1	μA	V _{CTRL} = L, H
Turn On Time	T _{ON}	-	1000	3500	μs	RL = 10Ω, SSCTL = OPEN CTRL = H → OUT = 90%
Turn Off Time	T _{OFF}	-	4	20	μs	RL = 10Ω, SSCTL = OPEN CTRL = L → OUT = 10%
Discharge Resistance	R _{SWDC}	-	350	600	Ω	V _{DD} = 5V, V _{CTRL} = 0V
UVLO Threshold Voltage	V _{UVLO} H	2.3	2.5	2.7	V	V _{DD} increasing
	V _{UVLO} L	2.1	2.3	2.5	V	V _{DD} decreasing
UVLO Hysteresis Voltage	V _{HYS}	100	200	300	mV	V _{HYS} = V _{UVLO} H - V _{UVLO} L
Thermal Shutdown Threshold	T _{TS}	-	135	-	°C	V _{CTRL} = 5V
SSCTL Output Voltage	V _{SSCTL}	-	13.5	-	V	V _{CTRL} = 5V

● Measurement circuit

©BD6520F

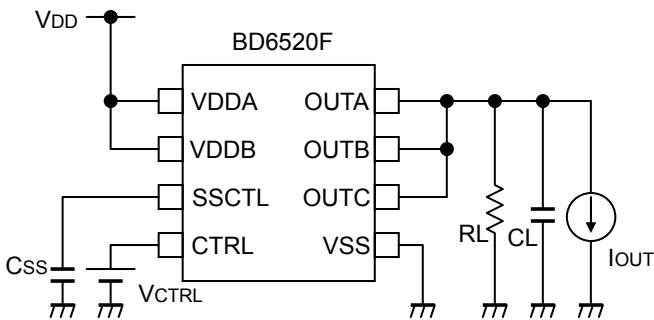

©BD6522F

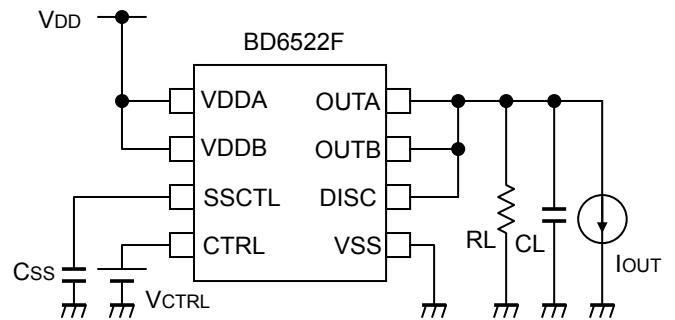
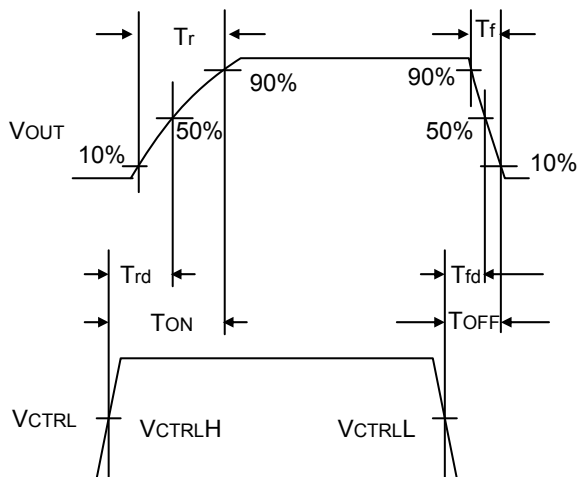

Fig.1 Measurement circuit

● Timing diagram

©BD6520F



©BD6522F

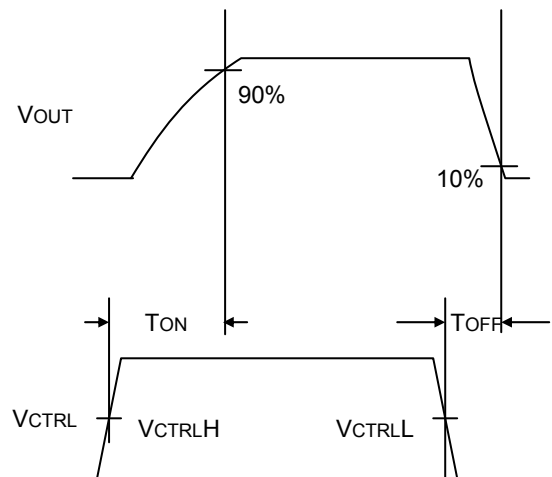

Fig.2 Timing diagram

● Typical characteristics

◎BD6520F

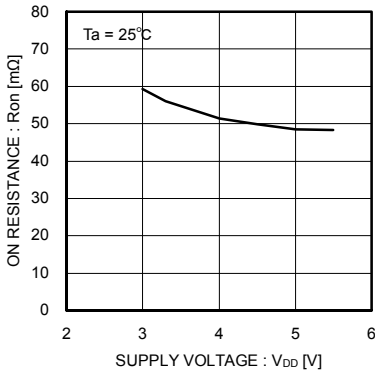

Fig.3 On resistance

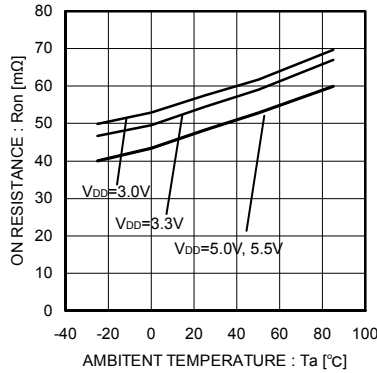

Fig.4 On resistance

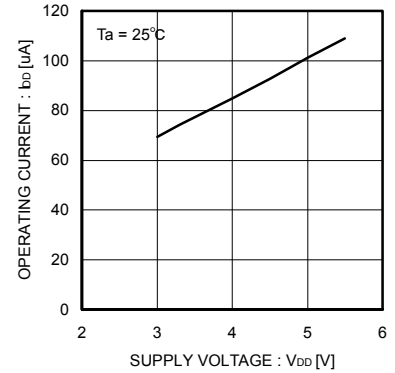

Fig.5 Operating current (CTRL enable)

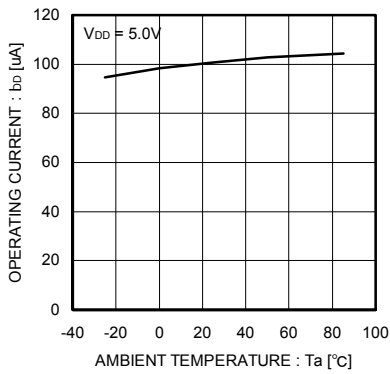

Fig.6 Operating current (CTRL enable)

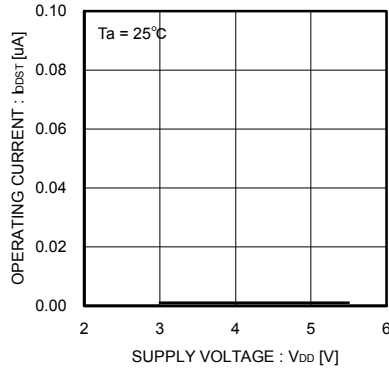

Fig.7 Operating current (CTRL disable)

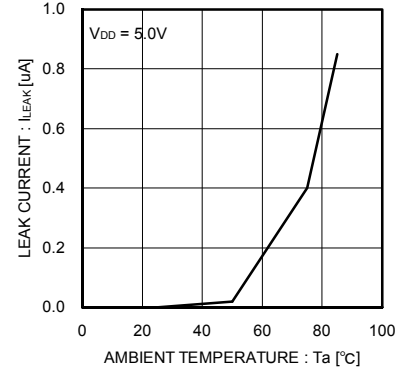

Fig.8 Leak current

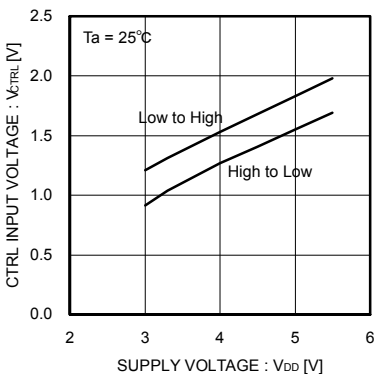

Fig.9 CTRL input voltage

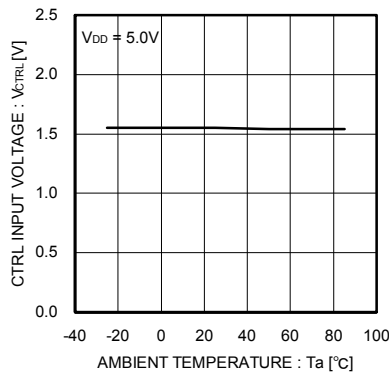

Fig.10 CTRL input voltage H→L

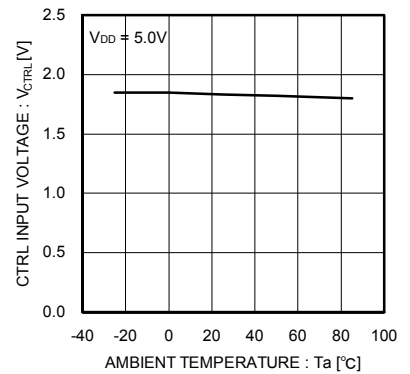

Fig.11 CTRL input voltage L→H

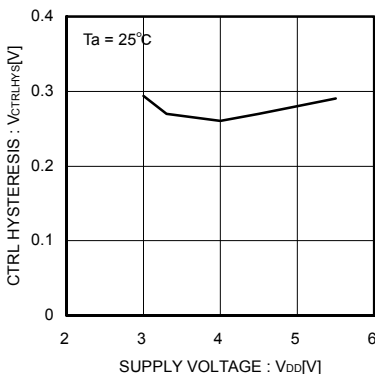

Fig.12 CTRL hysteresis voltage

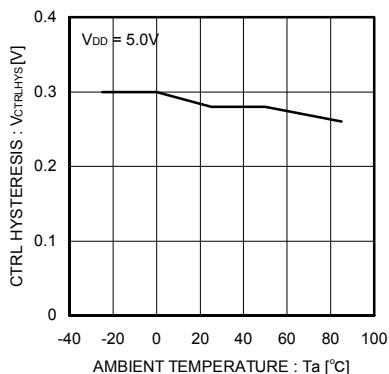

Fig.13 CTRL hysteresis voltage

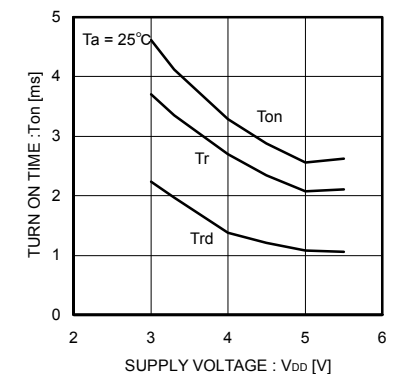

Fig.14 Turn On Rise time

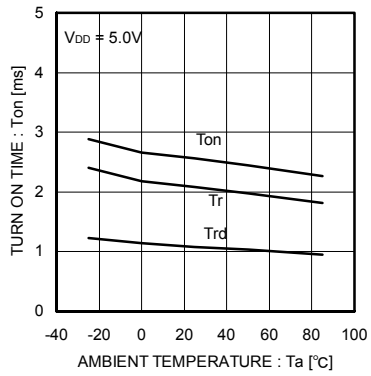

Fig.15 Turn On Rise time

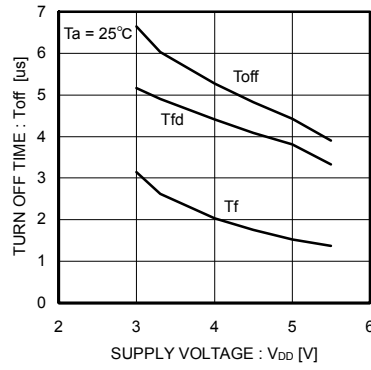

Fig.16 Turn Off Fall time

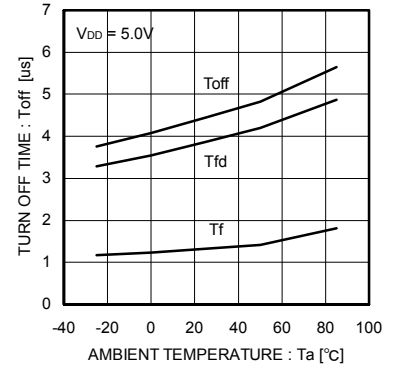

Fig.17 Turn Off Fall time

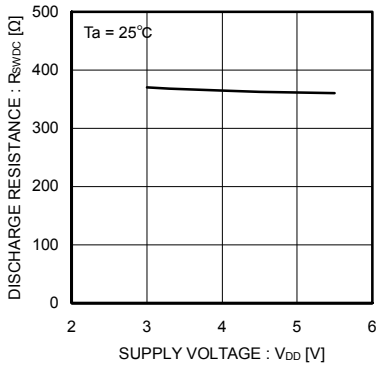

Fig.18 Switch discharge resistance

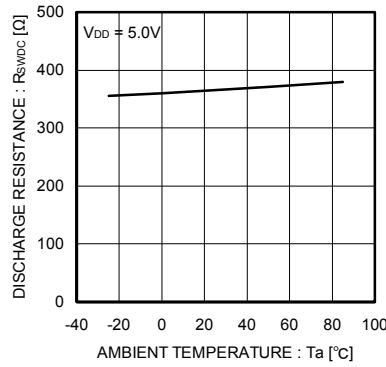

Fig.19 Switch discharge resistance

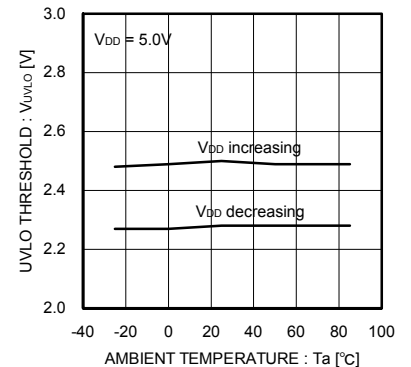

Fig.20 UVLO threshold voltage

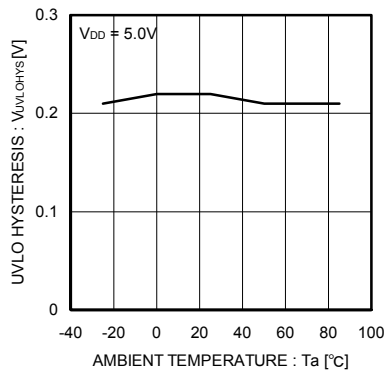

Fig.21 UVLO hysteresis voltage

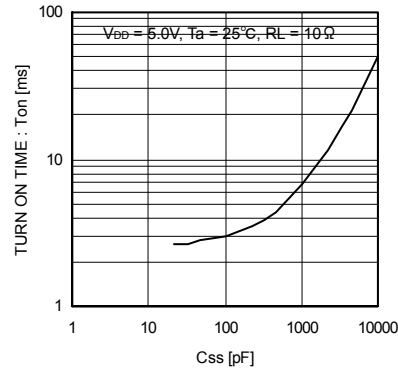

Fig.22 Turn On Rise time (vs. Coss)

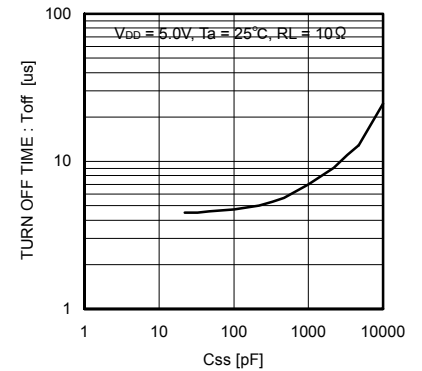

Fig.23 Turn Off Fall time (vs. Coss)

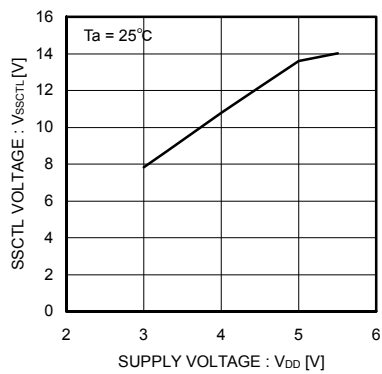

Fig.24 SSCTL output voltage

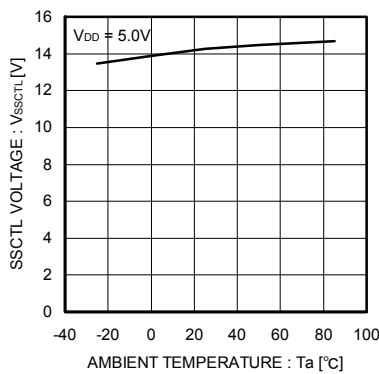

Fig.25 SSCTL output voltage

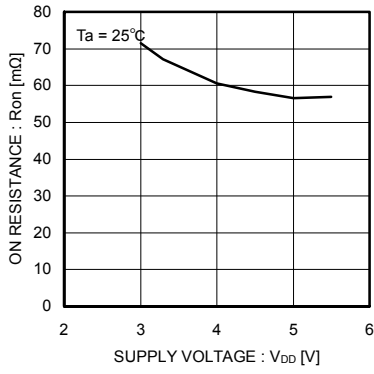

Fig.26 ON resistance

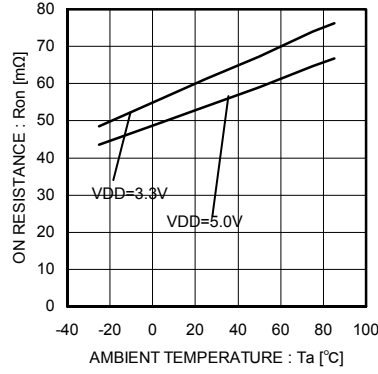

Fig.27 ON resistance

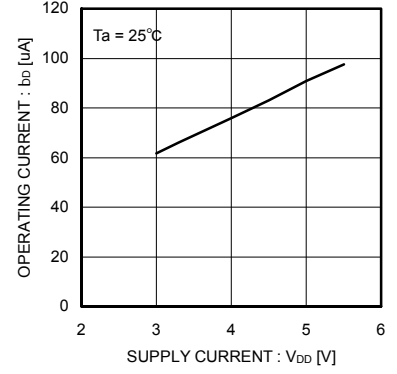

Fig.28 Operating current (CTRL enable)

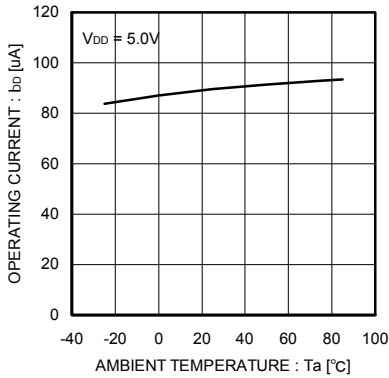

Fig.29 Operating current (CTRL enable)

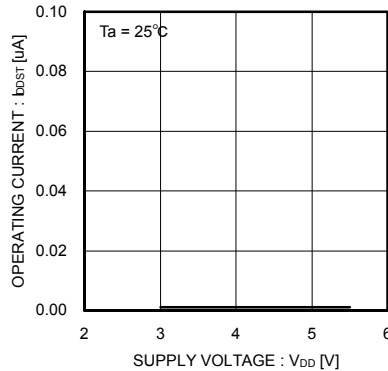

Fig.30 Operating current (CTRL disenable)

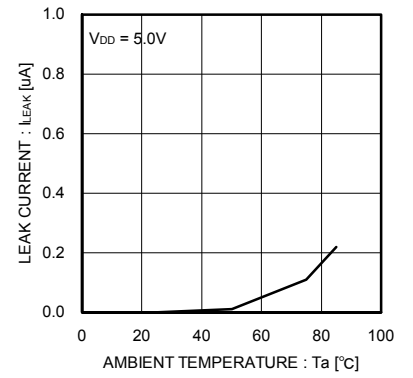

Fig.31 Leak current

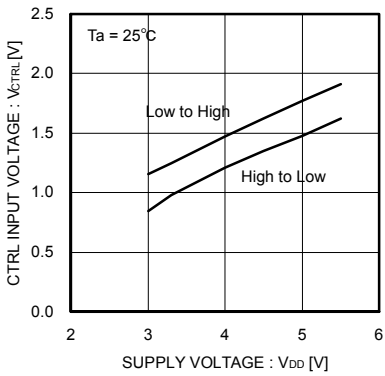

Fig.32 CTRL input voltage

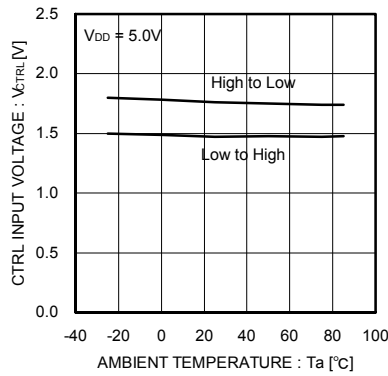

Fig.33 CTRL input voltage

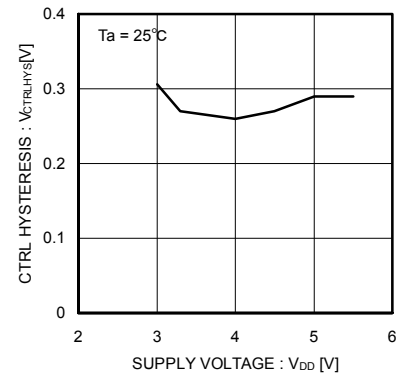

Fig.34 CTRL hysteresis voltage

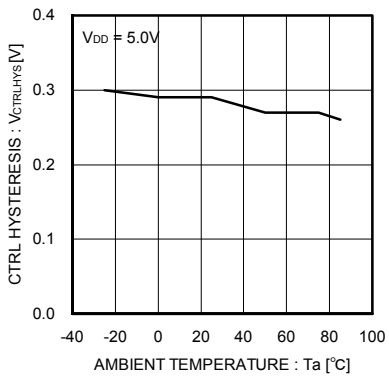

Fig.35 CTRL hysteresis voltage

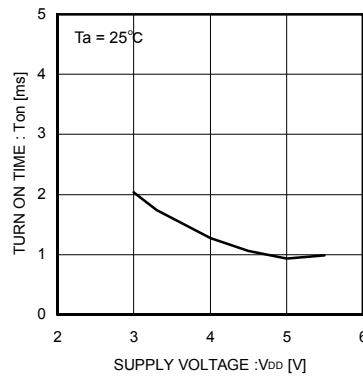

Fig.36 Turn On time

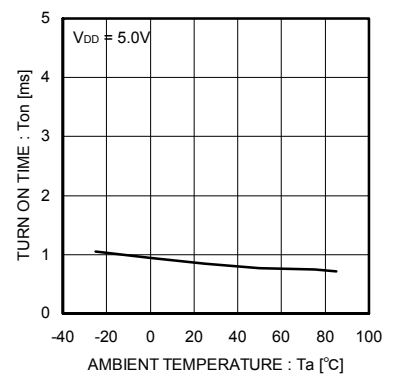

Fig.37 Turn On time

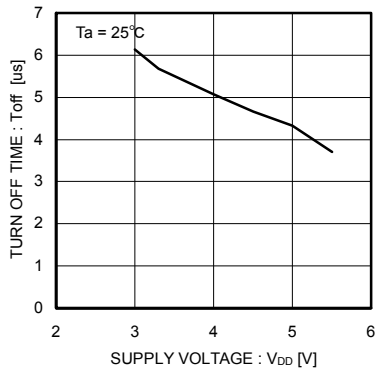

Fig.38 Turn Off time

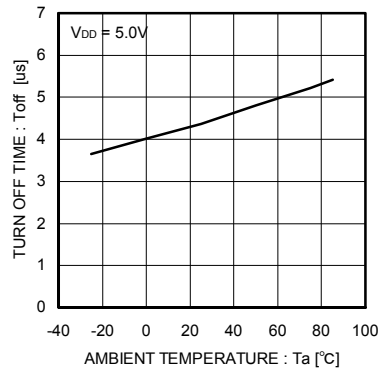

Fig.39 Turn Off time

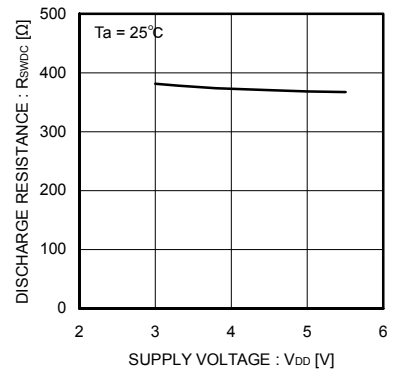

Fig.40 Switch discharge resistance

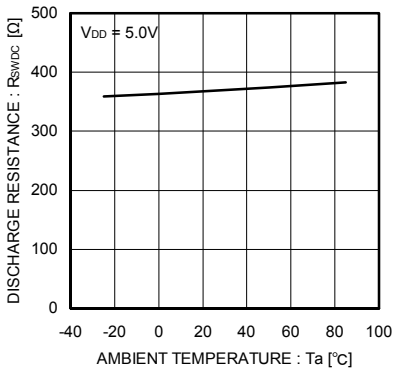

Fig.41 Switch discharge resistance

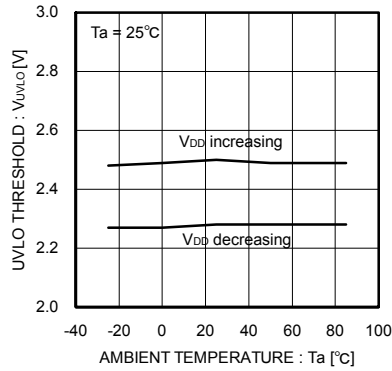

Fig.42 UVLO threshold voltage

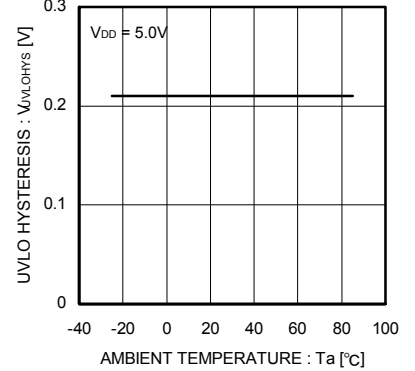

Fig.43 UVLO hysteresis voltage

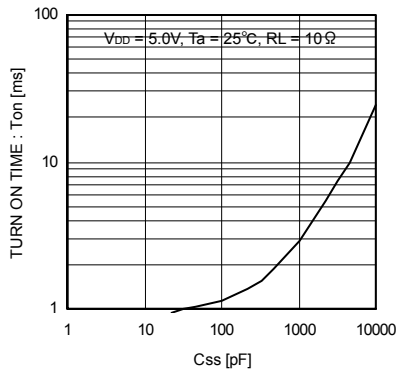

Fig.44 Turn On time (vs. Coss)

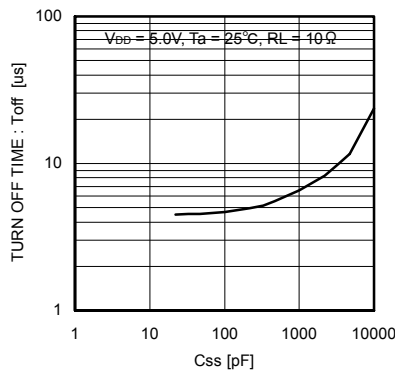

Fig.45 Turn Off time (vs. Coss)

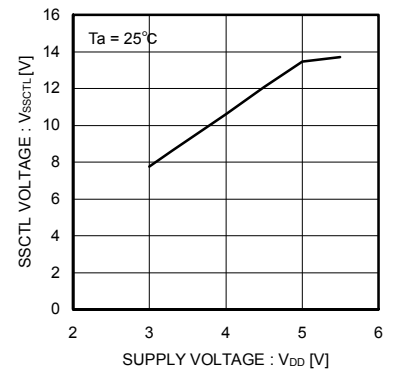

Fig.46 SSCTL output voltage

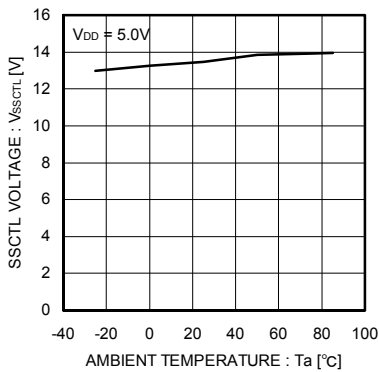

Fig.47 SSCTL output voltage

● Waveform data

$V_{DD} = 5V$, $CL = 47\mu F$, $RL = 47\Omega$, unless otherwise specified.

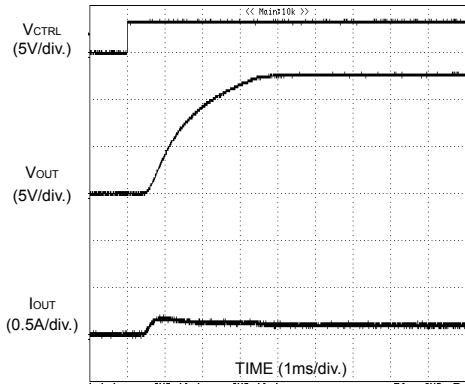

Fig.48 Turn On Rise Time (BD6520F)

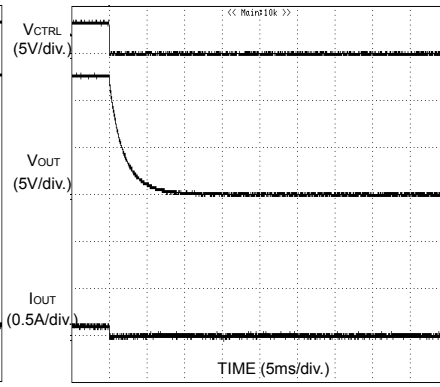

Fig.49 Turn Off Fall Time (BD6520F)

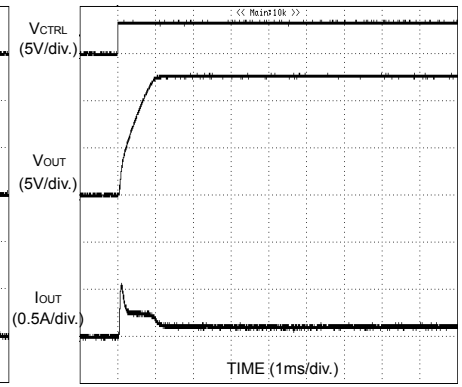

Fig.50 Turn On Rise Time (BD6522F)

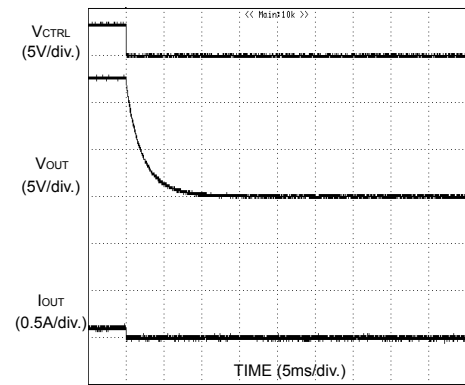

Fig.51 Turn Off Fall Time (BD6522F)

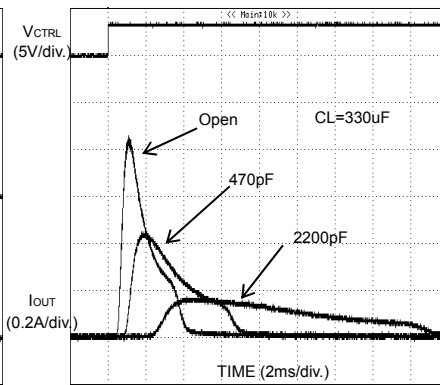

Fig.52 Inrush current vs. Ccss (BD6520F)

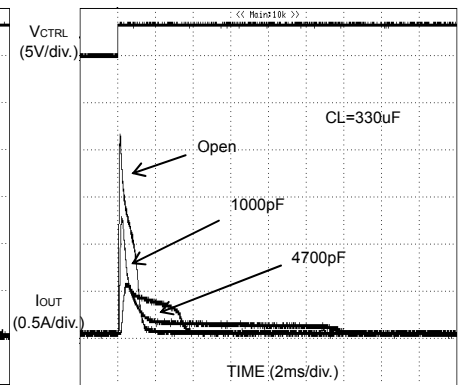

Fig.53 Inrush current vs. Ccss (BD6522F)

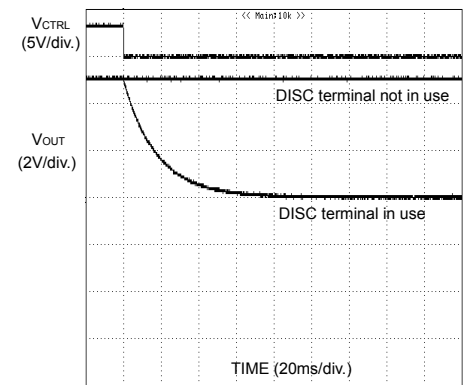

Fig.54 Discharge: $CL = 47\mu F$, $RL = \text{Open}$ (BD6522F)

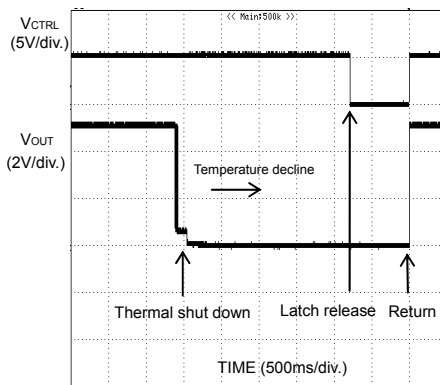

Fig.55 Thermal shutdown

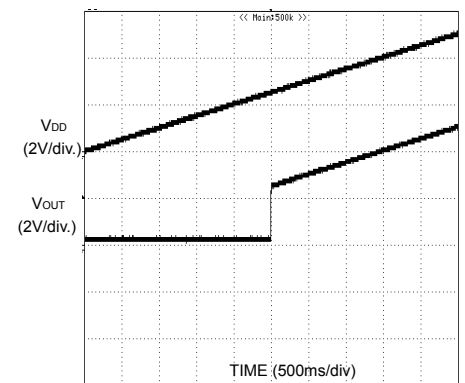

Fig.56 UVLO (at VDD increase)

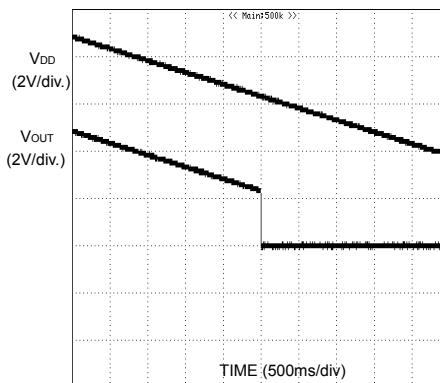

Fig.57 UVLO (at VDD decrease)

●Block diagram, pin configuration, pin description
(BD6520F)

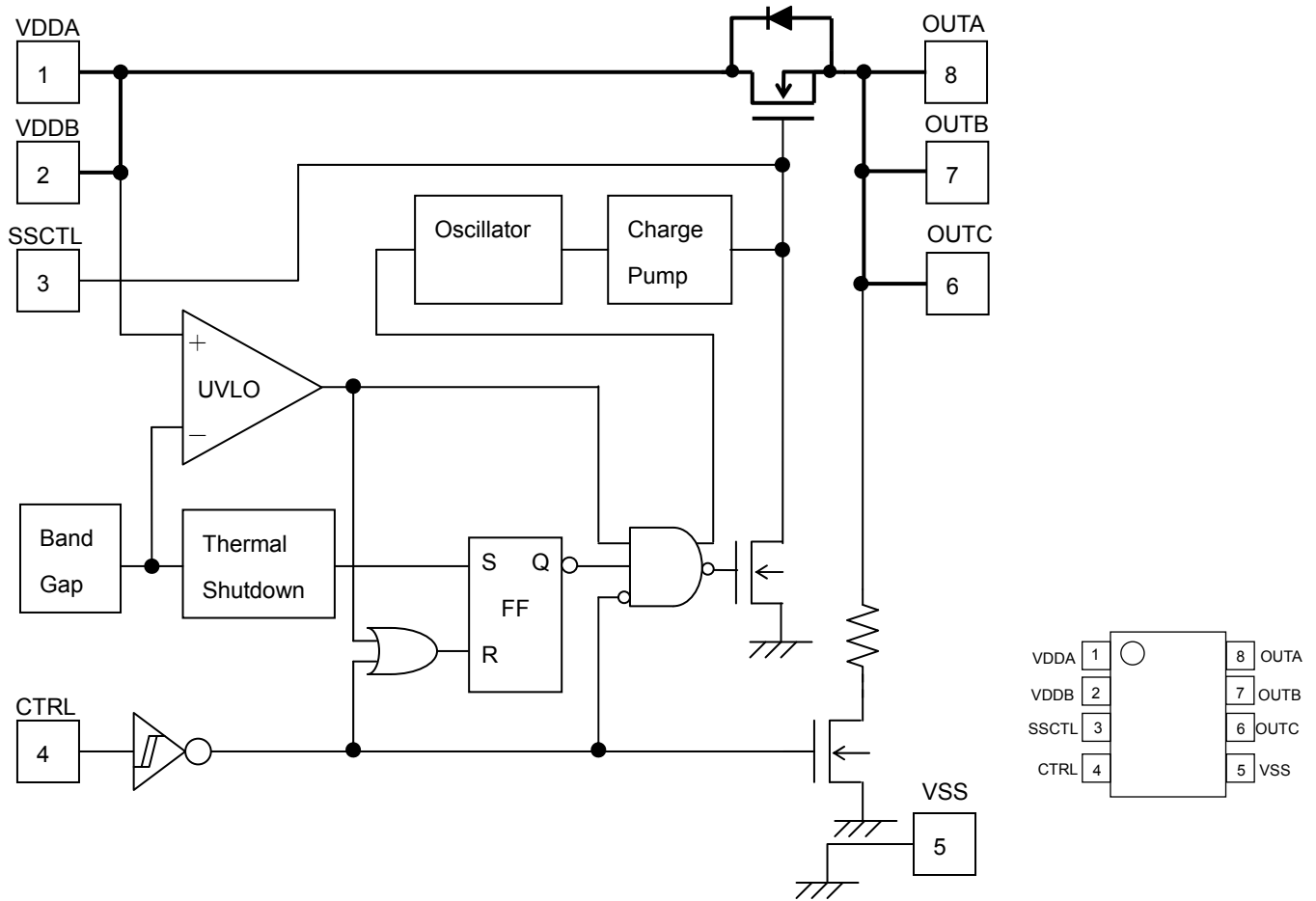

Fig.58 Block diagram(BD6520F)

Pin No.	Symbol	Pin Function
1,2	VDDA, VDDDB	Switch input pin At use, connect each pin outside.
3	SSCTL	Soft start setting pin Add external capacitor, it is possible to delay switch On, Off time.
4	CTRL	Control input pin Switch On at High level, switch Off at Low level.
5	VSS	Ground
6,7,8	OUTA, OUTB, OUTC	Switch output pin At use, connect each pin outside.

(BD6522F)

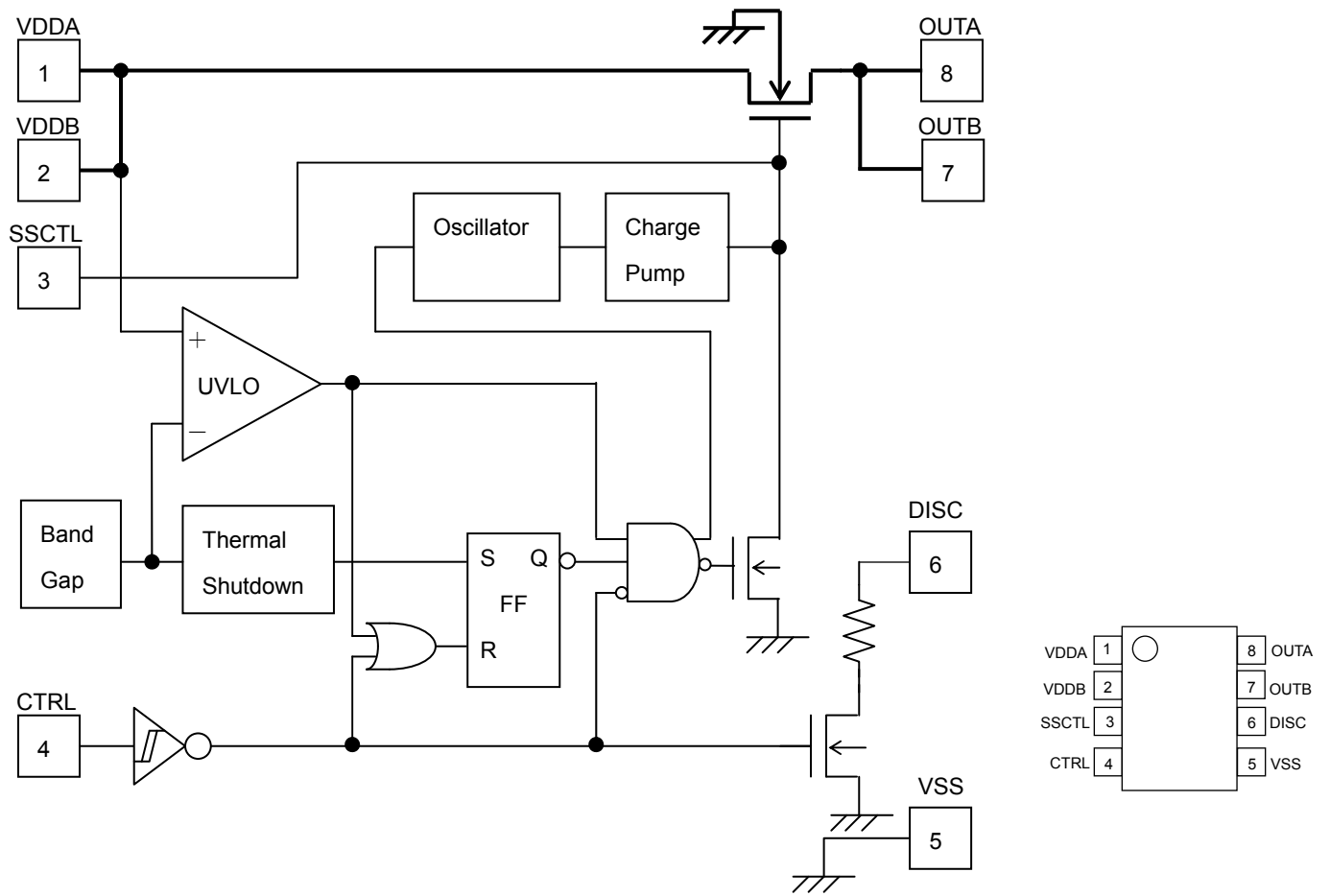

Fig.59 Block diagram(BD6522F)

Pin No.	Symbol	Pin Function
1,2	VDDA, VDDDB	Switch input pin At use, connect each pin outside.
3	SSCTL	Soft start setting pin Add external capacitor, it is possible to delay switch On, Off time.
4	CTRL	Control input pin Switch On at High level, switch Off at Low level.
5	VSS	Ground
6	DISC	Discharge pin
7,8	OUTA, OUTB	Switch output pin At use, connect each pin outside.

● I/O circuit

Symbol	Pin No.	Equivalent circuit BD6520F	Equivalent circuit BD6522F
SSCTL	3		
CTRL	4		
DISC	6 (BD6522F)	/	
OUT	6 (BD6520F), 7, 8		

Fig.60 I/O circuit

● Functional description

1. Switch operation

VDD pin and OUT pin are connected to the drain and the source of switch MOSFET respectively. And the VDD is used also as power source input to internal control circuit.

When CTRL input is set to High level and the switch is turned on, VDD and OUT is connected by a 50mΩ switch. In a normal condition, current flows from VDD to OUT. If voltage of OUT is higher than VDD, current flows from OUT to VDD, since the switch is bidirectional.

In BD6520F, there is a parasitic diode between the drain and the source of switch MOSFET. Therefore, even when the switch is off, if the voltage of OUT is higher than that of VDD, current flows from OUT to VDD. In BD6522F, there is not this parasitic diode, it is possible to prevent current from flowing reversely from OUT to VDD.

2. Thermal shutdown

Thermal shut down circuit turns off the switch when the junction temperature exceeds 135°C(Typ.).

The switch off status of the thermal shut down is latched. Therefore, even when the junction temperature goes down, switch off is maintained. To release the latch, it is necessary to input a signal to switch off to CTRL terminal or make UVLO status. When the switch on signal is input or UVLO is released, the switch output is recovered.

The thermal shut down circuit works when CTRL signal is active.

3. Low voltage malfunction prevention circuit (UVLO)

The UVLO circuit monitors the voltage of the VDD pin, when the CTRL input is active. UVLO circuit prevents the switch from turning on until the VDD exceeds 2.5V(Typ.). If the VDD drops below 2.3V(Typ.) while the switch turns on, then UVLO shuts off the switch.

4. Soft start control

In BD6520F/22F, soft start is carried out in order to reduce inrush current at switch on. Further, in order to reduce inrush current, soft start control pin (SSCTL) is prepared.

By connecting external capacitor to between SSCTL and GND, it is possible to make smoother the switch rise time. When the switch is enabled, SSCTL outputs voltage of about 13.5V.

SSCTL terminal requires high impedance, so pay attention in packaging it so that there should not be leak current. And when voltage is impressed from the outside to SSCTL terminal, switch on, off cannot be made correctly.

5. Discharge circuit

When the switch between the VDD and the OUT is OFF, the 200Ω(Typ.) discharge switch between OUT and GND turns on. By turning on this switch, electric charge at capacitive load is discharged.

In BD6522F, the input of discharge circuit is separately prepared as DISC pin. When to use the discharge circuit, connect OUT pin and DISC pin outside.

●Timing diagram

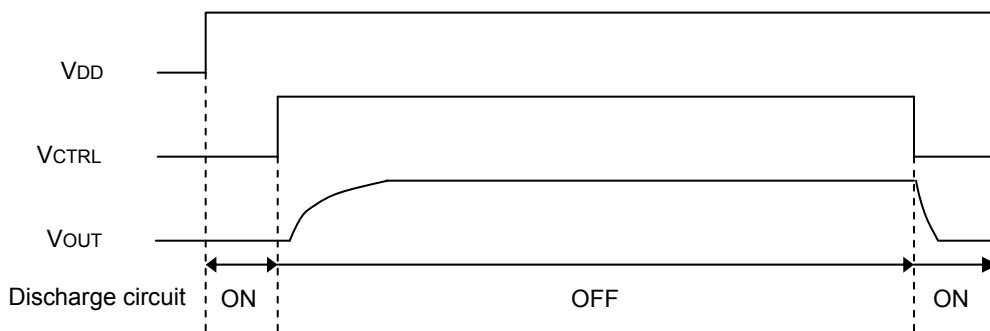

Fig.61 Normal operation

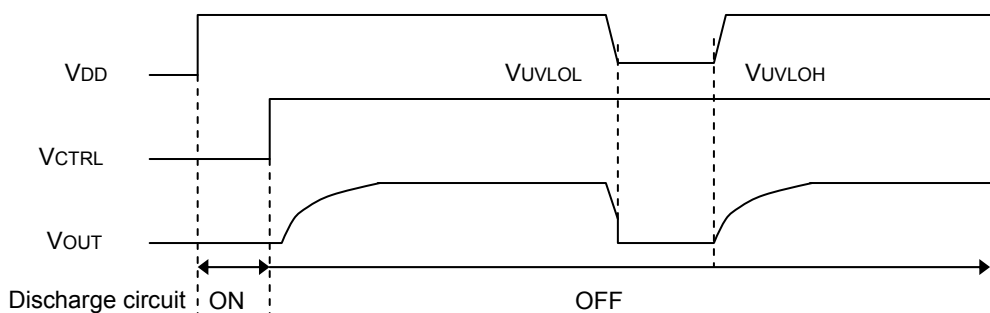

Fig.62 UVLO operation

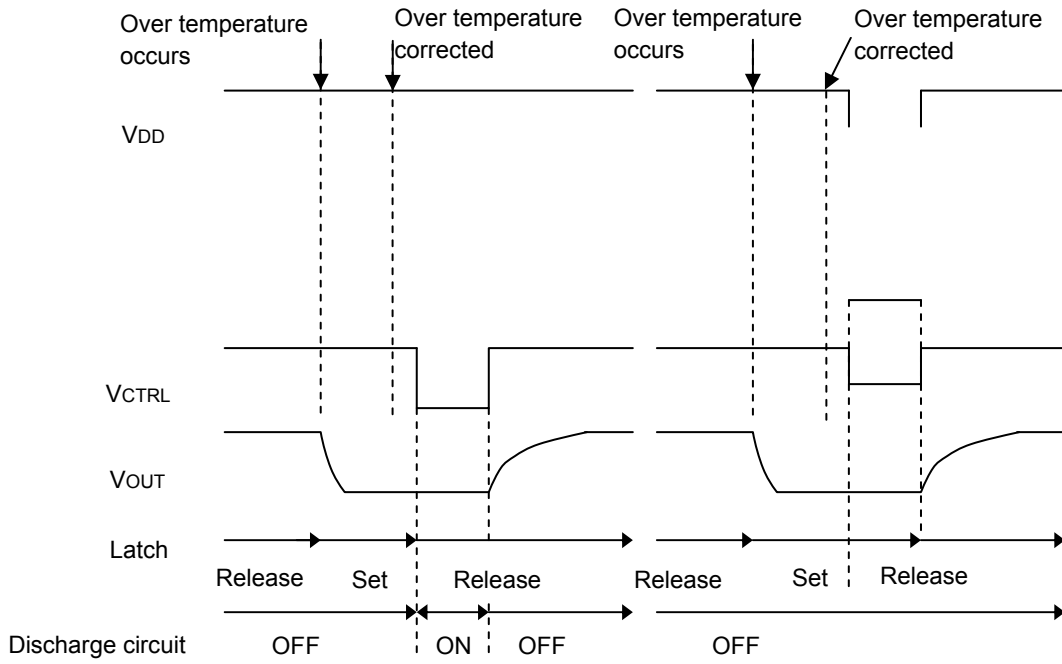

Fig.63 Thermal shutdown operation

● Typical application circuits

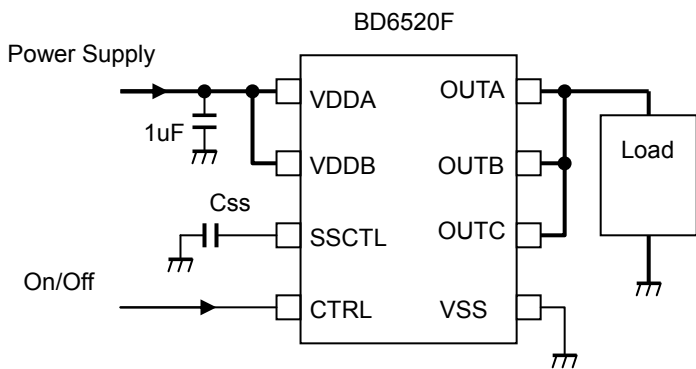

Fig.64 Power supply switch circuit (BD6520F)

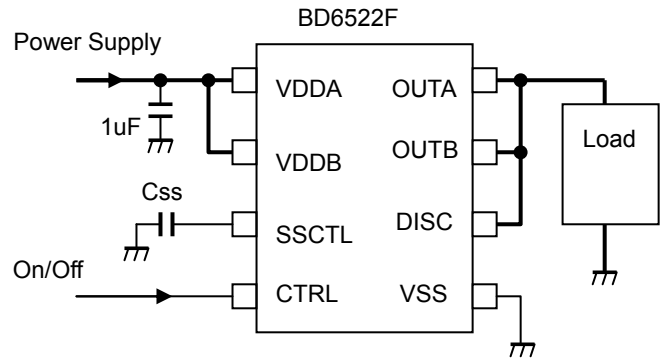

Fig.65 Power supply switch circuit (BD6522F)

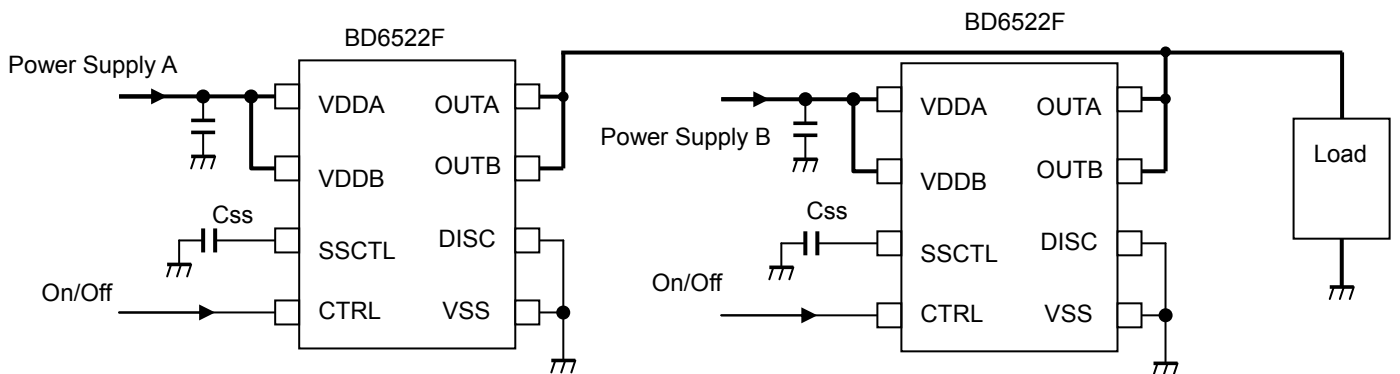

Fig.66 2 power supply changeover switch circuit (BD6522F)

● Thermal derating characteristic

(SOP8)

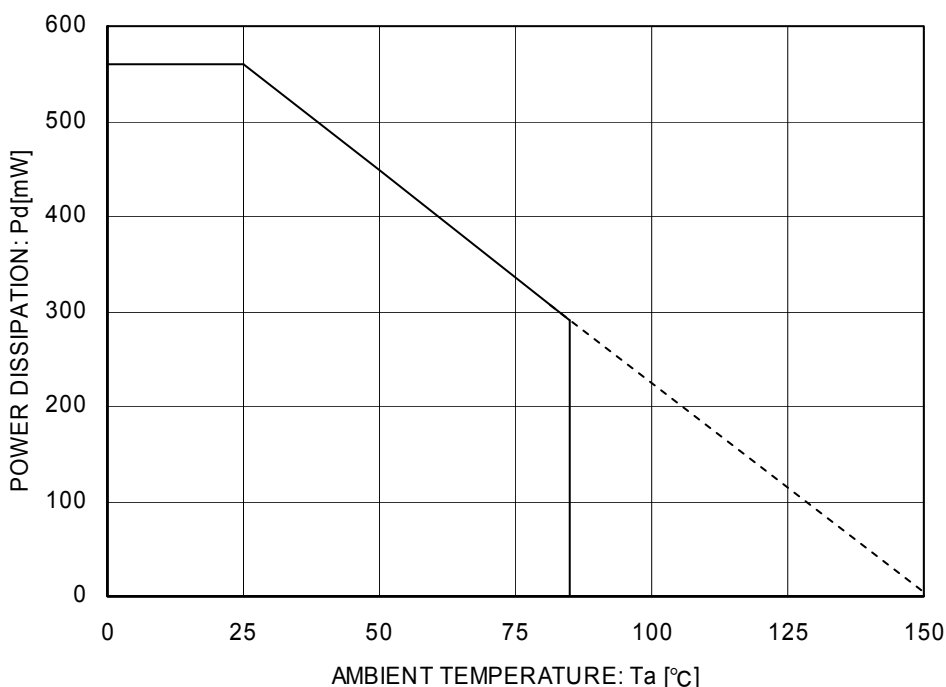

Fig. 67 Power dissipation curve

● Cautions on use

(1) Absolute Maximum Ratings

An excess in the absolute maximum ratings, such as supply voltage, temperature range of operating conditions, etc., can break down devices, thus making impossible to identify breaking mode such as a short circuit or an open circuit. If any special mode exceeding the absolute maximum ratings is assumed, consideration should be given to take physical safety measures including the use of fuses, etc.

(2) Operating conditions

These conditions represent a range within which characteristics can be provided approximately as expected. The electrical characteristics are guaranteed under the conditions of each parameter.

(3) Reverse connection of power supply connector

The reverse connection of power supply connector can break down ICs. Take protective measures against the breakdown due to the reverse connection, such as mounting an external diode between the power supply and the IC's power supply terminal.

(4) Power supply line

Design PCB pattern to provide low impedance for the wiring between the power supply and the GND lines. In this regard, for the digital block power supply and the analog block power supply, even though these power supplies has the same level of potential, separate the power supply pattern for the digital block from that for the analog block, thus suppressing the diffraction of digital noises to the analog block power supply resulting from impedance common to the wiring patterns. For the GND line, give consideration to design the patterns in a similar manner.

Furthermore, for all power supply terminals to ICs, mount a capacitor between the power supply and the GND terminal. At the same time, in order to use an electrolytic capacitor, thoroughly check to be sure the characteristics of the capacitor to be used present no problem including the occurrence of capacity dropout at a low temperature, thus determining the constant.

(5) GND voltage

Make setting of the potential of the GND terminal so that it will be maintained at the minimum in any operating state. Furthermore, check to be sure no terminals are at a potential lower than the GND voltage including an actual electric transient.

(6) Short circuit between terminals and erroneous mounting

In order to mount ICs on a set PCB, pay thorough attention to the direction and offset of the ICs. Erroneous mounting can break down the ICs. Furthermore, if a short circuit occurs due to foreign matters entering between terminals or between the terminal and the power supply or the GND terminal, the ICs can break down.

(7) Operation in strong electromagnetic field

Be noted that using ICs in the strong electromagnetic field can malfunction them.

(8) Inspection with set PCB

On the inspection with the set PCB, if a capacitor is connected to a low-impedance IC terminal, the IC can suffer stress. Therefore, be sure to discharge from the set PCB by each process. Furthermore, in order to mount or dismount the set PCB to/from the jig for the inspection process, be sure to turn OFF the power supply and then mount the set PCB to the jig. After the completion of the inspection, be sure to turn OFF the power supply and then dismount it from the jig. In addition, for protection against static electricity, establish a ground for the assembly process and pay thorough attention to the transportation and the storage of the set PCB.

(9) Input terminals

In terms of the construction of IC, parasitic elements are inevitably formed in relation to potential. The operation of the parasitic element can cause interference with circuit operation, thus resulting in a malfunction and then breakdown of the input terminal. Therefore, pay thorough attention not to handle the input terminals, such as to apply to the input terminals a voltage lower than the GND respectively, so that any parasitic element will operate. Furthermore, do not apply a voltage to the input terminals when no power supply voltage is applied to the IC. In addition, even if the power supply voltage is applied, apply to the input terminals a voltage lower than the power supply voltage or within the guaranteed value of electrical characteristics.

(10) Ground wiring pattern

If small-signal GND and large-current GND are provided, It will be recommended to separate the large-current GND pattern from the small-signal GND pattern and establish a single ground at the reference point of the set PCB so that resistance to the wiring pattern and voltage fluctuations due to a large current will cause no fluctuations in voltages of the small-signal GND. Pay attention not to cause fluctuations in the GND wiring pattern of external parts as well.

(11) External capacitor

In order to use a ceramic capacitor as the external capacitor, determine the constant with consideration given to a degradation in the nominal capacitance due to DC bias and changes in the capacitance due to temperature, etc.

(12) Thermal shutdown circuit (TSD)

When junction temperatures become 135°C (typ.) or higher, the thermal shutdown circuit operates and turns a switch OFF. The thermal shutdown circuit, which is aimed at isolating the LSI from thermal runaway as much as possible, is not aimed at the protection or guarantee of the LSI. Therefore, do not continuously use the LSI with this circuit operating or use the LSI assuming its operation.

(13) Thermal design

Perform thermal design in which there are adequate margins by taking into account the power dissipation (Pd) in actual states of use.

●Product Designation

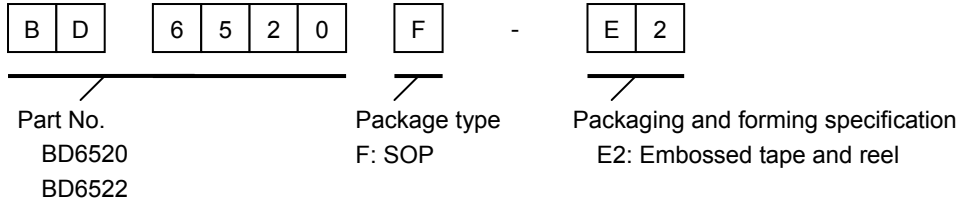

SOP8

<Dimension>

(Unit:mm)

<Tape and Reel information>

Tape	Embossed carrier tape
Quantity	2500pcs
Direction of feed	E2 (The direction is the 1pin of product is at the upper left when you hold reel on the left hand and you pull out the tape on the right hand)

Reel 1Pin Direction of feed →

※When you order , please order in times the amount of package quantity.

- The contents described herein are correct as of May, 2008
- The contents described herein are subject to change without notice. For updates of the latest information, please contact and confirm with ROHM CO.,LTD.
- Any part of this application note must not be duplicated or copied without our permission.
- Application circuit diagrams and circuit constants contained herein are shown as examples of standard use and operation. Please pay careful attention to the peripheral conditions when designing circuits and deciding upon circuit constants in the set.
- Any data, including, but not limited to application circuit diagrams and information, described herein are intended only as illustrations of such devices and not as the specifications for such devices. ROHM CO.,LTD. disclaims any warranty that any use of such devices shall be free from infringement of any third party's intellectual property rights or other proprietary rights, and further, assumes no liability of whatsoever nature in the event of any such infringement, or arising from or connected with or related to the use of such devices.
- Upon the sale of any such devices, other than for buyer's right to use such devices itself, resale or otherwise dispose of the same, implied right or license to practice or commercially exploit any intellectual property rights or other proprietary rights owned or controlled by ROHM CO., LTD. is granted to any such buyer.
- The products described herein utilize silicon as the main material.
- The products described herein are not designed to be X ray proof.

The products listed in this catalog are designed to be used with ordinary electronic equipment or devices (such as audio visual equipment, office-automation equipment, communications devices, electrical appliances and electronic toys). Should you intend to use these products with equipment or devices which require an extremely high level of reliability and the malfunction of which would directly endanger human life (such as medical instruments, transportation equipment, aerospace machinery, nuclear-reactor controllers, fuel controllers and other safety devices), please be sure to consult with our sales representative in advance.

Excellence in Electronics



ROHM CO., LTD.

21, Saiai Mizosaki-cho, Ukyo-ku, Kyoto
615-8585, Japan
TEL: +81-75-311-2121 FAX: +81-75-315-0172
URL: <http://www.rohm.com>

Published by
LSI Business Promotion Dept.

Contact us for further information about the products.

San Diego	TEL: +1-858-625-3630	FAX: +1-858-625-3670	Shanghai	TEL: +86-21-6279-2727	FAX: +86-21-6247-2066
Atlanta	TEL: +1-770-754-5972	FAX: +1-770-754-0691	Hangzhou	TEL: +86-571-87658072	FAX: +86-571-87658071
Boston	TEL: +1-978-371-0382	FAX: +1-928-438-7164	Nanjing	TEL: +86-25-8689-0015	FAX: +86-25-8689-0393
Chicago	TEL: +1-847-368-1006	FAX: +1-847-368-1008	Ningbo	TEL: +86-574-87654201	FAX: +86-574-87654208
Dallas	TEL: +1-469-287-5366	FAX: +1-469-362-7973	Qingdao	TEL: +86-532-5779-312	FAX: +86-532-5779-653
Denver	TEL: +1-303-708-0908	FAX: +1-303-708-0858	Suzhou	TEL: +86-512-6807-1300	FAX: +86-512-6807-2300
Detroit	TEL: +1-248-348-9920	FAX: +1-248-348-9942	Wuxi	TEL: +86-510-82702693	FAX: +86-510-82702992
Nashville	TEL: +1-615-620-6700	FAX: +1-615-620-6702	Shenzhen	TEL: +86-755-8307-3008	FAX: +86-755-8307-3003
Mexico	TEL: +52-33-3123-2001	FAX: +52-33-3123-2002	Dongguan	TEL: +86-769-8393-3320	FAX: +86-769-8398-4140
Duesseldorf	TEL: +49-2154-9210	FAX: +49-2154-921400	Fuzhou	TEL: +86-591-8801-8698	FAX: +86-591-8801-8690
Munich	TEL: +49-8161-48310	FAX: +49-8161-483120	Guangzhou	TEL: +86-20-8364-9796	FAX: +86-20-8364-9707
Stuttgart	TEL: +49-711-72723710	FAX: +49-711-72723720	Huizhou	TEL: +86-752-205-1054	FAX: +86-752-205-1059
France	TEL: +33-1-5697-3060	FAX: +33-1-5697-3080	Xiamen	TEL: +86-592-238-5705	FAX: +86-592-239-8380
United Kingdom	TEL: +44-1-908-306700	FAX: +44-1-908-235788	Zhuhai	TEL: +86-756-3232-480	FAX: +86-756-3232-460
Denmark	TEL: +45-3694-4739	FAX: +45-3694-4789	Hong Kong	TEL: +852-2-740-6262	FAX: +852-2-375-8971
Barcelona	TEL: +34-9375-24320	FAX: +34-9375-24410	Taipei	TEL: +886-2-2500-6956	FAX: +886-2-2503-2869
Hungary	TEL: +36-1-4719338	FAX: +36-1-4719339	Kaohsiung	TEL: +886-7-237-0881	FAX: +886-7-238-7332
Poland	TEL: +48-22-5757213	FAX: +48-22-5757201	Singapore	TEL: +65-6332-2322	FAX: +65-6332-5662
Russia	TEL: +7-95-980-6755	FAX: +7-95-937-8290	Philippines	TEL: +66-2-254-4890	FAX: +66-2-256-6334
Seoul	TEL: +82-2-8182-700	FAX: +82-2-8182-715	Thailand	TEL: +66-3-7958-8355	FAX: +66-3-7958-8377
Masan	TEL: +82-55-240-6234	FAX: +82-55-240-6236	Kuala Lumpur	TEL: +60-3-7958-8355	FAX: +60-3-7958-8377
Dalian	TEL: +86-411-8230-8549	FAX: +86-411-8230-8537	Penang	TEL: +60-4-2286453	FAX: +60-4-2286452
Beijing	TEL: +86-10-8525-2483	FAX: +86-10-8525-2489	Kyoto	TEL: +81-75-365-1218	FAX: +81-75-365-1228
Tianjin	TEL: +86-22-23029181	FAX: +86-22-23029183	Yokohama	TEL: +81-45-476-2290	FAX: +81-45-476-2295

Notes

- No technical content pages of this document may be reproduced in any form or transmitted by any means without prior permission of ROHM CO.,LTD.
- The contents described herein are subject to change without notice. The specifications for the product described in this document are for reference only. Upon actual use, therefore, please request that specifications to be separately delivered.
- Application circuit diagrams and circuit constants contained herein are shown as examples of standard use and operation. Please pay careful attention to the peripheral conditions when designing circuits and deciding upon circuit constants in the set.
- Any data, including, but not limited to application circuit diagrams information, described herein are intended only as illustrations of such devices and not as the specifications for such devices. ROHM CO.,LTD. disclaims any warranty that any use of such devices shall be free from infringement of any third party's intellectual property rights or other proprietary rights, and further, assumes no liability of whatsoever nature in the event of any such infringement, or arising from or connected with or related to the use of such devices.
- Upon the sale of any such devices, other than for buyer's right to use such devices itself, resell or otherwise dispose of the same, no express or implied right or license to practice or commercially exploit any intellectual property rights or other proprietary rights owned or controlled by
- ROHM CO., LTD. is granted to any such buyer.
- Products listed in this document are no antiradiation design.

The products listed in this document are designed to be used with ordinary electronic equipment or devices (such as audio visual equipment, office-automation equipment, communications devices, electrical appliances and electronic toys).

Should you intend to use these products with equipment or devices which require an extremely high level of reliability and the malfunction of which would directly endanger human life (such as medical instruments, transportation equipment, aerospace machinery, nuclear-reactor controllers, fuel controllers and other safety devices), please be sure to consult with our sales representative in advance.

It is our top priority to supply products with the utmost quality and reliability. However, there is always a chance of failure due to unexpected factors. Therefore, please take into account the derating characteristics and allow for sufficient safety features, such as extra margin, anti-flammability, and fail-safe measures when designing in order to prevent possible accidents that may result in bodily harm or fire caused by component failure. ROHM cannot be held responsible for any damages arising from the use of the products under conditions out of the range of the specifications or due to non-compliance with the NOTES specified in this catalog.

Thank you for your accessing to ROHM product informations.

More detail product informations and catalogs are available, please contact your nearest sales office.

ROHM Customer Support System

THE AMERICAS / EUROPE / ASIA / JAPAN

www.rohm.com

Contact us : webmaster@rohm.co.jp