



cDAQ-SL4201

CompactDAQ Strain and Load Measurement Bundle

Datasheet and Specifications

cDAQ-9174 and NI-9237

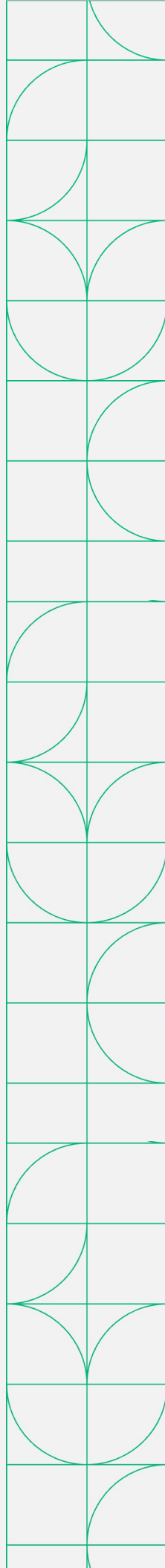

CompactDAQ Strain and Load Measurement Bundle

In-Box Components

cDAQ-SL4201 System P/N: 868019-01



cDAQ-9174
(4-slot CompactDAQ Chassis
w/ Desktop Mounting)



NI-9237 (x2)
(Strain Bridge Input
Module)

Included Accessories:

- Connector Accessories (NI-9949 and NI-9945)
- RJ50 Cables
- USB A to B Cable
- Desktop Mounting Kit
- AC/DC Power Supply*

*IEC Power Cord sold separately based on geographic region

Recommended Software

FlexLogger

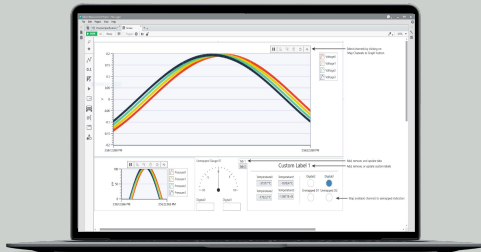

P/N: 785748-3501

No code software that accelerates measurement configuration and logging with NI DAQ Hardware.

- Acquire data and log test results to .tdms or .csv files
- Inline calculations for simple math, filtering, Boolean logic, and more
- Integrated TDMS Viewer for interactive data review

Table of Contents

This document combines the PDFs of this system together. The page numbers in the table of contents correspond to the page number of PDF the component's documentation begins.

cDAQ-9174 Specifications.....	3
NI-9237 Specifications.....	14

cDAQ-9174

Specifications



SPECIFICATIONS

NI cDAQ™ -9174

NI CompactDAQ Four-Slot USB Chassis

These specifications are for the National Instruments CompactDAQ 9174 chassis only. These specifications are typical at 25 °C unless otherwise noted. For the C Series I/O module specifications, refer to the documentation for the C Series I/O module you are using.

Analog Input

Input FIFO size.....	127 samples per slot
Maximum sample rate ¹	Determined by the C Series I/O module or modules
Timing accuracy ²	50 ppm of sample rate
Timing resolution ³	12.5 ns
Number of channels supported.....	Determined by the C Series I/O module or modules

Analog Output

Number of channels supported	
Hardware-timed task	
Onboard regeneration.....	16
Non-regeneration.....	Determined by the C Series I/O module or modules

¹ Performance dependent on type of installed C Series I/O module and number of channels in the task.

² Does not include group delay. For more information, refer to the documentation for each C Series I/O module.

³ Does not include group delay. For more information, refer to the documentation for each C Series I/O module.

Non-hardware-timed task.....	Determined by the C Series I/O module or modules
Maximum update rate	
Onboard regeneration.....	1.6 MS/s (multi-channel, aggregate)
Non-regeneration.....	Determined by the C Series I/O module or modules
Timing accuracy.....	50 ppm of sample rate
Timing resolution.....	12.5 ns
Output FIFO size	
Onboard regeneration.....	8,191 samples shared among channels used
Non-regeneration.....	127 samples per slot
AO waveform modes.....	Non-periodic waveform, periodic waveform regeneration mode from onboard memory, periodic waveform regeneration from host buffer including dynamic update

Digital Waveform Characteristics

Waveform acquisition (DI) FIFO.....	127 samples per slot
Waveform generation (DO) FIFO.....	2,047 samples
Digital input sample clock frequency	
Streaming to application.....	System-dependent memory
Finite.....	0 to 10 MHz
Digital output sample clock frequency	
Streaming from application.....	System-dependent memory
Regeneration from FIFO.....	0 to 10 MHz
Finite.....	0 to 10 MHz
Timing accuracy.....	50 ppm

General-Purpose Counters/Timers

Number of counters/timers.....	4
Resolution.....	32 bits
Counter measurements.....	Edge counting, pulse, semi-period, period, two-edge separation, pulse width
Position measurements.....	X1, X2, X4 quadrature encoding with Channel Z reloading; two-pulse encoding
Output applications.....	Pulse, pulse train with dynamic updates, frequency division, equivalent time sampling
Internal base clocks.....	80 MHz, 20 MHz, 100 kHz
External base clock frequency.....	0 to 20 MHz
Base clock accuracy.....	50 ppm
Output frequency.....	0 to 20 MHz
Inputs.....	Gate, Source, HW_Arm, Aux, A, B, Z, Up_Down
Routing options for inputs.....	Any module PFI, analog trigger, many internal signals
FIFO.....	Dedicated 127-sample FIFO

Frequency Generator

Number of channels.....	1
Base clocks.....	20 MHz, 10 MHz, 100 kHz
Divisors.....	1 to 16 (integers)
Base clock accuracy.....	50 ppm
Output.....	Any module PFI terminal

Module PFI Characteristics

Functionality.....	Static digital input, static digital output, timing input, and timing output
Timing output sources ⁴	Many analog input, analog output, counter, digital input, and digital output timing signals
Timing input frequency.....	0 to 20 MHz
Timing output frequency.....	0 to 20 MHz

Digital Triggers

Source.....	Any module PFI terminal
Polarity.....	Software-selectable for most signals
Analog input function.....	Start Trigger, Reference Trigger, Pause Trigger, Sample Clock, Sample Clock Timebase
Analog output function.....	Start Trigger, Pause Trigger, Sample Clock, Sample Clock Timebase
Counter/timer function.....	Gate, Source, HW_Arm, Aux, A, B, Z, Up_Down

Module I/O States

At power-on.....	Module-dependent. Refer to the documentation for each C Series I/O module.
------------------	--



Note The chassis may revert the input/output of the modules to their power-on state when the USB cable is removed.

⁴ Actual signals available dependent on type of installed C Series I/O module.

Power Requirements



Caution You must use a National Electric Code (NEC) Class 2 power source with the NI cDAQ-9174 chassis.



Note Some C Series I/O modules have additional power requirements. For more information about C Series I/O module power requirements, refer to the documentation for each C Series I/O module.



Note Sleep mode for C Series I/O modules is not supported in the NI cDAQ-9174.

Input voltage range.....	9 to 30 V
Maximum required input power ⁵	15 W
Power input connector.....	2 positions 3.5 mm pitch pluggable screw terminal with screw locks similar to Sauro CTMH020F8-0N001
Power input mating connector.....	Sauro CTF020V8, Phoenix Contact 1714977, or equivalent
Power consumption from USB,.....	500 μ A maximum 4.10 to 5.25 V

Bus Interface

USB specification.....	USB 2.0 Hi-Speed
High-performance data streams.....	7
Data stream types available.....	Analog input, analog output, digital input, digital output, counter/timer input, counter/timer output, NI-XNET ⁶



Note If you are connecting the NI cDAQ-9174 chassis to a USB hub, the hub must be externally powered.

⁵ Includes maximum 1 W module load per slot across rated temperature and product variations.

⁶ When a session is active, CAN or LIN (NI-XNET) C Series modules use a total of two data streams regardless of the number of NI-XNET modules in the chassis.

Physical Characteristics

Weight (unloaded).....Approx. 574 g (20.2 oz)

Dimensions (unloaded).....159.5 mm × 88.1 mm × 58.9 mm
(6.28 in. × 3.47 in. × 2.3 in.) Refer to the following figure.

If you need to clean the chassis, wipe it with a dry towel.

Figure 1. NI cDAQ-9174 Dimensions

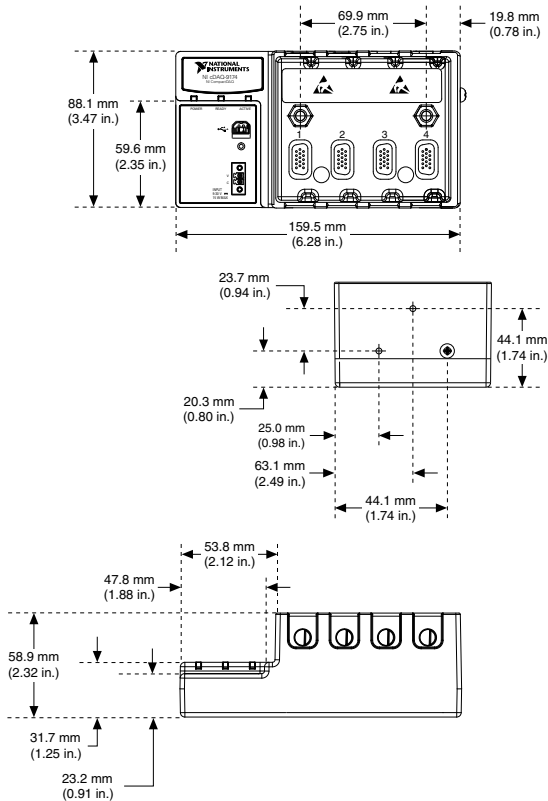

Environmental

Operating temperature ⁷	-20 °C to 55 °C (IEC-60068-2-1 and IEC-60068-2-2)
Storage temperature.....	-40 °C to 85 °C (IEC-600068-2-1 and IEC-60068-2-2)
Ingress protection.....	IP 30
Operating humidity.....	10 to 90% RH, noncondensing (IEC-60068-2-56)
Storage humidity.....	5 to 95% RH, noncondensing (IEC-60068-2-56)
Pollution Degree (IEC 60664).....	2
Maximum altitude.....	5,000 m
Indoor use only.	

Shock and Vibration

To meet these specifications, you must panel mount the NI cDAQ-9174 system, use an NI locking USB cable, and affix ferrules to the ends of the terminal lines.

Operational shock.....	30 g peak, half-sine, 11 ms pulse (Tested in accordance with IEC 60068-2-27. Test profile developed in accordance with MIL-PRF-28800F.)
Random vibration	
Operating.....	5 to 500 Hz, 0.3 g _{rms}
Non-operating.....	5 to 500 Hz, 2.4 g _{rms} (Tested in accordance with IEC 60068-2-64. Non-operating test profile exceeds the requirements of MIL PRF-28800F, Class 3.)

⁷ When operating the NI cDAQ-9174 in temperatures below 0 °C, you must use the PS-15 power supply or another power supply rated for below 0 °C.

Safety

This product meets the requirements of the following standards of safety for electrical equipment for measurement, control, and laboratory use:

- IEC 61010-1, EN 61010-1
- UL 61010-1, CSA 61010-1



Note For UL and other safety certifications, refer to the product label or the *Online Product Certification* section.

Electromagnetic Compatibility

This product meets the requirements of the following EMC standards for electrical equipment for measurement, control, and laboratory use:

- EN 61326-1 (IEC 61326-1): Class A emissions; Basic immunity
- EN 55011 (CISPR 11): Group 1, Class A emissions
- AS/NZS CISPR 11: Group 1, Class A emissions
- FCC 47 CFR Part 15B: Class A emissions
- ICES-001: Class A emissions



Note In the United States (per FCC 47 CFR), Class A equipment is intended for use in commercial, light-industrial, and heavy-industrial locations. In Europe, Canada, Australia, and New Zealand (per CISPR 11) Class A equipment is intended for use only in heavy-industrial locations.



Note Group 1 equipment (per CISPR 11) is any industrial, scientific, or medical equipment that does not intentionally generate radio frequency energy for the treatment of material or inspection/analysis purposes.



Note For EMC declarations and certifications, refer to the *Online Product Certification* section.

CE Compliance

This product meets the essential requirements of applicable European Directives as follows:

- 2006/95/EC; Low-Voltage Directive (safety)
- 2004/108/EC; Electromagnetic Compatibility Directive (EMC)

Online Product Certification

To obtain product certifications and the DoC for this product, visit ni.com/certification, search by model number or product line, and click the appropriate link in the Certification column.

Environmental Management

NI is committed to designing and manufacturing products in an environmentally responsible manner. NI recognizes that eliminating certain hazardous substances from our products is beneficial not only to the environment but also to NI customers.

For additional environmental information, refer to the *Minimize Our Environmental Impact* web page at ni.com/environment. This page contains the environmental regulations and directives with which NI complies, as well as other environmental information not included in this document.

Waste Electrical and Electronic Equipment (WEEE)



EU Customers At the end of the product life cycle, all products must be sent to a WEEE recycling center. For more information about WEEE recycling centers, National Instruments WEEE initiatives, and compliance with WEEE Directive 2002/96/EC on Waste Electrical and Electronic Equipment, visit ni.com/environment/weee.

电子信息产品污染控制管理办法（中国 RoHS）



中国客户 National Instruments 符合中国电子信息产品中限制使用某些有害物质指令 (RoHS)。关于 National Instruments 中国 RoHS 合规性信息，请登录 ni.com/environment/rohs_china。(For information about China RoHS compliance, go to ni.com/environment/rohs_china.)

Refer to the *NI Trademarks and Logo Guidelines* at ni.com/trademarks for information on National Instruments trademarks. Other product and company names mentioned herein are trademarks or trade names of their respective companies. For patents covering National Instruments products/technology, refer to the appropriate location: **Help»Patents** in your software, the `patents.txt` file on your media, or the *National Instruments Patent Notice* at ni.com/patents. You can find information about end-user license agreements (EULAs) and third-party legal notices in the readme file for your NI product. Refer to the *Export Compliance Information* at ni.com/legal/export-compliance for the National Instruments global trade compliance policy and how to obtain relevant HTS codes, ECCNs, and other import/export data.

© 2013 National Instruments. All rights reserved.

374045A-01 May13

NI-9234

DataSheet



DATASHEET

NI 9237

4 AI, ± 25 mV/V, 24 Bit, 50 kS/s/ch Simultaneous, Bridge Completion



- 4 channels, 50 kS/s per channel simultaneous AI
- ± 25 mV/V input range, 24-bit resolution
- Programmable half- and full-bridge completion with up to 10 V internal excitation
- 60 VDC, Category I bank isolation
- RJ50 or D-SUB connectivity options
- -40 °C to 70 °C operating range, 5 g vibration, 50 g shock

The NI 9237 simultaneous bridge module for use with CompactDAQ and CompactRIO contains all the signal conditioning required to power and measure up to four bridge-based sensors simultaneously. The four RJ50 jacks provide direct connectivity to most torque or load cells and offer custom cable solutions with minimal tools. The high sampling rate and bandwidth of the NI 9237 offer a high-quality, high-speed strain or load measurement system with zero interchannel phase delay. With 60 VDC isolation and 1,000 Vrms transient isolation, the NI 9237 has high-common-mode noise rejection and increased safety for both the operator and test system.

The NI 9237 can perform offset/null as well as shunt calibration and remote sense, making the module the best choice for strain and bridge measurements.

The NI 9944 and NI 9945 are accessories for use with quarter-bridge sensors. These accessories have a female RJ50 connector on one end and screw terminals on the other end.

C SERIES SIMULTANEOUS BRIDGE MODULE COMPARISON

Model	Channels	Sample Rate	Resolution	Connectivity	Simultaneous Supported Bridges
NI 9218	2	51.2 kS/s/ch	24 bits	LEMO, 9-pin DSUB	Quarter, Half, Full
NI 9219	4	100 S/s/ch	24 bits	Spring Terminal	Quarter, Half, Full
NI 9235	8	10 kS/s/ch	24 bits	Spring Terminal	120 Ω Quarter Bridge
NI 9236	8	10 kS/s/ch	24 bits	Spring Terminal	350 Ω Quarter Bridge
NI 9237	4	50 kS/s/ch	24 bits	RJ-50, DSUB	Quarter, Half, Full

NI C Series Overview



NI provides more than 100 C Series modules for measurement, control, and communication applications. C Series modules can connect to any sensor or bus and allow for high-accuracy measurements that meet the demands of advanced data acquisition and control applications.

- Measurement-specific signal conditioning that connects to an array of sensors and signals
- Isolation options such as bank-to-bank, channel-to-channel, and channel-to-earth ground
- -40 °C to 70 °C temperature range to meet a variety of application and environmental needs
- Hot-swappable

The majority of C Series modules are supported in both CompactRIO and CompactDAQ platforms and you can move modules from one platform to the other with no modification.

CompactRIO



CompactRIO combines an open-embedded architecture with small size, extreme ruggedness, and C Series modules in a platform powered by the NI LabVIEW reconfigurable I/O (RIO) architecture. Each system contains an FPGA for custom timing, triggering, and processing with a wide array of available modular I/O to meet any embedded application requirement.

CompactDAQ

CompactDAQ is a portable, rugged data acquisition platform that integrates connectivity, data acquisition, and signal conditioning into modular I/O for directly interfacing to any sensor or signal. Using CompactDAQ with LabVIEW, you can easily customize how you acquire, analyze, visualize, and manage your measurement data.



Software

LabVIEW Professional Development System for Windows



- Use advanced software tools for large project development
- Generate code automatically using DAQ Assistant and Instrument I/O Assistant
- Use advanced measurement analysis and digital signal processing
- Take advantage of open connectivity with DLLs, ActiveX, and .NET objects
- Build DLLs, executables, and MSI installers

NI LabVIEW FPGA Module

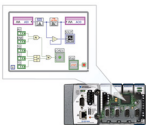

- Design FPGA applications for NI RIO hardware
- Program with the same graphical environment used for desktop and real-time applications
- Execute control algorithms with loop rates up to 300 MHz
- Implement custom timing and triggering logic, digital protocols, and DSP algorithms
- Incorporate existing HDL code and third-party IP including Xilinx IP generator functions
- Purchase as part of the LabVIEW Embedded Control and Monitoring Suite

NI LabVIEW Real-Time Module

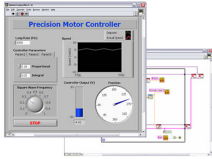

- Design deterministic real-time applications with LabVIEW graphical programming
- Download to dedicated NI or third-party hardware for reliable execution and a wide selection of I/O
- Take advantage of built-in PID control, signal processing, and analysis functions
- Automatically take advantage of multicore CPUs or set processor affinity manually
- Take advantage of real-time OS, development and debugging support, and board support
- Purchase individually or as part of a LabVIEW suite

Circuitry

Each channel on the NI 9237 has an independent 24-bit ADC and an input amplifier that enable you to sample signals from all four channels simultaneously.

The NI 9237 is isolated from earth ground. However, the individual channels are not isolated from each other. The EX+, EX-, and T- signals are common among all channels. You can connect the NI 9237 to a device that is biased at any voltage within the NI 9237 rejection range of earth ground.

Figure 1. Input Circuitry for One Channel of the NI 9237

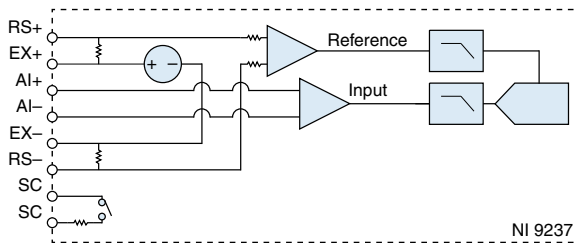

Connection Options to Correct for Resistance Errors

Wiring resistance can create errors in bridge circuits. The NI 9237 provides two mechanisms to correct for these errors: remote sensing and shunt calibration.

Remote Sensing

Remote sensing continuously and automatically corrects for errors in excitation leads, and generally is most appropriate for half- and full-bridge sensors.

Long wire and small gauge wire have greater resistance, which can result in gain error. The resistance in the wires that connect the excitation voltage to the bridge causes a voltage drop,

which is a source of gain error. The NI 9237 includes remote sensing to compensate for this gain error. Connect remote sense wires to the points where the excitation voltage wires connect to the bridge circuit. Refer to the following figure for an illustration of how to connect remote sense wires to the NI 9237.

Figure 2. Connecting Remote Sense Wires to the NI 9237

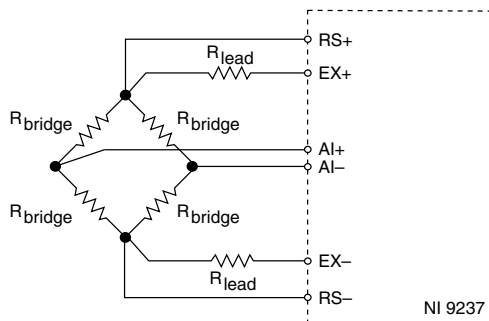

The actual bridge excitation voltage is smaller than the voltage at the EX+ and EX- leads. If you do not use remote sensing of the actual bridge voltage, the resulting gain error is:

$$\frac{R_{lead}}{R_{bridge}} \text{ for half-bridge sensors and}$$

$$\frac{2 \cdot R_{lead}}{R_{bridge}} \text{ for full-bridge sensors.}$$

If you connect the remote sense signals directly to the bridge resistors, the NI 9237 senses the actual bridge voltage and eliminates the gain errors caused by the resistance of the EX+ and EX- leads.

Shunt Calibration

Shunt calibration can correct for errors from the resistance of both the excitation wiring and wiring in the individual resistors of the bridge. Remote sensing corrects for resistances from the EX pins on the NI 9237 to the sensor, and shunt calibration corrects for these errors and for errors caused by wire resistance within an arm of the bridge. Shunt calibration is most useful with quarter-bridge sensors because there may be significant resistance in the wiring to the active resistor in the bridge.

The NI 9237 shunt calibration circuitry consists of a precision resistor and a software-controlled switch. Refer to the software help for information about enabling the shunt calibration switch for the NI 9237.

Shunt calibration involves simulating the input of strain by changing the resistance of an arm in the bridge by some known amount. This is accomplished by shunting, or connecting, a large resistor of known value across one arm of the bridge, creating a known strain-induced change in resistance. You can then measure the output of the bridge and compare it to the expected voltage value. You can use the results to correct gain errors in the entire measurement path, or to simply verify general operation to gain confidence in the setup.

Use a stable signal, which is typically the unloaded state of the sensor, first with the shunt calibration switch off and then again with the switch on. The difference in these two measurements provides an indication of the gain errors from wiring resistances. You can design the software application to correct subsequent readings for this gain error.

Excitation Voltages

You can program the NI 9237 to supply 2.5 V, 3.3 V, 5 V, or 10 V of excitation voltage. The maximum excitation power for internal excitation is 150 mW.



Note Unless you supply external excitation voltage, NI recommends that you set the excitation voltage to a value that keeps the total power below 150 mW. The NI 9237 automatically reduces internal excitation voltages as needed to stay below 150 mW total power.

Use the following equation to calculate the power of a single bridge:

$$P = \frac{V_{ex}^2}{R}$$

where R is the total resistance of the bridge.

For a quarter or half bridge, R is equal to two times the resistance of each element. For a full bridge, R is equal to the resistance of each element.

The 150 mW limit allows you to power half and full bridges as follows:

- Four 350 Ω half bridges at 5.0 V
- Four 350 Ω full bridges at 3.3 V
- Four 120 Ω half bridges at 2.5 V

External Excitation

You can connect an external excitation voltage source to the NI 9237 if you need an excitation voltage that causes more than 150 mW to dissipate across all the bridges.

Figure 3. Connecting an External Excitation Voltage Source to the NI 9237

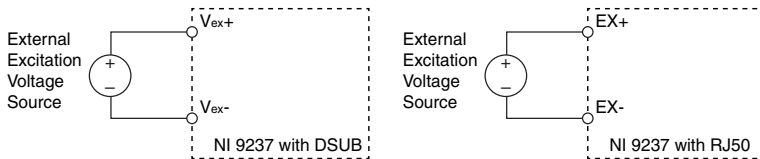

Note For the NI 9237 with RJ-50, use the two EX+ and EX- terminals on the four-terminal external excitation voltage connector to connect one external excitation source.

You can use the additional EX+ and EX- terminals on the connector to wire multiple NI 9237 modules together in a daisy chain.

Filtering

The NI 9237 uses a combination of analog and digital filtering to provide an accurate representation of in-band signals and reject out-of-band signals. The filters discriminate between signals based on the frequency range, or bandwidth, of the signal. The three important bandwidths to consider are the passband, the stopband, and the anti-imaging bandwidth.

The NI 9237 represents signals within the passband, as quantified primarily by passband ripple and phase nonlinearity. All signals that appear in the alias-free bandwidth are either unaliased signals or signals that have been filtered by at least the amount of the stopband rejection.

Passband

The signals within the passband have frequency-dependent gain or attenuation. The small amount of variation in gain with respect to frequency is called the passband flatness. The digital filters of the NI 9237 adjust the frequency range of the passband to match the data rate. Therefore, the amount of gain or attenuation at a given frequency depends on the data rate.

Figure 4. Typical Passband Flatness for the NI 9237

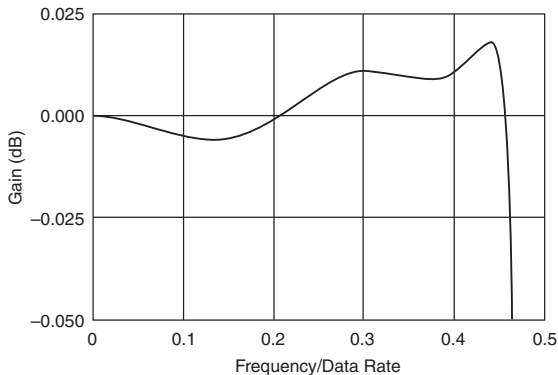

Stopband

The filter significantly attenuates all signals above the stopband frequency. The primary goal of the filter is to prevent aliasing. Therefore, the stopband frequency scales precisely with the data rate. The stopband rejection is the minimum amount of attenuation applied by the filter to all signals with frequencies within the stopband.

Alias-Free Bandwidth

Any signals that appear in the alias-free bandwidth are not aliased artifacts of signals at a higher frequency. The alias-free bandwidth is defined by the ability of the filter to reject frequencies above the stopband frequency. The alias-free bandwidth is equal to the data rate minus the stopband frequency.

Data Rates

The frequency of a master timebase (f_M) controls the data rate (f_s) of the NI 9237. The NI 9237 includes an internal master timebase with a frequency of 12.8 MHz, but the module also can accept an external master timebase or export its own master timebase. To synchronize the data rate of an NI 9237 with other modules that use master timebases to control sampling, all of the modules must share a single master timebase source.

The following equation provides the available data rates of the NI 9237:

$$f_s = \frac{f_M \div 256}{n}$$

where n is any integer from 1 to 31.

However, the data rate must remain within the appropriate data rate range. When using the internal master timebase of 12.8 MHz, the result is data rates of 50 kS/s, 25 kS/s, 16.667 kS/s, and so on down to 1.613 kS/s depending on the value of n . When using an external timebase with a frequency other than 12.8 MHz, the NI 9237 has a different set of data rates.



Note The NI 9151 R Series Expansion chassis does not support sharing timebases between modules.

NI 9237 Specifications

The following specifications are typical for the range -40 °C to 70 °C unless otherwise noted.



Caution Do not operate the NI 9237 in a manner not specified in this document. Product misuse can result in a hazard. You can compromise the safety protection built into the product if the product is damaged in any way. If the product is damaged, return it to NI for repair.

Input Characteristics

Number of channels	4 analog input channels
Bridge completion	
Half and Full	Internal
Quarter	External
ADC resolution	24 bits
Type of ADC	Delta-Sigma (with analog prefiltering)
Sampling mode	Simultaneous

Internal master timebase (f_M)

Frequency	12.8 MHz
Accuracy	±100 ppm maximum
Data rate range (f_s) using internal master timebase	
Minimum	1.613 kS/s
Maximum	50 kS/s
Data rate range (f_s) using external master timebase	
Minimum	391 S/s
Maximum	51.36 kS/s
Data rates (f_s)	$(f_M \div 256) \div n$, where $n = 1, 2, \dots, 31$
Typical input range	±25 mV/V
Scaling coefficient	2.9802 nV/V per LSB
Overvoltage protection between any two pins	±30 V

Table 1. Accuracy

Measurement Conditions ¹		Percent of Reading (Gain Error ²)	Percent of Range ³ (Offset Error)
Calibrated	Typical (25 °C, ±5 °C)	0.05%	0.05%
	Maximum (– 40 to 70 °C)	0.20%	0.25%
Uncalibrated ⁴	Typical (25 °C, ±5 °C)	0.20%	0.10%
	Maximum (– 40 to 70 °C)	0.55%	0.35%

Gain drift	10 ppm/°C maximum
Offset drift	
2.5 V excitation	0.6 μV/V per °C
3.3 V excitation	0.5 μV/V per °C
5 V excitation	0.3 μV/V per °C
10 V excitation	0.2 μV/V per °C

¹ Before offset null or shunt calibration.

² Applies at a data rate of 50 kS/s. Lower data rates can have up to 0.20% of reading additional gain error.

³ Range equals 25 mV/V.

⁴ Uncalibrated accuracy refers to the accuracy achieved when acquiring data in raw or unscaled modes and in which calibration constants that are stored in the module are not applied to the data.

Half-bridge completion

Tolerance	$\pm 1200 \mu\text{V/V}$ maximum
Drift	$1.5 \mu\text{V/V}$ per $^{\circ}\text{C}$

Table 2. Channel-to-Channel Matching (Calibrated)

Input Signal Frequency (f_{in})	Gain		Phase
	Typical	Maximum	Maximum
0 to 1 kHz	0.15%	0.3%	$0.125^{\circ}/\text{kHz} \cdot f_{in}$
1 to 20 kHz	0.4%	1.1%	

Phase nonlinearity

$f_{in} = 0$ to 1 kHz	$< 0.001^{\circ}$
$f_{in} = 0$ to 20 kHz	$\pm 0.1^{\circ}$

Input delay $(40 + 5/512)/f_s + 4.5 \mu\text{s}$

Passband

Frequency	$0.45 \cdot f_s$
Flatness	0.1 dB maximum

Stopband

Frequency	$0.55 \cdot f_s$
Rejection	100 dB

Alias-free bandwidth $0.45 \cdot f_s$

Oversample rate $64 \cdot f_s$

Rejection at oversample rate⁵

$f_s = 10 \text{ kS/s}$	60 dB @ 640 kHz
$f_s = 50 \text{ kS/s}$	90 dB @ 3.2 MHz

Common-mode voltage, all signals to earth ground $\pm 60 \text{ VDC}$

Common-mode voltage range, with respect to EX- $\pm 1 \text{ V}$ from the midpoint of the excitation voltage

⁵ Rejection by analog prefilter of signal frequencies at oversample rate.

CMRR

Relative to earth ground ⁶ ($f_{in} = 0$ to 60 Hz)	140 dB
Relative to EX- ($f_{in} = 0$ to 1 kHz)	85 dB
SFDR (1 kHz, -60 dBFS)	115 dB
Total Harmonic Distortion (THD)	
1 kHz, -20 dBFS	-95 dB
8 kHz, -20 dBFS	-95 dB

Table 3. Input Noise

Excitation Voltage	Density, (nV/ V_{rms} per $\sqrt{1 \text{ Hz}}$	Total, $f_{in} = 0$ to 1 kHz (nV/ V_{rms})	Total, $f_{in} = 0$ to 25 kHz ($\mu\text{V}/V_{rms}$)	
	Full Bridge	Full Bridge	Full Bridge	Half Bridge
2.5 V	8	250	1.3	1.6
3.3 V	6	190	1.0	1.2
5 V	4	130	0.6	0.8
10 V	2	65	0.3	0.5

Excitation noise 100 μV_{rms}

Crosstalk (not including cable effects)

$f_{in} = 1 \text{ kHz}$ 110 dB

$f_{in} = 10 \text{ kHz}$ 100 dB

Excitation

Internal voltage 2.5 V, 3.3 V, 5.0 V, 10.0 V

Internal power 150 mW maximum

External voltage 2 V to 10 V

Shunt calibration

Resistance 100 k Ω

⁶ Measured with a balanced cable on the NI 9237 with RJ-50 and with no cable on the NI 9237 with DSUB. Shielded cables that are not twisted-pair may be significantly unbalanced, which can impact CMRR performance. To improve the balance of shielded cables, NI recommends twisting together the AI+/AI- pair, the RS+/RS- pair, and the EX+/EX- pair.

Resistor accuracy	
25 °C	±110 Ω
– 40 °C to 70 °C	±200 Ω
MTBF	
NI 9237 with RJ-50	603,359 hours at 25 °C; Bellcore Issue 2, Method 1, Case 3, Limited Part Stress Method
NI 9237 with DSUB	704,148 hours at 25 °C; Bellcore Issue 2, Method 1, Case 3, Limited Part Stress Method

Power Requirements

Power consumption from chassis	
Active mode	740 mW maximum
Sleep mode	25 μW maximum
Thermal dissipation (at 70 °C)	
Active mode	740 mW maximum
Sleep mode	25 μW maximum

Physical Characteristics

If you need to clean the module, wipe it with a dry towel.



Tip For two-dimensional drawings and three-dimensional models of the C Series module and connectors, visit ni.com/dimensions and search by module number.

Safety Voltages

Connect only voltages that are within the following limits.

Between any two pins	±30 V maximum
Isolation, channel-to-channel	None
Isolation, channel-to-earth ground	
Up to 3,000 m	
Continuous	60 VDC, Measurement Category I
Withstand	1,000 Vrms, verified by a 5 s dielectric withstand test
Up to 5,000 m	
Continuous	60 VDC, Measurement Category I
Withstand	860 Vrms, verified by a 5 s dielectric withstand test

Measurement Category I is for measurements performed on circuits not directly connected to the electrical distribution system referred to as *MAINS* voltage. MAINS is a hazardous live electrical supply system that powers equipment. This category is for measurements of voltages from specially protected secondary circuits. Such voltage measurements include signal levels, special equipment, limited-energy parts of equipment, circuits powered by regulated low-voltage sources, and electronics.



Caution Do not connect the NI 9237 to signals or use for measurements within Measurement Categories II, III, or IV.



Note Measurement Categories CAT I and CAT O are equivalent. These test and measurement circuits are not intended for direct connection to the MAINS building installations of Measurement Categories CAT II, CAT III, or CAT IV.

Hazardous Locations

U.S. (UL)	Class I, Division 2, Groups A, B, C, D, T4; Class I, Zone 2, AEx nA IIC T4
Canada (C-UL)	Class I, Division 2, Groups A, B, C, D, T4; Class I, Zone 2, Ex nA IIC T4
Europe (ATEX) and International (IECEX)	Ex nA IIC T4 Gc

Safety and Hazardous Locations Standards

This product is designed to meet the requirements of the following electrical equipment safety standards for measurement, control, and laboratory use:

- IEC 61010-1, EN 61010-1
- UL 61010-1, CSA 61010-1
- EN 60079-0:2012, EN 60079-15:2010
- IEC 60079-0: Ed 6, IEC 60079-15; Ed 4
- UL 60079-0; Ed 5, UL 60079-15; Ed 3
- CSA 60079-0:2011, CSA 60079-15:2012



Note For UL and other safety certifications, refer to the product label or the [Online Product Certification](#) section.

Electromagnetic Compatibility

This product meets the requirements of the following EMC standards for sensitive electrical equipment for measurement, control, and laboratory use:

- EN 61326-2-1 (IEC 61326-2-1): Class A emissions; Industrial immunity
- EN 55011 (CISPR 11): Group 1, Class A emissions
- AS/NZS CISPR 11: Group 1, Class A emissions

- FCC 47 CFR Part 15B: Class A emissions
- ICES-001: Class A emissions



Note In the United States (per FCC 47 CFR), Class A equipment is intended for use in commercial, light-industrial, and heavy-industrial locations. In Europe, Canada, Australia and New Zealand (per CISPR 11) Class A equipment is intended for use only in heavy-industrial locations.



Note Group 1 equipment (per CISPR 11) is any industrial, scientific, or medical equipment that does not intentionally generate radio frequency energy for the treatment of material or inspection/analysis purposes.



Note For EMC declarations and certifications, and additional information, refer to the [Online Product Certification](#) section.

CE Compliance

This product meets the essential requirements of applicable European Directives, as follows:

- 2014/35/EU; Low-Voltage Directive (safety)
- 2014/30/EU; Electromagnetic Compatibility Directive (EMC)
- 94/9/EC; Potentially Explosive Atmospheres (ATEX)

Online Product Certification

Refer to the product Declaration of Conformity (DoC) for additional regulatory compliance information. To obtain product certifications and the DoC for this product, visit ni.com/certification, search by model number or product line, and click the appropriate link in the Certification column.

Shock and Vibration

To meet these specifications, you must panel mount the system.

Operating vibration	
Random (IEC 60068-2-64)	5 g _{rms} , 10 Hz to 500 Hz
Sinusoidal (IEC 60068-2-6)	5 g, 10 Hz to 500 Hz
Operating shock (IEC 60068-2-27)	30 g, 11 ms half sine; 50 g, 3 ms half sine; 18 shocks at 6 orientations

Environmental

Refer to the manual for the chassis you are using for more information about meeting these specifications.

Operating temperature (IEC 60068-2-1, IEC 60068-2-2)	-40 °C to 70 °C
Storage temperature (IEC 60068-2-1, IEC 60068-2-2)	-40 °C to 85 °C
Ingress Protection	
NI 9237 with RJ-50	IP30
NI 9237 with DSUB	IP40
Operating humidity (IEC 60068-2-78)	10% RH to 90% RH, noncondensing
Storage humidity (IEC 60068-2-78)	5% RH to 95% RH, noncondensing
Pollution Degree	2
Maximum altitude	5,000 m

Indoor use only.

Environmental Management

NI is committed to designing and manufacturing products in an environmentally responsible manner. NI recognizes that eliminating certain hazardous substances from our products is beneficial to the environment and to NI customers.

For additional environmental information, refer to the *Minimize Our Environmental Impact* web page at ni.com/environment. This page contains the environmental regulations and directives with which NI complies, as well as other environmental information not included in this document.

Waste Electrical and Electronic Equipment (WEEE)



EU Customers At the end of the product life cycle, all NI products must be disposed of according to local laws and regulations. For more information about how to recycle NI products in your region, visit ni.com/environment/weee.

电子信息产品污染控制管理办法（中国 RoHS）



中国客户 National Instruments 符合中国电子信息产品中限制使用某些有害物质指令 (RoHS)。关于 National Instruments 中国 RoHS 合规性信息，请登录 ni.com/environment/rohs_china。(For information about China RoHS compliance, go to ni.com/environment/rohs_china.)

Calibration

You can obtain the calibration certificate and information about calibration services for the NI 9237 at ni.com/calibration.

Calibration interval	1 year
----------------------	--------

Refer to the *NI Trademarks and Logo Guidelines* at ni.com/trademarks for information on NI trademarks. Other product and company names mentioned herein are trademarks or trade names of their respective companies. For patents covering NI products/technology, refer to the appropriate location: **Help»Patents** in your software, the `patents.txt` file on your media, or the *National Instruments Patent Notice* at ni.com/patents. You can find information about end-user license agreements (EULAs) and third-party legal notices in the readme file for your NI product. Refer to the *Export Compliance Information* at ni.com/legal/export-compliance for the NI global trade compliance policy and how to obtain relevant HTS codes, ECCNs, and other import/export data. NI MAKES NO EXPRESS OR IMPLIED WARRANTIES AS TO THE ACCURACY OF THE INFORMATION CONTAINED HEREIN AND SHALL NOT BE LIABLE FOR ANY ERRORS. U.S. Government Customers: The data contained in this manual was developed at private expense and is subject to the applicable limited rights and restricted data rights as set forth in FAR 52.227-14, DFAR 252.227-7014, and DFAR 252.227-7015.

© 2006—2015 National Instruments. All rights reserved.

374186A-02 Nov15