

XCMH2106L1

XCMH Limit Switches Miniature Plastic Cat's whisker NC + NO Snap L1



Main

Range of product	Telemecanique Limit switches XC Standard
Series name	Standard format
Product or component type	Limit switch
Device short name	XCMH
Sensor design	Miniature
Body type	Fixed
Head type	Multi-directional head
Material	Plastic
Body material	Plastic
Head material	Zamak
Fixing mode	By the body
Movement of operating head	Multi-directional
Type of operator	Spring return cat's whisker
Type of approach	Multi-directional approach
Number of poles	2
Contacts type and composition	1 NC + 1 NO
Contact operation	Snap action

Complementary

Switch actuation	By any moving part
Electrical connection	Fixed cable
Cable length	1 m
Cable composition	4 x 0.34 mm ²
Wire insulation material	PvR
Contacts insulation form	Zb
Positive opening	Without
Minimum force for tripping	0.1 N
Maximum actuation speed	1 m/s
Contact code designation	C300, AC-15 (U _e = 240 V), I _e = 0.75 A conforming to EN/IEC 60947-5-1 appendix A R300, DC-13 (U _e = 250 V), I _e = 0.1 A conforming to EN/IEC 60947-5-1 appendix A
[Ui] rated insulation voltage	300 V (pollution degree 3) conforming to UL 508 300 V (pollution degree 3) conforming to IEC 60947-5-1 300 V (pollution degree 3) conforming to CSA C22.2 No 14
Maximum resistance across terminals	25 MOhm conforming to IEC 60255-7 category 3
[Uimp] rated impulse withstand voltage	4 kV conforming to IEC 60664 4 kV conforming to IEC 60947-1
Short-circuit protection	6 A cartridge fuse, type gG
Electrical durability	5000000 Cycles, DC-13, 120 V, 1 W, operating rate <60 cyc/mn, load factor: 0.5 conforming to IEC 60947-5-1 appendix C 5000000 Cycles, DC-13, 24 V, 3 W, operating rate <60 cyc/mn, load factor: 0.5 conforming to IEC 60947-5-1 appendix C 5000000 cycles, DC-13, 48 V, 2 W, operating rate <60 cyc/mn, load factor: 0.5 conforming to IEC 60947-5-1 appendix C
Mechanical durability	5000000 cycles
Width	30 mm
Height	182 mm

Depth	16 mm
Net weight	0.08 kg



Environment

Shock resistance	25 gn for 18 ms conforming to IEC 60068-2-27
Vibration resistance	5 gn (f= 10...500 Hz) conforming to IEC 60068-2-6
IP degree of protection	IP66 conforming to IEC 60529 IP67 conforming to IEC 60529
IK degree of protection	IK04 conforming to EN 50102
Electrical shock protection class	Class II conforming to IEC 61140 Class II conforming to NF C 20-030
Ambient air temperature for operation	-25...70 °C
Ambient air temperature for storage	-40...70 °C
Protective treatment	TC
Product certifications	CCC UL CSA
Standards	EN/IEC 60204-1 UL 508 CSA C22.2 No 14 EN/IEC 60947-5-1

Packing Units

Unit Type of Package 1	PCE
Number of Units in Package 1	1
Package 1 Height	1.6 cm
Package 1 Width	20 cm
Package 1 Length	25 cm
Package 1 Weight	68 g

Offer Sustainability

REACH Regulation	 REACH Declaration
EU RoHS Directive	Pro-active compliance (Product out of EU RoHS legal scope)  EU RoHS Declaration
Mercury free	Yes
RoHS exemption information	 Yes
WEEE	The product must be disposed on European Union markets following specific waste collection and never end up in rubbish bins
California proposition 65	WARNING: This product can expose you to chemicals including: Diisononyl phthalate (DINP), which is known to the State of California to cause cancer, and Di-isodecyl phthalate (DIDP), which is known to the State of California to cause birth defects or other reproductive harm. For more information go to www.P65Warnings.ca.gov

Contractual warranty

Warranty	18 months
----------	-----------

Dimensions

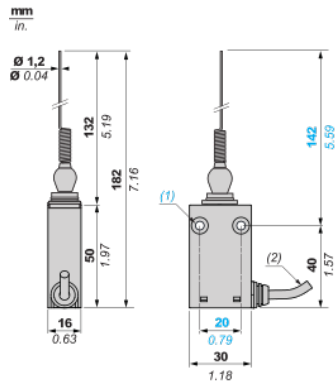

- (1) 2 fixing holes $\varnothing 4.2$ mm (0.16 in.), counterbored $\varnothing 8$ mm by 4 mm deep (counterbored $\varnothing 0.32$ in. by 0.16 in. deep).
- (2) Cable external diameter: 4.2 mm (0.16 in.)

Mounting and Clearance

Mounting: distance required for connection



d : min.15 mm/min.0.59 in.

Sweep of Connecting Cable

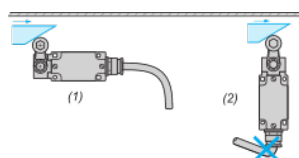

(1) : Recommended

(2) : To be avoided

Mounting with Spacers



(1) : 2 spacers supplied with the switch

(2) : 2 screws Ø 4mm (not included)

Wiring diagram

2-pole NC + NO snap action

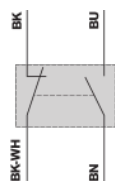

(BK) Black

(BK-WH) Black White

(BN) Brown

(BU) Blue

Characteristics of Actuation

Switch Actuation by Any Moving Part

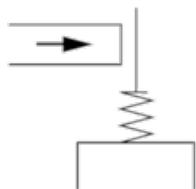

Functional Diagram

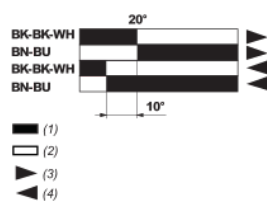

(1) Closed

(2) Open

(3) Tripping

(4) Resetting

(BK) Black

(BK-WH) Black White

(BN) Brown

(BU) Blue