

XCMH21F2L1

XCMH Limit Switches Miniature Plastic M12 head metal roller plunger NC + NO Snap L1



Main

Range of product	Telemecanique Limit switches XC Standard
Series name	Standard format
Product or component type	Limit switch
Device short name	XCMH
Sensor design	Miniature
Body type	Fixed
Head type	M12 plunger head
Material	Plastic
Body material	Plastic
Head material	Zamak
Fixing mode	By the head
Movement of operating head	Linear
Type of operator	Spring return roller plunger metal
Type of approach	Lateral approach, 2 directions
Number of poles	2
Contacts type and composition	1 NC + 1 NO
Contact operation	Snap action

Complementary

Switch actuation	By 30° cam
Electrical connection	Fixed cable
Cable length	1 m
Cable composition	4 x 0.34 mm ²
Wire insulation material	PvR
Contacts insulation form	Zb
Positive opening	With
Positive opening minimum force	35 N
Minimum force for tripping	7 N
Maximum actuation speed	10 cm/s
Contact code designation	C300, AC-15 (U _e = 240 V), I _e = 0.75 A conforming to EN/IEC 60947-5-1 appendix A R300, DC-13 (U _e = 250 V), I _e = 0.1 A conforming to EN/IEC 60947-5-1 appendix A
[U _i] rated insulation voltage	300 V (pollution degree 3) conforming to UL 508 400 V (pollution degree 3) conforming to IEC 60947-5-1 300 V (pollution degree 3) conforming to CSA C22.2 No 14
Maximum resistance across terminals	25 MOhm conforming to IEC 60255-7 category 3
[U _{imp}] rated impulse withstand voltage	4 KV conforming to IEC 60664 4 kV conforming to IEC 60947-1
Short-circuit protection	6 A cartridge fuse, type gG
Electrical durability	5000000 Cycles, DC-13, 120 V, 1 W, operating rate <60 cyc/mn, load factor: 0.5 conforming to IEC 60947-5-1 appendix C 5000000 Cycles, DC-13, 24 V, 3 W, operating rate <60 cyc/mn, load factor: 0.5 conforming to IEC 60947-5-1 appendix C 5000000 cycles, DC-13, 48 V, 2 W, operating rate <60 cyc/mn, load factor: 0.5 conforming to IEC 60947-5-1 appendix C
Mechanical durability	5000000 cycles
Width	30 mm

The information provided in this documentation contains general descriptions and/or technical characteristics of the performance of the products contained herein. This documentation is not intended as a substitute for and is not to be used for determining suitability or reliability of these products for specific user applications. It is the duty of any such user or integrator to perform the appropriate and complete risk analysis, evaluation and testing of the products with respect to the relevant specific application or use thereof. Neither Schneider Electric Industries SAS nor any of its affiliates or subsidiaries shall be responsible or liable for misuse of the information contained herein.

Height	88 mm
Depth	16 mm
Net weight	0.095 kg



Environment

Shock resistance	25 gn for 18 ms conforming to IEC 60068-2-27
Vibration resistance	5 gn (f= 10...500 Hz) conforming to IEC 60068-2-6
IP degree of protection	IP66 conforming to IEC 60529 IP67 conforming to IEC 60529
IK degree of protection	IK04 conforming to EN 50102
Electrical shock protection class	Class II conforming to IEC 61140 Class II conforming to NF C 20-030
Ambient air temperature for operation	-25...70 °C
Ambient air temperature for storage	-40...70 °C
Protective treatment	TC
Product certifications	CSA CCC UL
Standards	EN/IEC 60947-5-1 EN/IEC 60204-1 CSA C22.2 No 14 UL 508

Packing Units

Unit Type of Package 1	PCE
Number of Units in Package 1	1
Package 1 Height	1.6 cm
Package 1 Width	20 cm
Package 1 Length	25 cm
Package 1 Weight	91 g

Offer Sustainability

REACH Regulation	 REACH Declaration
EU RoHS Directive	Pro-active compliance (Product out of EU RoHS legal scope)  EU RoHS Declaration
Mercury free	Yes
RoHS exemption information	 Yes
WEEE	The product must be disposed on European Union markets following specific waste collection and never end up in rubbish bins
California proposition 65	WARNING: This product can expose you to chemicals including: Diisononyl phthalate (DINP), which is known to the State of California to cause cancer, and Di-isodecyl phthalate (DIDP), which is known to the State of California to cause birth defects or other reproductive harm. For more information go to www.P65Warnings.ca.gov

Contractual warranty

Warranty	18 months
----------	-----------

Dimensions

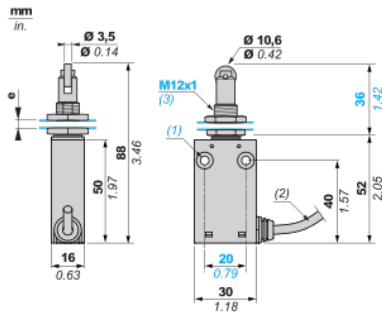

- (1) 2 fixing holes \varnothing 4.2 mm (0.16 in.), counterbored \varnothing 8 mm by 4 mm deep (counterbored \varnothing 0.32 in. by 0.16 in. deep).
 - (2) Cable external diameter: 4.2 mm (0.16 in.)
 - (3) Fixing nut thickness 3.5 mm (0.13 in.).
- e : 8 mm (0.32 in.) max, panel cut-out \varnothing 12.5 mm (0.49 in.).

Mounting and Clearance

Mounting: distance required for connection

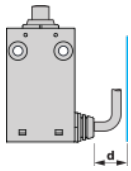

d : min.15 mm/min.0.59 in.

Sweep of Connecting Cable

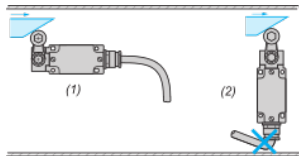

(1) : Recommended

(2) : To be avoided

Mounting with Spacers

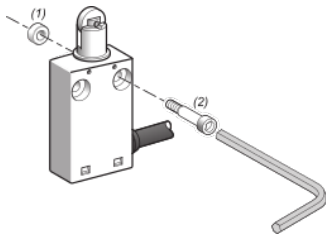

(1) : 2 spacers supplied with the switch

(2) : 2 screws Ø 4mm (not included)

Panel Mounting

Mounting and Fixing Limit Switches by the Head

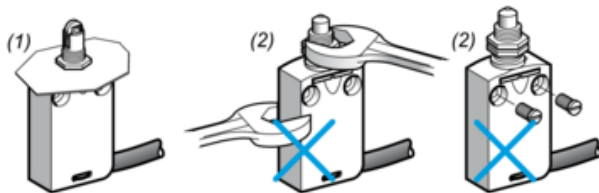

(1) Recommended

(2) Forbidden

Wiring diagram

2-pole NC + NO snap action

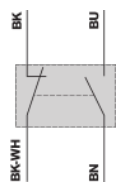

(BK) Black

(BK-WH) Black White

(BN) Brown

(BU) Blue

Characteristics of Actuation

Switch Actuation by 30° Cam

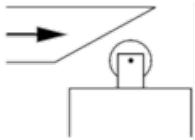

Functional Diagram

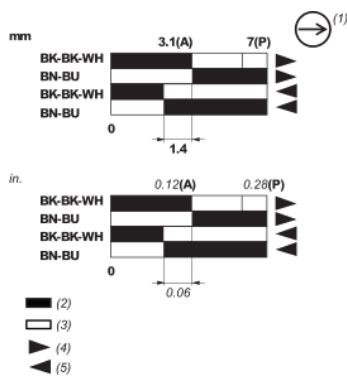

- (P) Positive opening point
- (A) Cam displacement
- (1) NC contact with positive opening operation
- (2) Closed
- (3) Open
- (4) Tripping
- (5) Resetting
- (BK) Black
- (BK-WH) Black White
- (BN) Brown
- (BU) Blue