

SL POWER NGB660 SERIES

660 Watts Single Output
Medical & Industrial Grade

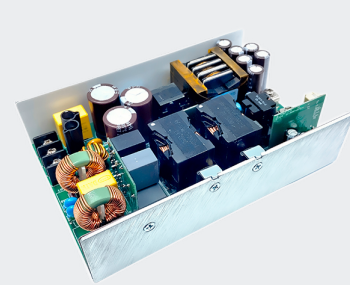

Medical



Industrial

Advanced Energy's SL Power NGB660 medically-approved AC-DC power supplies are available with a nominal main output of 12 V, 15 V, 24 V, or 48 V. NGB660 power supplies provide up to 660 Watts of output power with air flow. All models have output overvoltage, short circuit and overload protection and a 4 x 6 x 1.6 inch form factor.

AT A GLANCE

Total Power

660 Watts

Input Voltage

85 to 264 VAC

of Outputs

Single

SPECIAL FEATURES

- Up to 660 Watts with Air Flow
- Up to 440 Watts Convection Cooled
- 4" x 6" x 1.6" Size
- Universal Input 85 to 264 VAC
- Meets Class B Emissions Levels
- 10+ Years Electrolytic Capacitor Life
- Meets 4th Edition / Heavy Industrial EMC
- Meets Class B Emissions Levels
- Less than 100 uA Leakage Current
- Class I and Class II Input Versions Available
- -20°C to 80°C Operating Temperature Range
- ROHS Compliant
- REACH Compliant
- 3 Years Warranty

SAFETY

- CSA/UL/IEC60601-1, Am1
- IEC62368-1



ELECTRICAL SPECIFICATIONS

Input	
Input range	85 to 264 VAC, 47 to 63 Hz, 1Ø
Input current	7.0 A max at 115 VAC, 3.5 A max at 230 VAC
Inrush current	26.4 A max., cold start @ 264 VAC input (will not exceed 40A peak)
Input fuses	6.3 A, 250 VAC fuse provided in both line & neutral
Leakage current	Earth <500 µA @ 264 VAC, 60 Hz, NC Patient (output to earth) <100/500 µA @ 264 VAC, 60 Hz, NC/SFC
Efficiency	>90% typical
No load input power	<0.5 W
Isolation voltage	Input/Ground: 1500 VAC (1 MOPP) Input/Output: 4500 VAC (2 MOPP) Output/Ground: 1500 VAC (1 MOPP)
Output	
Maximum power	See "Ordering information" section
Ripple and noise	1% of Vout on all other models
Load regulation	2%
Line regulation	1%
Total regulation	5%
Minimum load	Not required
Capacitive load	1000 µF
Adjustment range	5%
Initial set point tolerance	±1 %
Overshoot	<5% overshoot at turn-on, <1% overshoot at turn-off, under all conditions
Monotonic waveform	PSU have monotonic wave forms on the main output at start up, shut down and fault (OVP, OCP, OTP, OPP, SCP) triggered shutdown.
Transient response	500 µs response time for return to within 0.5% of final value for any 50% load step over the range of 25% to 100% of rated load, $\Delta i/\Delta t < 0.2 \text{ A}/\mu\text{s}$. Max. voltage deviation is ±3.5% of final value.
Reliability	
MTBF	>500K hrs, 25°C, full rated load at 110 VAC input.
Warranty	3 years
Electrolytic capacitor lifetime	All specified electrolytic capacitors will exceed 10 year life based on operating at 25°C ambient temp., 24 hrs/day, 365 days/year, 6 power up cycles/day.
Protection	
Overvoltage protection	115% to 155% of nominal output voltage. Hiccup mode.
Short circuit protection	Short across the output terminals will not cause damage to the unit. Latch mode.
Thermal protection	Will shutdown upon an over temperature condition. Auto-recovery mode.
Overload protection	130% to 180% of rated output current value. Hiccup mode.

POWER DERATING

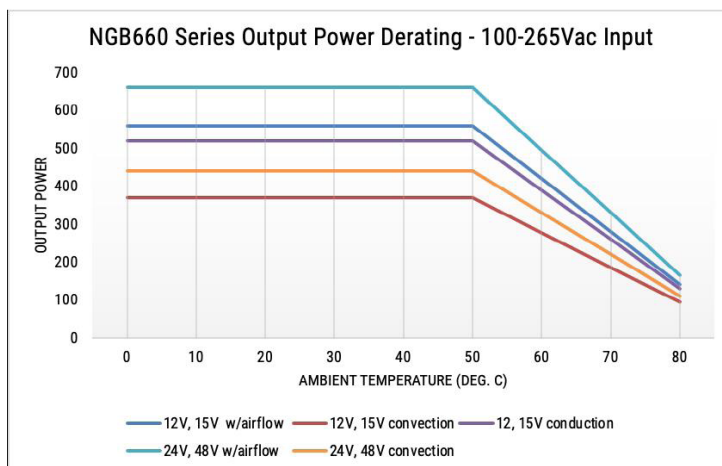

EMI/EMC COMPLIANCE

Conducted emissions	EN55011/15/32: Class B, CISPR11/15/32: Class B, FCC Part 15.107, Class B, Measured at 10%, 50%, and 100% load steps; 6db margin typ, at 120 VAC and 230 VAC
Radiated emissions ²	EN55011/15/32: Class B, CISPR11/15/32: Class B, FCC Part 15.107, Class B, Measured at 10%, 50%, and 100% load steps; 3db margin typ, at 120 VAC and 230 VAC
Harmonic current emissions	EN61000-3-2, Class A at 230 VAC, 100% load
Voltage fluctuations & flicker	IEC61000-3-3
Electro static discharge immunity	EN55024/IEC61000-4-2, Level 4: ±8kV contact, ±15kV air, Criteria A, IEC60601-1-2, 4th Edition, Table 4
Radiated RF EM fields susceptibility	EN55022/EN61000-4-3, 10 V/m, 80 MHz to 2.7 GHz, 80% AM at 1 kHz IEC60601-1-2, 4th Edition, Table 4
Electrical fast transients / bursts	EN55024/IEC61000-4-4, Level 4, ±4 kV, 100 KHz rep rate, 40 A, Criteria A, IEC60601-1-2, 4th Edition, Table 5
Surges line to line (DM) and line to ground (CM)	EN55024/IEC61000-4-5, Level 4, ±2kV DM, ±4kV CM, Criteria A Surpasses IEC60601-1-2, 4th Edition requirements
Conducted disturbances induced by RF fields	EN55022/IEC61000-4-6, 3 V/m – Level 4, 0.15 to 80 MHz; and 12V/m in ISM and amateur radio bands between 0.15 MHz and 80 MHz, 80% AM at 1 KHz IEC60601-1-2, 4th Edition, Table 5
Rated power frequency magnetic fields test	EN55024/IEC1000-4-8, Level 4: 30 A/m, 50Hz/60Hz IEC60601-1-2, 4th Edition, Table 4
Voltage dips ³	EN55024/IEC/EN61000-4-11: --100% dip for 10 ms, at 0°, 45°, 90°, 135°, 180°, 225°, 270° and 315° --100% dip for 20 ms, 0°, criteria B --100% dip for 5000 ms (250/300 cycles), criteria B --60% dip for 100 ms, criteria B --30% dip for 500 ms, criteria A IEC60601-1-2, 4th Edition, Table 5
Common mode noise: high freq. (100 KHz to 20 MHz)	500 mA pk-pk

Notes:

- Performance criteria are based on EN55024. According to the standards, performance criteria are decoded as following:
 - A. Normal performance during and after the test
 - B. Temporary degradation, self-recoverable
 - C. Temporary degradation, operator intervention required to recover the operation
 - D. Permanent damage
- Class II models meet Class A radiated emissions. Class B can be met with added ferrite on input cable. Consult Advanced Energy for details.
- 100% dip for 20 ms Criteria A @ 80% load; 30% dip for 500 ms Criteria A @ 80% load.

SYSTEM TIMING SPECIFICATIONS

Model Number	Min	Typ	Max	Unit
Turn-On Time – Main outputs	500	-	1000	ms
Turn-On Time – 5Vsb output	-	-	100	ms
Rise Time, 10% Vmain to Vmain in regulation	-	-	100	ms
Hold Up Time - All outputs stay within regulation after loss of AC @ 80% load	20	-	-	ms
Hold Up Time - Vsb stays within regulation after loss of AC	100	-	-	ms
Turn-On Time at -20°C	-	300	-	ms

ENVIRONMENTAL SPECIFICATIONS

Vibration	Random Vibration: Operating: 0.003 g/Hz, 1.5 grams overall, 3 axes, 10 min/axis, 5 to 500 Hz. Non-operating: Random waveform, 3 mins/axis, 3 axes and sine waveform, Vib. frequency / acceleration:10 Hz to 500 Hz / 1 g, sweep rate of 1 octave/minutes, vibration time of 10 sweeps/axes, 3 axes. Transportation vibration: Random vib. per MIL-STD-810E, Method 514.4, Cat. 1, Figure 514.4-1, 1hr in each of three axes.
Shock (IEC 60068-2-27)	Operating: Half-sine, 20 gpk, 10 ms, 3 axes, 6 shocks total. Non-operating: Half-sine waveform, impact acceleration of 50 g, pulse duration of 6 ms. Number of shocks: 3 for each of the three axis
Cooling	Airflow: ≥300LFM. Convection.
Audible noise	<20 dbA
Operating temperature	-20°C to +80°C
Temperature derating	Derate output power above 50°C, see derating curve for details
Storage temperature	-40°C to +85°C
Altitude	Operating: -500 to 5,000 m. Non-operating: -500 to 12,192 m
Relative humidity	5% to 95%, non-condensing

ORDERING INFORMATION

Model Number	Output Voltage	With Air ¹		Convection		Conduction		Standby Output ²	Terminations	
		Output Current	Output Power	Output Current	Output Power	Output Current	Output Power		Input	Output
NGB660S12K	12 V	46.2 A	560 W	30.6 A	370 W	38.9 A	470 W	5 V @ 1A	Screw Terminals (Class I)	Screw Terminals
NGB660S15K	15 V	37.0 A	560 W	24.5 A	370 W	31.1 A	470 W			
NGB660S24K	24 V	27.2 A	660 W	18.2 A	440 W	21.5 A	520 W			
NGB660S48K	48 V	13.6 A	660 W	9.1 A	440 W	10.7 A	520 W			
NGB660S12C	12 V	46.2 A	560 W	30.6 A	370 W	38.9 A	470 W	5 V @ 1A	Screw Terminals (Class II)	Screw Terminals
NGB660S15C	15 V	37.0 A	560 W	24.5 A	370 W	31.1 A	470 W			
NGB660S24C	24 V	27.2 A	660 W	18.2 A	440 W	21.5 A	520 W			
NGB660S48C	48 V	13.6 A	660 W	9.1 A	440 W	10.7 A	520 W			

Note:

1. Airflow: ≥300LFM.

2. Standby 5V output current: 1A @ 300LFM; 0.5A @ convection and conduction.

UNIT PACKAGING REQUIREMENTS

Inserted instructions	Instruction sheet to be provided with all units packaged in individual unit box if used.
Individual unit packing	Units can be packed in egg crate type cartons for production quantities. Individual product shipments include an individual unit box.
Master carton shipping box	16 units per master carton. Unit packaged into carton must be protected such that it will sustain 1.4m drop test onto hard surface. Only anti-static packing material may be used inside the box. Exterior box sealing tape is anti-static type.
Individual carton packing box (when used)	Individual carton is labelled with ROHS sticker and individual label showing unit serial number, bar code, manufacturing date, bar code, and manufacturing part number, bar code, country of origin.

SAFETY

UL	UL62368-1, UL60601-1-1, 3rd Edition + Am1. Complies with BF rated application requirements.
CSA	CAN/CSA-C22.2 No. 62368-1, 60601-1, Am1
Demko	EN62368-1 EN60601-1-1, 3rd Edition. Complies with BF rated application requirements.
CB Report	Design to meet 5000 m and 50°C, 93% RH with 120 h (Tropical standard) according to GB4943 1-2011, IEC62368-1, IEC60601-1-1 Am1, complies with BF rated application requirements.

PIN ASSIGNMENTS

Type	Connector	Pin #	Assignment	Mating Connector
INPUT	J100	1	AC Line	Molex: 19141-0052/0053
		2	AC Neutral	
		3	Ground	
OUTPUT	J103	1	+Vout	Molex: 19141-0058/0063/0065/0059/0064 /0066
	J104	2	-Vout	
	J400	1	RTN	Housing: LANDWIN: 2050S1400 or JST PHDR-14VS Pins: LANDWIN: 2053T021N
		2	NA	
		3	S+	
		4	RTN	
		5	NA	
		6	DC OK	
		7	NA	
		8	ON_OFF	
		9	NA	
		10	NA	
		11	RTN	
		12	NA	
13	5VSB			
14	5VSB			

MECHANICAL DRAWING

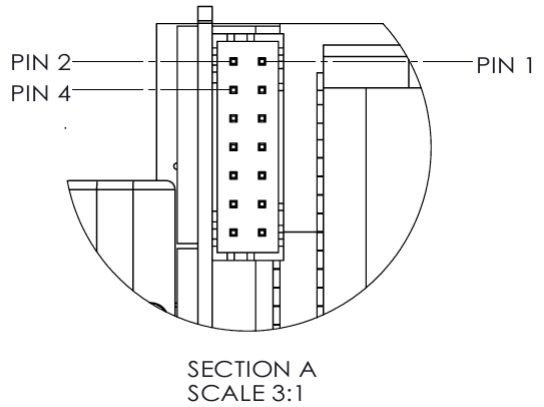
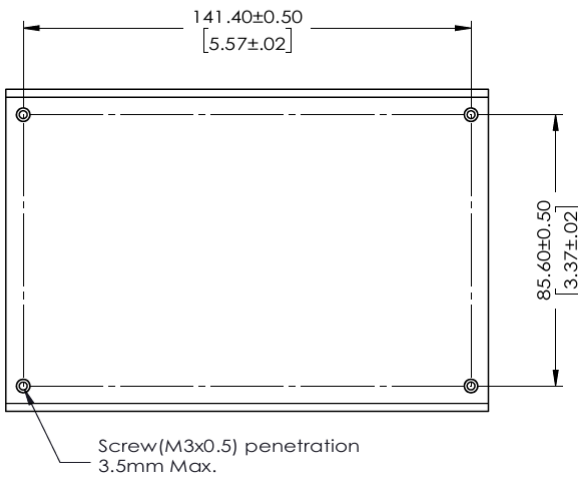
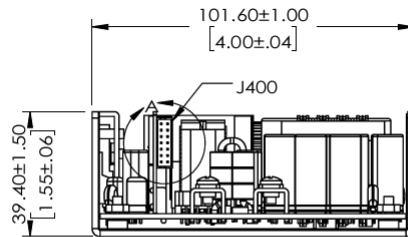
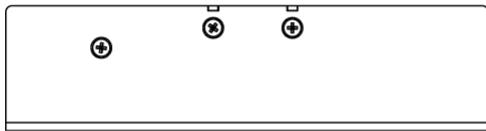
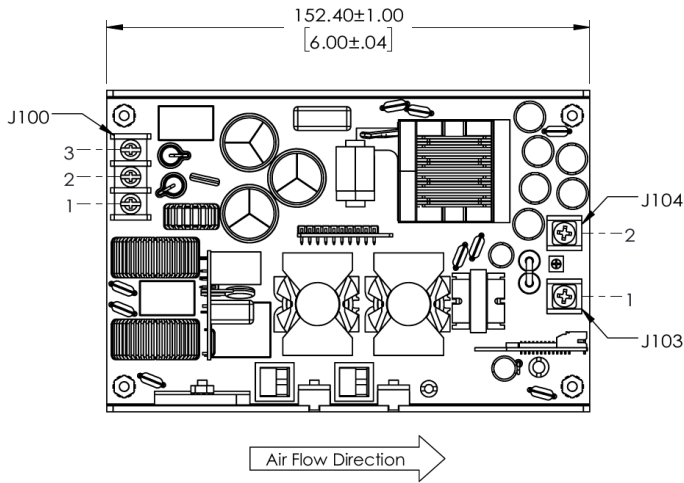

Notes:

1. All dimensions in mm (inches).
2. Dimensions: W: 4" Wx L: 6" x H: 1.6".
3. Unit weight: 830 g.



For international contact information,
visit advancedenergy.com.

powersales@aei.com (Sales Support)
productsupport.ep@aei.com (Technical Support)
+1 888 412 7832

ABOUT ADVANCED ENERGY

Advanced Energy (AE) has devoted more than three decades to perfecting power for its global customers. AE designs and manufactures highly engineered, precision power conversion, measurement and control solutions for mission-critical applications and processes.

Our products enable customer innovation in complex applications for a wide range of industries including semiconductor equipment, industrial, manufacturing, telecommunications, data center computing, and medical. With deep applications know-how and responsive service and support across the globe, we build collaborative partnerships to meet rapid technological developments, propel growth for our customers, and innovate the future of power.

PRECISION | POWER | PERFORMANCE | TRUST

Specifications are subject to change without notice. Not responsible for errors or omissions. ©2022 Advanced Energy Industries, Inc. All rights reserved. Advanced Energy®, and AE® are U.S. trademarks of Advanced Energy Industries, Inc.