

VarioPlate Insert Grommet Large Single 18-19 mm

Art.-No. 440-00026 | VP-L_18-19_Ins-sgl-PL-BK | [Details](#)

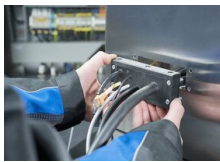

- Integrated cable diameter tolerance compensation
- Modular application for both insert sizes (S and L)
- Integrated strain relief
- IP 65 and IP 66

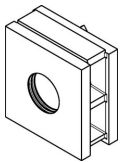
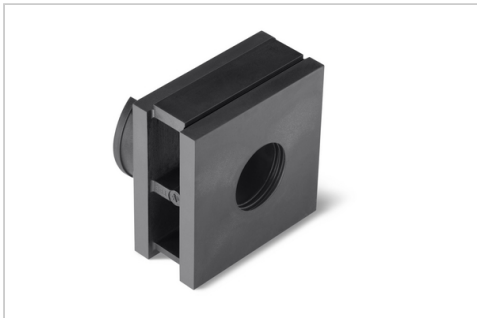

More products in this product group:

[VarioPlate Cable Entry System >](#)

Base Data

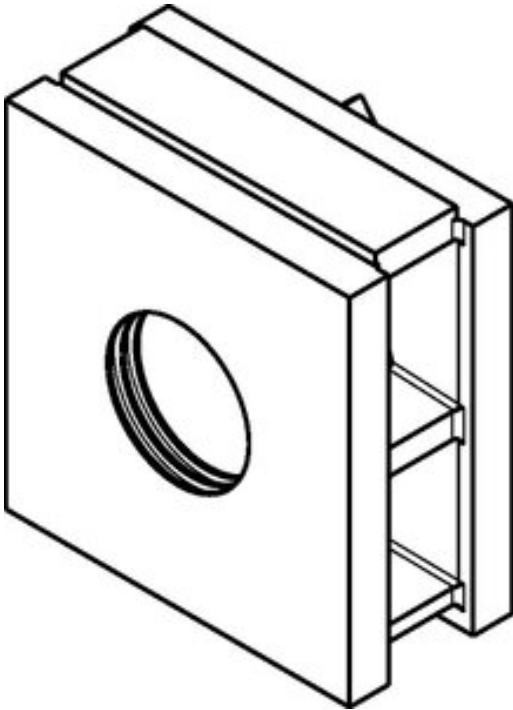

Application	VarioPlate cable entry system inserts grommets are used in combination with VarioPlate frames for time and space saving cable installation on all types of panel builder housings and controll boxes. The versatile design covers cable diameter from 3 to 33mm. Inserts grommets are available in one, two, four holes and blindplugs.
Application Tool	VP Mounting Tool
Cable ø max	19.0 mm
Cable ø min	18.0 mm
Colour	Black (BK)
Description	VarioPlate Insert Grommet Large Single 18-19 mm
Material	Plastic (PL)
Pack Content	10 pcs.
Package Content packed in	bag
PART DESCRIPTION	VP-L_18-19_Ins-sgl-PL-BK
Product Family	VarioPlate Insert Grommet Large Single 18-19 mm
Product Group	VarioPlate Cable Entry System
Variant	Both sides open

Product Dimensions



Depth (D)	32.00 mm
Height (H)	43.6 mm
Length (L)	42.2 mm
Width (W)	42.2 mm

Specifications

ELV compliant (Article 4 - 2)	YES
Flammability	UL 94 V0
Halogen-free	Yes
Hazardous good	No
IP-Rating	IP66
Operating Temperature	-40 °C to +100 °C
Self extinguishing (Yes/No)	Yes
Specifications	  
Specifications	csa-C22.2 No. 94.1, csa-C22.2 No. 94.2, UL 50, UL 50E
UL OCD link	Link Link
UL-File Number	E526974

Logistics and Packaging

GTIN-13 / EAN	4031026686479
Packaging 1 - Height (m)	0.065 m
Packaging 1 - Length (m)	0.22 m
Packaging 1 - Qty	10
Packaging 1 - Type	carton
Packaging 1 - Volume (m ³)	0.00106 m ³
Packaging 1 - Weight (kg)	0.3 kg
Packaging 1 - Width (m)	0.074 m
Packaging 2 - Height (m)	0.216 m
Packaging 2 - Length (m)	0.3048 m
Packaging 2 - Volume (m ³)	0.0176 m ³
Packaging 2 - Width (m)	0.267 m

More Information

Subscribe to our newsletter > 