

G9KA

PCB Power Relays

High Power and Temperature Type Power Relay with 800 VAC 200 A / 1,000 VAC 300 A Breaking and Ultra-Low Contact Resistance

- Ambient temperature 85°C
- High impulse withstand voltage, 10 kV
- Contact gap ≥ 4.0 mm (Applied to VDE0126)
- Low initial contact resistance ≤ 0.2 m Ω (when 200 A of current is applied)
- Rises in board temperatures are suppressed by a low heat generation and high dissipation structure.

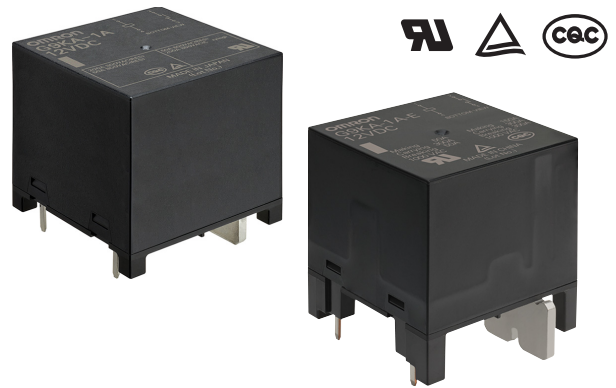

As this relay is a high-voltage and high-current type, be sure to refer to the Precautions on page 6 before use.

Model Number Legend

G9KA-□□-□
1 2 3

- | | | |
|--------------------|-----------------|--------------------------|
| 1. Number of Poles | 2. Contact Form | 3. Special specification |
| 1: 1-pole | A: SPST-NO (1a) | E: High-capacity type |

Application Examples

- Power conditioner inverter
- Industrial inverter
- UPS

G
9
K
A

Ordering Information

Terminal shape	Contact form	Enclosure rating	Model	Rated coil voltage (V)	Minimum packing unit
Standard	SPST-NO (1a)	Flux protection	G9KA-1A G9KA-1A-E	12 VDC 24 VDC	36pcs/box

Note. When ordering, add the rated coil voltage to the model number.

Example: G9KA-1A DC12

□ Rated coil voltage

Both the coil voltage on the product case and the packing will be marked as □□VDC.

Ratings

● Coil

Item	Rated current (mA)	Coil resistance (Ω)	Must operate voltage (V)	Must release voltage (V)	Max. voltage (V)	Power consumption (mW)
			% of rated voltage			
Rated voltage						
12 VDC	Approx. 417	28.8	75% max. *	5 to 35%	120% (at 23°C)	Approx. 5,000 Approx. 1,012 *
24 VDC	Approx. 208	115.2				

Note 1. The rated current and resistance are measured at a coil temperature of 23°C with a tolerance of $\pm 10\%$.

Note 2. The operating characteristics are measured at a coil temperature of 23°C.

Note 3. The maximum permissible voltage is the maximum value of the fluctuation range for the relay coil operating power supply and was measured at an ambient temperature of 23°C.

Note 4. Use this relay with coil voltage reduction.

* Power consumption with holding voltage is approx. 1,012 mW (when applying holding voltage at 45%). Please confirm the details on page 6, under ●Coil Voltage Reduction (holding voltage) after Relay Operation.

● Contacts

Item	Standard type	High-capacity type
Contact type	Double make	
Contact material	Ag Alloy (Cd free)	
Rated load	50 A at 800 VAC/ 800 VAC making 150 A, carrying 200 A, breaking 200 A 200 A at 60 VDC	1,000 VAC making 50 A, carrying 300 A, breaking 50 A 1,000 VAC making 150 A, carrying 300 A, breaking 300 A
Rated carry current	200 A	300 A
Max. switching voltage	800 VAC	1,000 VAC
Max. switching current	200 A	300 A

Characteristics

Item	Model	G9KA-1A	G9KA-1A-E
Contact resistance *1		0.2 mΩ max.	
Operate time *2		30 ms max.	
Release time *2		10 ms max.	
Insulation resistance *3		1,000 MΩ min.	
Dielectric strength	Between coil and contacts	5,000 VAC, 50/60 Hz for 1 min	
	Between contacts of the same polarity	2,000 VAC, 50/60 Hz for 1 min	
Impulse withstand voltage	Between coil and contacts	10 kV (1.2 × 50 μs)	
Vibration resistance	Destruction	10 to 55 to 10 Hz, 0.5 mm single amplitude (1.0 mm double amplitude)	
	Malfunction	Excitation: 10 to 55 to 10 Hz, 0.5 mm single amplitude (1.0 mm double amplitude)	
Shock resistance	Destruction	1,000 m/s ²	
	Malfunction	Excitation: 1,000 m/s ²	
Durability	Mechanical	100,000 operations min. (at 18,000 operations/h)	
	Electrical (Resistive) *4	800 VAC making 50 A, carrying 200 A, breaking 50 A; 30,000 operations min. 800 VAC making 150 A, carrying 200 A, breaking 200 A; 10 operations min. 200 A at 60 VDC; 2,000 operations min. (Switching frequency: 1 second ON - 9 seconds OFF at 85°C)	1,000 VAC making 50 A, carrying 300 A, breaking 50 A; 30,000 operations min. 1,000 VAC making 150 A, carrying 300 A, breaking 300 A; 10 operations min. (Switching frequency: 1 second ON - 9 seconds OFF at 85°C)
Failure rate (M level) (Reference value) *5		1 A at 5 VDC	
Use conditions	Coil holding voltage *6	45% to 65% of rated coil voltage	
	Ambient operating temperature	-40°C to +85°C (with no icing or condensation)	
	Ambient operating humidity	5% to 85%	
Weight		Approx. 220 g	Approx. 235 g

Note. The values given above are initial values at 23°C. (Except Electrical Durability)

*1. Measurement conditions: 200 A at 6 VDC (after 30 minutes) voltage drop method.

*2. Measurement conditions: Applied rated coil voltage, no contact bouncing.

*3. Measurement conditions: Measured with a 1,000 VDC megohmmeter at the same point as the dielectric strength was measured.

*4. This specification is when diode and zener diode are used. For relay coil, please connect diode and zener diode.

For more detail, please refer to ●Diode Connection for Operating Coil on page 6.

*5. The value was measured at a switching frequency of 180 operations/ minute.

*6. For the detail regarding holding voltage usage, please refer to ●Coil Voltage Reduction (holding voltage) after Relay Operation on page 6.

Malfunction shock resistance

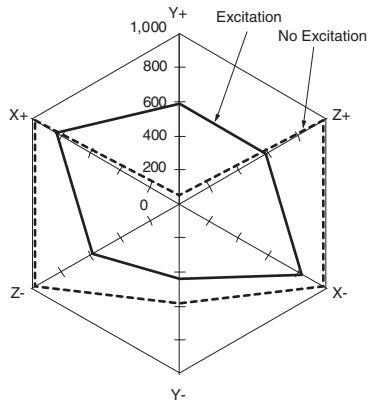

Measurement:

Measure the value of contact malfunction happening by applying 3 axes with 6 direction 3 times each.

The energized voltage is within the range of the rated holding voltage.

Standard value:

Excitation 100 m/s²

Shock direction

G9KA-1A

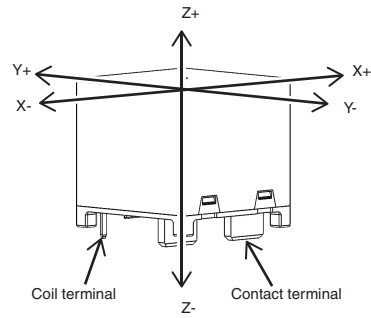

G9KA-1A-E

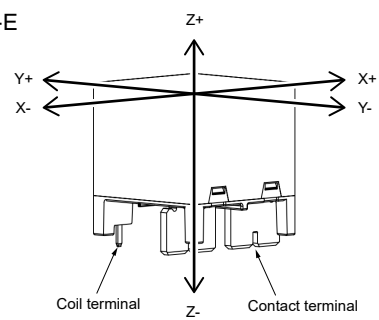

G
9
K
A

Dimensions

CAD Data

Please visit our website, which is noted on the last page.

(Unit:mm)

Standard type

G9KA-1A

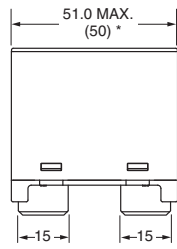
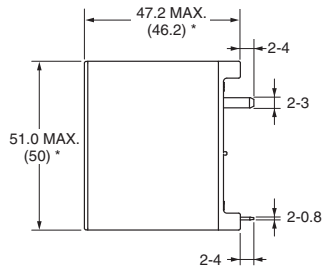

*Average value

**Terminal Arrangement/
Internal Connections
(BOTTOM VIEW)**

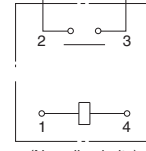

(No coil polarity)

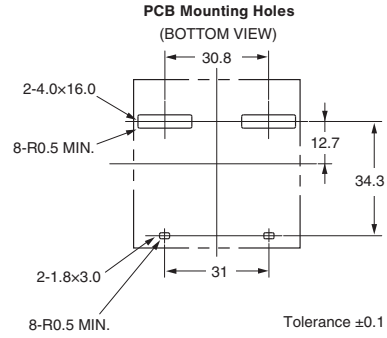
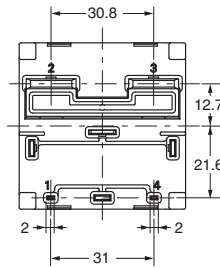

CAD Data

G9KA-1A-E

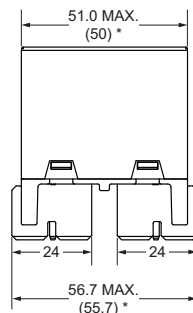
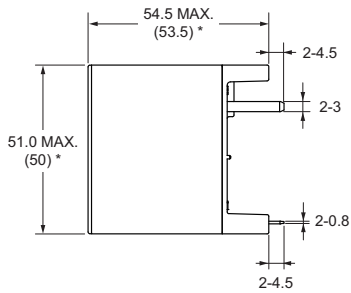

* Average value

**Terminal Arrangement/
Internal Connections
(BOTTOM VIEW)**

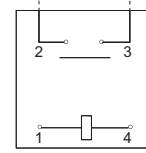

(No coil polarity)

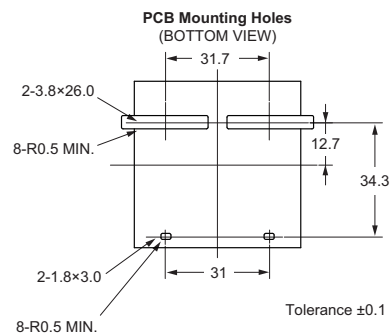
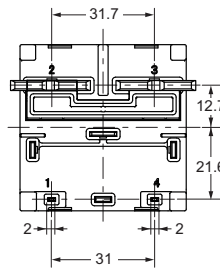

CAD Data

Approval Standard

UL Recognized:  (File No. E41515)

Model	Contact form	Coil ratings	Contact ratings	Number of test operations
G9KA-1A	SPST-NO (1a)	12, 24 VDC	800 VAC 50 A (Resistive) at 85°C	30,000
			800 VAC 50 A switch on, 200 A carry current, 50 A switch off at 85°C	30,000
G9KA-1A-E	SPST-NO (1a)	12, 24 VDC	1,000 VAC making 50 A, carrying 300 A, breaking 50 A at 85°C	30,000
			1,000 VAC making 50 A, carrying 300 A, breaking 50 A at 85°C	10

EN/IEC, TÜV Certificated:  (Certificate No. R50459726)

Model	Contact form	Coil ratings	Contact ratings	Number of test operations
G9KA-1A	SPST-NO (1a)	12, 24 VDC	800 VAC 50 A (Resistive) at 85°C	30,000
			carrying 200 A at 85°C	-
G9KA-1A-E	SPST-NO (1a)	12, 24 VDC	1,000 VAC making 50 A, carrying 300 A, breaking 50 A at 85°C	30,000
			1,000 VAC making 50 A, carrying 300 A, breaking 50 A at 85°C	10

CQC Certificated:  (Certificate No. CQC20002275617)

Model	Contact form	Coil ratings	Contact ratings	Number of test operations
G9KA-1A	SPST-NO (1a)	12, 24 VDC	800 VAC 50 A (Resistive) at 85°C	30,000
			carrying 200 A at 85°C	-
G9KA-1A-E	SPST-NO (1a)	12, 24 VDC	1,000 VAC making 50 A, carrying 300 A, breaking 50 A at 85°C	30,000
			1,000 VAC making 50 A, carrying 300 A, breaking 50 A at 85°C	10

G
9
K
A

G9KA-1A

Creepage distance (required value)	12.5 mm min. (IEC/UL)	
Clearance (required value)	8 mm min. (IEC/UL)	
Insulation material group	III	
Type of insulation	coil-contact circuit	Basic (800 V, OV-cat. III, up to 2,000 m above sea level) Basic (800 V, OV-cat. II, up to 4,000 m above sea level)
	open contact circuit	Micro disconnection
Rated insulation system	800 V	
Pollution degree	3	
Rated voltage system	800 V	
Category of protection (IEC61810-1)	RTII	
Flammability class (UL94)	V-0	
Coil insulation system (UL)	Class F	

G9KA-1A-E

Creepage distance (required value)	16 mm min. (IEC/UL)	
Clearance (required value)	8 mm min. (IEC/UL)	
Insulation material group	III	
Type of insulation	coil-contact circuit	Basic (1,000 V, OV-cat. III, up to 2,000 m above sea level) Basic (1,000 V, OV-cat. II, up to 4,000 m above sea level)
	open contact circuit	Micro disconnection
Rated insulation system	1,000 V	
Pollution degree	3	
Rated voltage system	1,000 V	
Category of protection (IEC61810-1)	RTII	
Flammability class (UL94)	V-0	
Coil insulation system (UL)	Class F	

Precautions

● Refer to *PCB Relays Common Precautions* for general precautions.

Warning

As this relay is a high-voltage and high-current type, there is a risk of abnormal heat generation, smoke generation or fire if you use the relay with a contact voltage, current, or for a number of times beyond the specified range. Use only within the specified ranges.



If the power is switched on when the connections are insufficient, there is a risk of abnormal heat generation. Do not connect and use probes and sockets on individual relays.



If the power is switched on when the connections are insufficient, there is a risk of abnormal heat generation. Please install and use relays under recommended conditions.



Precautions for Safe Use

● Drop

- Do not use relays that have been dropped as they may not function properly.

Precautions for Correct Use

● Coil Voltage Reduction (holding voltage) after Relay Operation

- Use this relay with coil voltage reduction.
- Apply the rated voltage for 0.1 to 3 seconds to the coil first.
- The range of coil rated voltage must be set as 100 to 120%, and holding voltage must be 45 to 60%. Do not exceed the ranges due to the change of coil voltage change and so on.

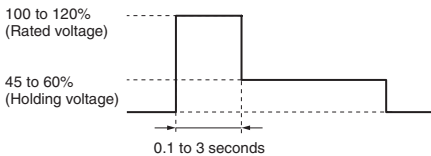

	Applied coil voltage	Coil resistance *	Coil power consumption
Rated voltage	100 to 120%	28.8 Ω (DC12)	Approx. 5 to 7.2 W
Holding voltage	45 to 60%	115.2 Ω (DC24)	Approx. 1.0 to 1.8 W

* The coil resistances were measured at a coil temperature of 23°C with tolerances of ± 10%.

● Diode Connection for Operating Coil

- Connect diode and zener diode (or varistor) to the coil (refer to the picture below).
Diode is for coil surge absorption. Ensure to include zener diode as there is a possibility of any influence for switching capability when only using diodes.
- Coil has no polarity. Connect the diodes in the reverse polarity of the voltage applied to the coil.
- The recommended zener diode voltage is 3 times that of the rated coil voltage.

- Use diodes with reverse dielectric strength 10 times or more that of coil rated voltage, and with forward current more than coil rated current.

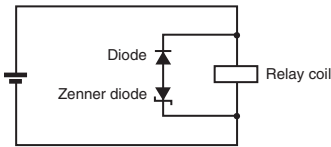

● PCB Terminal Soldering

- Perform soldering under the following conditions.
G9KA-1A: Preheat at 120°C for 60 seconds and dip in solder bath at 290°C for up to 20 seconds.
G9KA-1A-E: Preheat at 120°C for 300 seconds and dip in a solder bath at 290°C for up to 30 seconds.
- It is not possible to wash relay as this is not fully sealed type.

● Assembly

- To reduce the risk of specification deterioration, assemble relays in a dust free, low humidity and non-corrosive gas environment.
- Using the relay under high temperature, high humidity, or harmful gas may deteriorate its performance characteristics due to condensation or corrosive materials, resulting in failure or burn damage to the relay.
- This product weight is about 220 to 235 g. Be careful of the strength of PCB. To reduce soldering crack due to heat stress, use both sides through hole PCB.

● Electrical Endurance

- This relay's electrical endurance specification is based on our company's standard test procedure with resistive loads. Relays intended for use with remove; types of drive circuits PWM, capacitive, resistive dropper etc.), types of loads (e.g. capacitive or inductive), and switching cycles (duty and operation timing) must be tested to confirm suitability to the actual intended application.
- The final failure mode is failure to break the circuit. In such a case, burning may extend to surrounding components. Implement safety circuits and other measures to minimize the risk of mechanical failure.

● Micro Load

- This is a power relay for high power switching. Do not use for micro loads such as signal switching.

Please check each region's Terms & Conditions by region website.

OMRON Corporation

Device & Module Solutions Company

Regional Contact

Americas

<https://components.omron.com/us>

Asia-Pacific

<https://components.omron.com/ap>

Korea

<https://components.omron.com/kr>

Europe

<https://components.omron.com/eu>

China

<https://components.omron.com.cn>

Japan

<https://components.omron.com/jp>

Mouser Electronics

Authorized Distributor

Click to View Pricing, Inventory, Delivery & Lifecycle Information:

Omron:

[G9KA-1A-E DC12](#) [G9KA-1A-E DC24](#)