

Data Sheet | Item Number: 2050-301

2-conductor miniature through terminal block; with operating slots; 1 mm²; End terminal block with mounting flange; side and center marking; with test port; Push-in CAGE CLAMP®; 1,00 mm²; gray

<https://www.wago.com/2050-301>

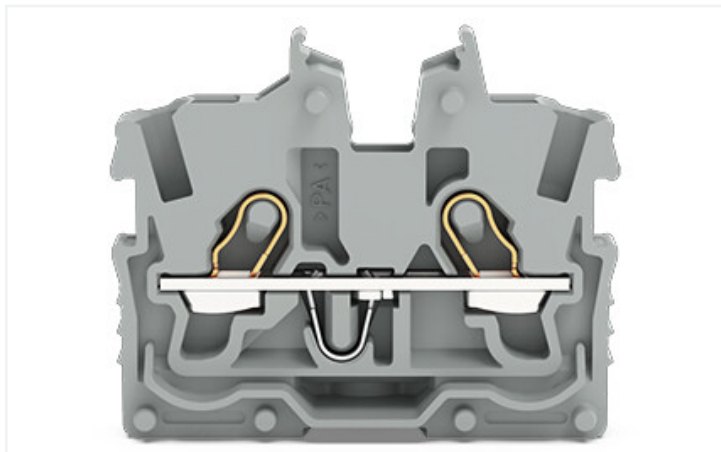

Color: ■ gray



Similar to illustration

Modular terminal blocks and terminal strips with mounting flanges
L = (pole no. x 3.5 mm) + 4.3 mm + 6.1 mm

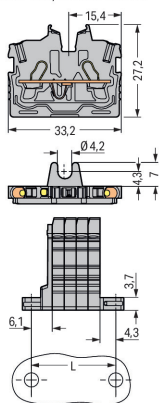

Electrical data

Ratings per IEC/EN

Ratings per	IEC/EN 60998-2-2
Nominal voltage (III/3)	500 V
Rated impulse voltage (III/3)	6 kV
Rated current	13.5 A
Current at conductor cross-section (max.) mm ²	17.5 A
Legend (ratings)	(III / 3) ≙ Overvoltage category III / Pollution degree 3

Ratings per UL 1059

Approvals per	UL 1059
Rated voltage UL (Use Group B)	300 V
Rated current UL (Use Group B)	10 A
Rated voltage UL (Use Group C)	300 V
Rated current UL (Use Group C)	10 A

Ratings per CSA

Approvals per	CSA 22.2 No 158
Rated voltage CSA (Use Group B)	300 V
Rated current CSA (Use Group B)	10 A
Rated voltage CSA (Use Group C)	300 V
Rated current CSA (Use Group C)	10 A

Ex information

Reference hazardous areas	See "Downloads – Documentation – Additional Information: Technical Section; Technical Explanations"
Ratings per	ATEX: PTB 19 ATEX 1019 U / IECEx: PTB 19.0050U (Ex eb IIC Gb)
Rated voltage EN (Ex e II)	352 V
Rated current (Ex e II)	13.5 A
Rated current (Ex e II) with jumper	12 A

Power loss

Power loss, per pole (potential)	0.4338 W
Rated current I_N for specified power loss	13.5 A
Resistance value for specified, current-dependent power loss	0.00238 Ω

Connection data

Connection points	2
Total number of potentials	1
Number of levels	1
Number of jumper slots	1

Connection 1

Connection technology	Push-in CAGE CLAMP®
Actuation type	Operating tool
Connectable conductor materials	Copper
Nominal cross-section	1 mm ²
Solid conductor	0.14 ... 1.5 mm ² / 24 ... 16 AWG
Solid conductor; push-in termination	0.5 ... 1.5 mm ² / 20 ... 16 AWG
Fine-stranded conductor	0.14 ... 1.5 mm ² / 24 ... 16 AWG
Fine-stranded conductor; with insulated ferrule	0.14 ... 0.75 mm ² / 24 ... 18 AWG
Fine-stranded conductor; with ferrule; push-in termination	0.5 ... 0.75 mm ² / 20 ... 18 AWG
Note (conductor cross-section)	Depending on the conductor characteristic, a conductor with a smaller cross-section can also be inserted via push-in termination.
Strip length	9 ... 11 mm / 0.35 ... 0.43 inches
Wiring direction	Front-entry wiring

Physical data

Width	3.5 mm / 0.138 inches
Height from the surface	27.2 mm / 1.071 inches
Depth	33.2 mm / 1.307 inches

Mechanical data

Mounting type	Mounting flange
Marking level	Center/side marking

Material data

Note (material data)	Information on material specifications can be found here
Color	gray
Material group	I
Insulation material	Polyamide (PA66)
Flammability class per UL94	V0
Fire load	0 MJ
Weight	2.5 g

Environmental requirements

Processing temperature	-35 ... +85 °C
Continuous operating temperature	-60 ... +105 °C

Commercial data

ETIM 8.0	EC001284
ETIM 7.0	EC001284
PU (SPU)	100 pcs
Country of origin	DE
GTIN	4055143968645
Customs tariff number	85369010000

Approvals / Certificates

General approvals



Approval	Standard	Certificate Name
CCA DEKRA Certification B.V.	EN 60998	NTR NL 7840
CSA CSA	C22.2 No. 158	80034182
cURus Underwriters Laboratories Inc.	UL 1059	E45172
KEMA/KEUR DEKRA Certification B.V.	EN 60998	71-113957

Declarations of conformity and manufacturer's declarations

Approval	Standard	Certificate Name
EU-Declaration of Confor- mity WAGO GmbH & Co. KG	-	-
UK-Declaration of Confor- mity WAGO GmbH & Co. KG	-	-

Approvals for hazardous areas



Approval	Standard	Certificate Name
AEx Underwriters Laboratories Inc.	UL 60079	E185892 (AEx eb IIC resp. Ex eb IIC)
ATEX Physikalisch Technische Bundesanstalt	EN IEC 60079-0	PTB 19 ATEX 1019 U (II 2G Ex eb IIC Gb or I M 2 Ex eb I Mb)
CCC CNEX	GB/T 3836.3	2020312313000289 (Ex eb IIC Gb, Ex eb I Mb)
IECEX Physikalisch Technische Bundesanstalt	IEC 60079	IECEX PTB 19.0050U (Ex eb IIC Gb or EX eb I Mb)
INMETRO TÜV Rheinland do Brasil Ltda.	IEC 60079	TÜV 22.0014 U

Downloads

Environmental Product Compliance

Compliance Search	
Environmental Product Compliance 2050-301	↓

Documentation

Additional Information	
Technical Section	pdf 2142.18 KB ↓

CAD/CAE-Data

CAD data	
2D/3D Models 2050-301	↓

CAE data	
EPLAN Data Portal 2050-301	↓
WSCAD Universe 2050-301	↓
ZUKEN Portal 2050-301	↓

1 Compatible Products

1.1 System counterpart

1.1.1 Through terminal block



Item No.: 2050-321

2-conductor miniature through terminal block; with operating slots; 1 mm²; Center terminal block without snap-in mounting foot, without mounting flange; side and center marking; with test port; Push-in CA-GE CLAMP®; 1,00 mm²; gray

1.2 Required Accessories

1.2.1 End plate

1.2.1.1 End plate



Item No.: 2050-381

End plate; with fixing flange; 1.3 mm thick; gray

1.3 Optional Accessories

1.3.1 Ferrule

1.3.1.1 Ferrule



Item No.: 216-241
 Ferrule; Sleeve for 0.5 mm² / 20 AWG; insulated; electro-tin plated; electrolytic copper; gastight crimped; acc. to DIN 46228, Part 4/09.90; white

Item No.: 216-242
 Ferrule; Sleeve for 0.75 mm² / 18 AWG; insulated; electro-tin plated; electrolytic copper; gastight crimped; acc. to DIN 46228, Part 4/09.90; gray

Item No.: 216-243
 Ferrule; Sleeve for 1 mm² / AWG 18; insulated; electro-tin plated; electrolytic copper; gastight crimped; acc. to DIN 46228, Part 4/09.90; red

1.3.2 Installation

1.3.2.1 Mounting accessories



Item No.: 209-137
 Mounting adapter; can be used as end stop; 6.5 mm wide; gray

Item No.: 209-123
 Mounting foot with screw; can be screwed on terminal blocks with fixing flange; 6.4 mm wide; gray

1.3.3 Jumper

1.3.3.1 Jumper



Item No.: 2000-406/020-000
 Delta jumper; insulated; light gray

Item No.: 2000-410/000-006
 Jumper; 10-way; insulated; blue

Item No.: 2000-410
 Jumper; 10-way; insulated; light gray

Item No.: 2000-410/000-005
 Jumper; 10-way; insulated; red



Item No.: 2000-402/000-006
 Jumper; 2-way; insulated; blue

Item No.: 2000-402
 Jumper; 2-way; insulated; light gray

Item No.: 2000-402/000-005
 Jumper; 2-way; insulated; red

Item No.: 2000-402/000-018
 Jumper; 2-way; insulated; yellow-green



Item No.: 2000-403/000-006
 Jumper; 3-way; insulated; blue

Item No.: 2000-403
 Jumper; 3-way; insulated; light gray

Item No.: 2000-403/000-005
 Jumper; 3-way; insulated; red

Item No.: 2000-404/000-006
 Jumper; 4-way; insulated; blue



Item No.: 2000-404
 Jumper; 4-way; insulated; light gray

Item No.: 2000-404/000-005
 Jumper; 4-way; insulated; red

Item No.: 2000-405/000-006
 Jumper; 5-way; insulated; blue

Item No.: 2000-405
 Jumper; 5-way; insulated; light gray



Item No.: 2000-405/000-005
 Jumper; 5-way; insulated; red

Item No.: 2000-406/000-006
 Jumper; 6-way; insulated; blue

Item No.: 2000-406
 Jumper; 6-way; insulated; light gray

Item No.: 2000-406/000-005
 Jumper; 6-way; insulated; red



Item No.: 2000-407/000-006
 Jumper; 7-way; insulated; blue

Item No.: 2000-407
 Jumper; 7-way; insulated; light gray

Item No.: 2000-407/000-005
 Jumper; 7-way; insulated; red

Item No.: 2000-408/000-006
 Jumper; 8-way; insulated; blue



Item No.: 2000-408
 Jumper; 8-way; insulated; light gray

Item No.: 2000-408/000-005
 Jumper; 8-way; insulated; red

Item No.: 2000-409/000-006
 Jumper; 9-way; insulated; blue

Item No.: 2000-409
 Jumper; 9-way; insulated; light gray



Item No.: 2000-409/000-005
 Jumper; 9-way; insulated; red

Item No.: 2000-440
 Jumper; from 1 to 10; insulated; light gray

Item No.: 2000-433/000-006
 Jumper; from 1 to 3; insulated; blue

Item No.: 2000-433
 Jumper; from 1 to 3; insulated; light gray



Item No.: 2000-433/000-005
 Jumper; from 1 to 3; insulated; red

Item No.: 2000-434
 Jumper; from 1 to 4; insulated; light gray

Item No.: 2000-435
 Jumper; from 1 to 5; insulated; light gray

Item No.: 2000-436
 Jumper; from 1 to 6; insulated; light gray

1.3.3.1 Jumper



Item No.: 2000-437

Jumper; from 1 to 7; insulated; light gray



Item No.: 2000-438

Jumper; from 1 to 8; insulated; light gray



Item No.: 2000-439

Jumper; from 1 to 9; insulated; light gray



Item No.: 2000-405/011-000

Star point jumper; 3-way; insulated; light gray

1.3.4 Marking

1.3.4.1 Group marker carrier



Item No.: 2009-191

Group marker carrier; gray

1.3.4.2 Marker



Item No.: 793-3501

WMB marking card; as card; plain; snap-on type; white



Item No.: 2009-113/000-006

WMB-Inline; for Smart Printer; 2300 pieces on roll; plain; snap-on type; blue



Item No.: 2009-113/000-007

WMB-Inline; for Smart Printer; 2300 pieces on roll; plain; snap-on type; gray



Item No.: 2009-113/000-023

WMB-Inline; for Smart Printer; 2300 pieces on roll; plain; snap-on type; green



Item No.: 2009-113/000-017

WMB-Inline; for Smart Printer; 2300 pieces on roll; plain; snap-on type; light green



Item No.: 2009-113/000-012

WMB-Inline; for Smart Printer; 2300 pieces on roll; plain; snap-on type; orange



Item No.: 2009-113/000-005

WMB-Inline; for Smart Printer; 2300 pieces on roll; plain; snap-on type; red



Item No.: 2009-113/000-024

WMB-Inline; for Smart Printer; 2300 pieces on roll; plain; snap-on type; violet



Item No.: 2009-113

WMB-Inline; for Smart Printer; 2300 pieces on roll; plain; snap-on type; white



Item No.: 2009-113/000-002

WMB-Inline; for Smart Printer; 2300 pieces on roll; plain; snap-on type; yellow

1.3.4.3 Marking strip



Item No.: 2009-110

Marking strips; for Smart Printer; on reel; not stretchable; plain; snap-on type; white

1.3.5 Protective warning marker

1.3.5.1 Cover



Item No.: 2000-115

Protective warning marker; for 5 terminal blocks; with high-voltage symbol, black; yellow

1.3.6 Push-in type wire jumper

1.3.6.1 Jumper



Item No.: 2009-404

Push-in type wire jumper; 0.75 mm²; insulated; 110 mm long; gray



Item No.: 2009-406

Push-in type wire jumper; 0.75 mm²; insulated; 250 mm long; gray



Item No.: 2009-402

Push-in type wire jumper; 0.75 mm²; insulated; 60 mm long; gray

1.3.7 Test and measurement

1.3.7.1 Testing accessories



Item No.: 2009-174

Test plug adapter; for 4 mm Ø test plugs; for testing TOPJOB®S rail-mounted terminal blocks; gray



Item No.: 210-136

Test plug; 2 mm Ø; with 500 mm cable; red



Item No.: 2009-182

Testing tap; for max. 2.5 mm²; tool-free connection for individual test wires 0.08 - 2.5 mm; gray

1.3.8 Tool

1.3.8.1 Operating tool



Item No.: 210-719

Operating tool; Blade: 2.5 x 0.4 mm; with a partially insulated shaft



Item No.: 210-648

Operating tool; Blade: 2.5 x 0.4 mm; with a partially insulated shaft; angled; short



Item No.: 210-647

Operating tool; Blade: 2.5 x 0.4 mm; with a partially insulated shaft; multicoloured

Installation Notes

Installation

Example of a 4-pole terminal strip with operating slots, with mounting flange

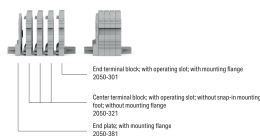

Conductor termination



Insert solid conductors via push-in termination.



Insert ferruled conductors via push-in termination.



Insert fine-stranded conductors via operating tool.

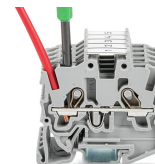

Remove all conductors via operating tool.

Commoning



Insert a delta jumper and push down until it hits the backstop (example shows terminal blocks with push-buttons).

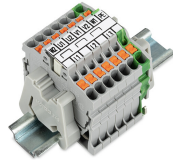

Marking strip (2009-110) inserted in the marking slot with jumper symbols of the inserted jumper (delta jumper) (example shows terminal blocks with push-buttons)



Insert a star point jumper and push down until it hits the backstop (example shows terminal blocks with push-buttons).

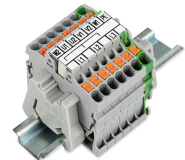

Marking strip (2009-110) inserted in the marking slot with jumper symbols of the inserted jumper (2000-405/011-000 Delta Jumper) (example shows terminal blocks with push-buttons)

Testing



Testing with a 2 mm Ø 210-136 Test Plug (max. 42 V).

Installation

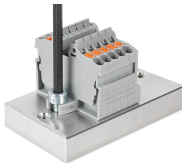

Mounting and securing a terminal strip directly to the plate via screw-type flanges (example shows terminal blocks with push-buttons).



Terminal strip; with mounting flanges; screw mounting (example shows terminal blocks with push-buttons)

Marking



Snapping a marking strip into the marker slot.



Snapping a marking strip (2009-110) into a marker slot.