

## Data Sheet | Item Number: 2052-311

2-conductor miniature through terminal block; with operating slots; 2.5 mm<sup>2</sup>; with snap-in mounting foot; side and center marking; with test port; Push-in CAGE CLAMP®; 2,50 mm<sup>2</sup>; gray

<https://www.wago.com/2052-311>

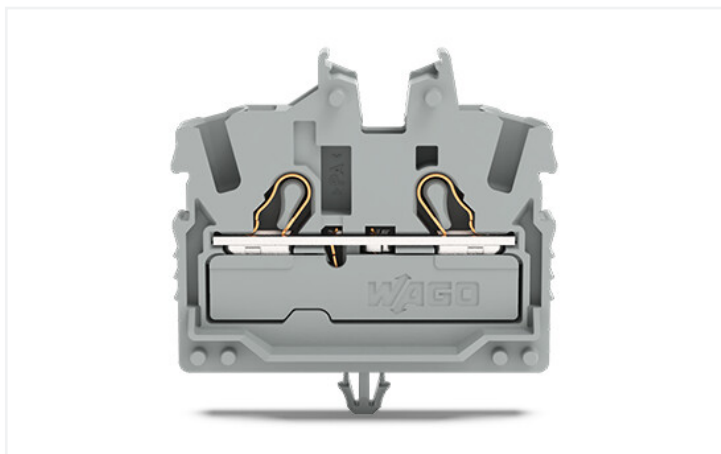

Color: ■ gray

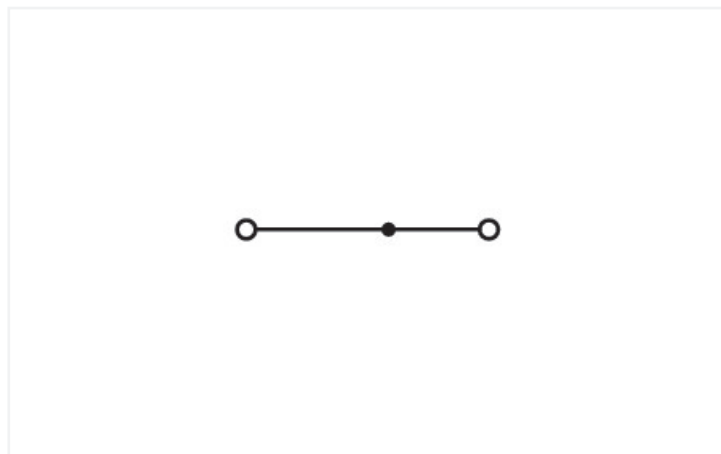

Similar to illustration

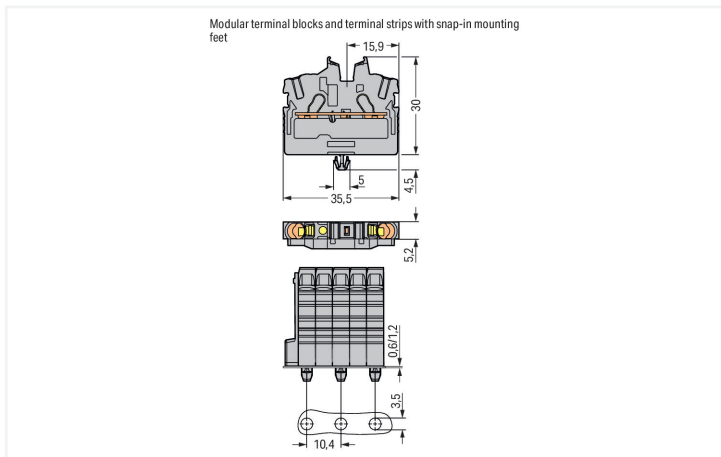

### Electrical data

#### Ratings per IEC/EN

Ratings per	IEC/EN 60998-2-2
Nominal voltage (III/3)	800 V
Rated impulse voltage (III/3)	8 kV
Rated current	24 A
Current at conductor cross-section (max.) mm <sup>2</sup>	32 A
Legend (ratings)	(III / 3) ≙ Overvoltage category III / Pollution degree 3

#### Ratings per UL 1059

Approvals per	UL 1059
Rated voltage UL (Use Group B)	600 V
Rated current UL (Use Group B)	20 A
Rated voltage UL (Use Group C)	600 V
Rated current UL (Use Group C)	20 A

#### Ratings per CSA

Approvals per	CSA 22.2 No 158
Rated voltage CSA (Use Group B)	600 V
Rated current CSA (Use Group B)	20 A
Rated voltage CSA (Use Group C)	600 V
Rated current CSA (Use Group C)	20 A

#### Ex information

Reference hazardous areas	See "Downloads – Documentation – Additional Information: Technical Section; Technical Explanations"
Ratings per	ATEX: PTB 20 ATEX 1013 U / IECEx: PTB 20.0029U (Ex eb IIC Gb)
Rated voltage EN (Ex e II)	550 V
Rated current (Ex e II)	22 A
Rated current (Ex e II) with jumper	20 A

### Power loss

Power loss, per pole (potential)	0.7661 W
Rated current $I_N$ for specified power loss	24 A
Resistance value for specified, current-dependent power loss	0.00133 $\Omega$

### Connection data

Connection points	2
Total number of potentials	1
Number of levels	1
Number of jumper slots	1

### Connection 1

Connection technology	Push-in CAGE CLAMP®
Actuation type	Operating tool
Connectable conductor materials	Copper
Nominal cross-section	2.5 mm <sup>2</sup>
Solid conductor	0.25 ... 4 mm <sup>2</sup> / 22 ... 12 AWG
Solid conductor; push-in termination	1 ... 4 mm <sup>2</sup> / 18 ... 12 AWG
Fine-stranded conductor	0.25 ... 4 mm <sup>2</sup> / 22 ... 12 AWG
Fine-stranded conductor; with insulated ferrule	0.25 ... 2.5 mm <sup>2</sup> / 22 ... 14 AWG
Fine-stranded conductor; with ferrule; push-in termination	1 ... 2.5 mm <sup>2</sup> / 18 ... 14 AWG
Note (conductor cross-section)	Depending on the conductor characteristic, a conductor with a smaller cross-section can also be inserted via push-in termination.
Strip length	10 ... 12 mm / 0.39 ... 0.47 inches
Wiring direction	Front-entry wiring

### Physical data

Width	5.2 mm / 0.205 inches
Height from the surface	30 mm / 1.181 inches
Depth	35.5 mm / 1.398 inches

### Mechanical data

Mounting type	Snap-in foot
Marking level	Center/side marking

### Material data

Note (material data)	<a href="#">Information on material specifications can be found here</a>
Color	gray
Material group	I
Insulation material	Polyamide (PA66)
Flammability class per UL94	V0
Fire load	0.091 MJ
Weight	4.2 g

## Environmental requirements

Processing temperature	-35 ... +85 °C
Continuous operating temperature	-60 ... +105 °C

## Commercial data

ETIM 8.0	EC001284
ETIM 7.0	EC001284
PU (SPU)	100 pcs
Country of origin	DE
GTIN	4066966146967
Customs tariff number	85369010000

## Approvals / Certificates

### General approvals



Approval	Standard	Certificate Name
CCA DEKRA Certification B.V.	EN 60998	NTR NL 7885
CSA DEKRA Certification B.V.	C22.2	80058059
KEMA/KEUR DEKRA Certification B.V.	EN 60998	71-119680
UL Underwriters Laboratories Inc.	UL 1059	E45172

### Declarations of conformity and manufacturer's declarations

Approval	Standard	Certificate Name
EU-Declaration of Confor- mity WAGO GmbH & Co. KG	-	-
UK-Declaration of Confor- mity WAGO GmbH & Co. KG	-	-

### Approvals for hazardous areas



Approval	Standard	Certificate Name
AEx Underwriters Laboratories Inc.	UL 60079	E185892 (AEx eb IIC resp. Ex eb IIC)
ATEX Physikalisch Technische Bundesanstalt	EN IEC 60079-0	PTB 20 ATEX 1013 U (II 2 G Ex eb IIC Gb bzw. I M 2 Ex eb I Mb)
IECEX Physikalisch Technische Bundesanstalt	IEC 60079	IECEX PTB 20.0029 U (Ex eb IIC Gb resp. Ex eb I Mb)
INMETRO TÜV Rheinland do Brasil Ltda.	IEC 60079	TÜV 22.0015 U

## Downloads

### Environmental Product Compliance

Compliance Search	
Environmental Product Compliance 2052-311	

## Documentation

Additional Information	
Technical Section	pdf 2142.18 KB

## CAD/CAE-Data

CAD data	
2D/3D Models 2052-311	

CAE data	
EPLAN Data Portal 2052-311	

ZUKEN Portal 2052-311	
-----------------------	--

## 1 Compatible Products

### 1.1 System counterpart

#### 1.1.1 Through terminal block



**Item No.: 2052-321**  
2-conductor miniature through terminal block; with operating slots; 2.5 mm<sup>2</sup>; Center terminal block without snap-in mounting foot, without mounting flange; side and center marking; with test port; Push-in CAGE CLAMP®; 2,50 mm<sup>2</sup>; gray

### 1.2 Required Accessories

#### 1.2.1 End plate

##### 1.2.1.1 End plate



**Item No.: 2052-391**  
End plate; gray

### 1.3 Optional Accessories

#### 1.3.1 DIN-rail

### 1.3.1.1 Mounting accessories



**Item No.: 210-154**

Aluminum carrier rail; 1000 mm long; 18 mm wide; 7 mm high; silver-colored

### 1.3.2 Ferrule

#### 1.3.2.1 Ferrule



**Item No.: 216-241**

Ferrule; Sleeve for 0.5 mm<sup>2</sup> / 20 AWG; insulated; electro-tin plated; electrolytic copper; gastight crimped; acc. to DIN 46228, Part 4/09.90; white



**Item No.: 216-242**

Ferrule; Sleeve for 0.75 mm<sup>2</sup> / 18 AWG; insulated; electro-tin plated; electrolytic copper; gastight crimped; acc. to DIN 46228, Part 4/09.90; gray



**Item No.: 216-262**

Ferrule; Sleeve for 0.75 mm<sup>2</sup> / 18 AWG; insulated; electro-tin plated; electrolytic copper; gastight crimped; acc. to DIN 46228, Part 4/09.90; gray



**Item No.: 216-243**

Ferrule; Sleeve for 1 mm<sup>2</sup> / AWG 18; insulated; electro-tin plated; electrolytic copper; gastight crimped; acc. to DIN 46228, Part 4/09.90; red



**Item No.: 216-263**

Ferrule; Sleeve for 1 mm<sup>2</sup> / AWG 18; insulated; electro-tin plated; electrolytic copper; gastight crimped; acc. to DIN 46228, Part 4/09.90; red



**Item No.: 216-244**

Ferrule; Sleeve for 1.5 mm<sup>2</sup> / AWG 16; insulated; electro-tin plated; electrolytic copper; gastight crimped; acc. to DIN 46228, Part 4/09.90; black



**Item No.: 216-264**

Ferrule; Sleeve for 1.5 mm<sup>2</sup> / AWG 16; insulated; electro-tin plated; electrolytic copper; gastight crimped; acc. to DIN 46228, Part 4/09.90; black



**Item No.: 216-246**

Ferrule; Sleeve for 2.5 mm<sup>2</sup> / AWG 14; insulated; electro-tin plated; electrolytic copper; gastight crimped; acc. to DIN 46228, Part 4/09.90; blue



**Item No.: 216-266**

Ferrule; Sleeve for 2.5 mm<sup>2</sup> / AWG 14; insulated; electro-tin plated; electrolytic copper; gastight crimped; acc. to DIN 46228, Part 4/09.90; blue

### 1.3.3 Installation

#### 1.3.3.1 Mounting accessories



**Item No.: 209-137**

Mounting adapter; can be used as end stop; 6.5 mm wide; gray



**Item No.: 209-120**

Mounting foot; can be snapped on terminal blocks with snap-in mounting foot; for mounting on relay-modules; 6.4 mm wide; gray

### 1.3.4 Insulation stop

#### 1.3.4.1 Insulation stop



**Item No.: 2002-171**

Insulation stop; 0.25 - 0.5 mm<sup>2</sup>; 5 pieces/strip; light gray





















**Item No.: 2002-172**

Insulation stop; 0.75 - 1 mm<sup>2</sup>; 5 pieces/strip; dark gray

### 1.3.5 Jumper

1.3.5.1 Jumper

 <b>Item No.: 2002-400</b> Continuous jumper; 2-way; insulated; light gray	 <b>Item No.: 2002-423/000-006</b> Continuous jumper; from 1 to 3; insulated; blue	 <b>Item No.: 2002-423</b> Continuous jumper; from 1 to 3; insulated; light gray	 <b>Item No.: 2002-423/000-005</b> Continuous jumper; from 1 to 3; insulated; red
 <b>Item No.: 2002-424/000-006</b> Continuous jumper; from 1 to 4; insulated; blue	 <b>Item No.: 2002-424</b> Continuous jumper; from 1 to 4; insulated; light gray	 <b>Item No.: 2002-424/000-005</b> Continuous jumper; from 1 to 4; insulated; red	 <b>Item No.: 2002-406/020-000</b> Delta jumper; insulated; light gray
 <b>Item No.: 2002-410/000-006</b> Jumper; 10-way; insulated; blue	 <b>Item No.: 2002-410</b> Jumper; 10-way; insulated; light gray	 <b>Item No.: 2002-410/000-005</b> Jumper; 10-way; insulated; red	 <b>Item No.: 2002-402/000-006</b> Jumper; 2-way; insulated; blue
 <b>Item No.: 2002-402</b> Jumper; 2-way; insulated; light gray	 <b>Item No.: 2002-402/000-005</b> Jumper; 2-way; insulated; red	 <b>Item No.: 2002-403/000-006</b> Jumper; 3-way; insulated; blue	 <b>Item No.: 2002-403</b> Jumper; 3-way; insulated; light gray
 <b>Item No.: 2002-403/000-005</b> Jumper; 3-way; insulated; red	 <b>Item No.: 2002-404/000-006</b> Jumper; 4-way; insulated; blue	 <b>Item No.: 2002-404</b> Jumper; 4-way; insulated; light gray	 <b>Item No.: 2002-404/000-005</b> Jumper; 4-way; insulated; red
 <b>Item No.: 2002-405/000-006</b> Jumper; 5-way; insulated; blue	 <b>Item No.: 2002-405</b> Jumper; 5-way; insulated; light gray	 <b>Item No.: 2002-405/000-005</b> Jumper; 5-way; insulated; red	 <b>Item No.: 2002-406/000-006</b> Jumper; 6-way; insulated; blue
 <b>Item No.: 2002-406</b> Jumper; 6-way; insulated; light gray	 <b>Item No.: 2002-406/000-005</b> Jumper; 6-way; insulated; red	 <b>Item No.: 2002-407/000-006</b> Jumper; 7-way; insulated; blue	 <b>Item No.: 2002-407</b> Jumper; 7-way; insulated; light gray
 <b>Item No.: 2002-407/000-005</b> Jumper; 7-way; insulated; red	 <b>Item No.: 2002-408/000-006</b> Jumper; 8-way; insulated; blue	 <b>Item No.: 2002-408</b> Jumper; 8-way; insulated; light gray	 <b>Item No.: 2002-408/000-005</b> Jumper; 8-way; insulated; red
 <b>Item No.: 2002-409/000-006</b> Jumper; 9-way; insulated; blue	 <b>Item No.: 2002-409</b> Jumper; 9-way; insulated; light gray	 <b>Item No.: 2002-409/000-005</b> Jumper; 9-way; insulated; red	 <b>Item No.: 2002-440</b> Jumper; from 1 to 10; insulated; light gray
 <b>Item No.: 2002-433</b> Jumper; from 1 to 3; insulated; light gray	 <b>Item No.: 2002-434</b> Jumper; from 1 to 4; insulated; light gray	 <b>Item No.: 2002-435</b> Jumper; from 1 to 5; insulated; light gray	 <b>Item No.: 2002-436</b> Jumper; from 1 to 6; insulated; light gray
 <b>Item No.: 2002-437</b> Jumper; from 1 to 7; insulated; light gray	 <b>Item No.: 2002-438</b> Jumper; from 1 to 8; insulated; light gray	 <b>Item No.: 2002-439</b> Jumper; from 1 to 9; insulated; light gray	 <b>Item No.: 2002-480</b> Staggered jumper; 10-way; insulated; light gray
 <b>Item No.: 2002-481</b> Staggered jumper; 11-way; insulated; light gray	 <b>Item No.: 2002-482</b> Staggered jumper; 12-way; insulated; light gray	 <b>Item No.: 2002-473/011-000</b> Staggered jumper; 2-way; from 1 to 3; insulated; light gray	 <b>Item No.: 2002-472</b> Staggered jumper; 2-way; insulated; light gray
 <b>Item No.: 2002-473</b> Staggered jumper; 3-way; insulated; light gray	 <b>Item No.: 2002-475/011-000</b> Staggered jumper; 3-way; insulated; light gray	 <b>Item No.: 2002-474</b> Staggered jumper; 4-way; insulated; light gray	 <b>Item No.: 2002-475</b> Staggered jumper; 5-way; insulated; light gray
 <b>Item No.: 2002-476</b> Staggered jumper; 6-way; insulated; light gray	 <b>Item No.: 2002-477</b> Staggered jumper; 7-way; insulated; light gray	 <b>Item No.: 2002-478</b> Staggered jumper; 8-way; insulated; light gray	 <b>Item No.: 2002-479</b> Staggered jumper; 9-way; insulated; light gray

1.3.5.1 Jumper



**Item No.: 2002-477/011-000**  
Staggered jumper; insulated; light gray

**Item No.: 2002-479/011-000**  
Staggered jumper; insulated; light gray

**Item No.: 2002-481/011-000**  
Staggered jumper; insulated; light gray

**Item No.: 2002-405/011-000**  
Star point jumper; 3-way; insulated; light gray



**Item No.: 210-103**  
Wire commoning chain; insulated; black

**Item No.: 210-123**  
Wire commoning chain; insulated; blue

1.3.6 Marking

1.3.6.1 Group marker carrier



**Item No.: 2009-191**  
Group marker carrier; gray

**Item No.: 2009-192**  
Group marker carrier; gray

**Item No.: 2009-193**  
Group marker carrier; gray

1.3.6.2 Marker



**Item No.: 2009-145/000-006**  
Mini-WSB Inline; for Smart Printer; 1700 pieces on roll; stretchable 5 - 5.2 mm; plain; snap-on type; blue

**Item No.: 2009-145/000-007**  
Mini-WSB Inline; for Smart Printer; 1700 pieces on roll; stretchable 5 - 5.2 mm; plain; snap-on type; gray

**Item No.: 2009-145/000-023**  
Mini-WSB Inline; for Smart Printer; 1700 pieces on roll; stretchable 5 - 5.2 mm; plain; snap-on type; green

**Item No.: 2009-145/000-012**  
Mini-WSB Inline; for Smart Printer; 1700 pieces on roll; stretchable 5 - 5.2 mm; plain; snap-on type; orange



**Item No.: 2009-145/000-005**  
Mini-WSB Inline; for Smart Printer; 1700 pieces on roll; stretchable 5 - 5.2 mm; plain; snap-on type; red

**Item No.: 2009-145/000-024**  
Mini-WSB Inline; for Smart Printer; 1700 pieces on roll; stretchable 5 - 5.2 mm; plain; snap-on type; violet

**Item No.: 2009-145**  
Mini-WSB Inline; for Smart Printer; 1700 pieces on roll; stretchable 5 - 5.2 mm; plain; snap-on type; white

**Item No.: 2009-145/000-002**  
Mini-WSB Inline; for Smart Printer; 1700 pieces on roll; stretchable 5 - 5.2 mm; plain; snap-on type; yellow



**Item No.: 248-501/000-006**  
Mini-WSB marking card; as card; not stretchable; plain; snap-on type; blue

**Item No.: 248-501/000-007**  
Mini-WSB marking card; as card; not stretchable; plain; snap-on type; gray

**Item No.: 248-501/000-023**  
Mini-WSB marking card; as card; not stretchable; plain; snap-on type; green

**Item No.: 248-501/000-017**  
Mini-WSB marking card; as card; not stretchable; plain; snap-on type; light green



**Item No.: 248-501/000-012**  
Mini-WSB marking card; as card; not stretchable; plain; snap-on type; orange

**Item No.: 248-501/000-005**  
Mini-WSB marking card; as card; not stretchable; plain; snap-on type; red

**Item No.: 248-501/000-024**  
Mini-WSB marking card; as card; not stretchable; plain; snap-on type; violet

**Item No.: 248-501**  
Mini-WSB marking card; as card; not stretchable; plain; snap-on type; white



**Item No.: 248-501/000-002**  
Mini-WSB marking card; as card; not stretchable; plain; snap-on type; yellow

**Item No.: 793-5501/000-006**  
WMB marking card; as card; for terminal block width 5 - 17.5 mm; stretchable 5 - 5.2 mm; plain; snap-on type; blue

**Item No.: 793-5501/000-014**  
WMB marking card; as card; for terminal block width 5 - 17.5 mm; stretchable 5 - 5.2 mm; plain; snap-on type; brown

**Item No.: 793-5501/000-007**  
WMB marking card; as card; for terminal block width 5 - 17.5 mm; stretchable 5 - 5.2 mm; plain; snap-on type; gray



**Item No.: 793-5501/000-023**  
WMB marking card; as card; for terminal block width 5 - 17.5 mm; stretchable 5 - 5.2 mm; plain; snap-on type; green

**Item No.: 793-5501/000-017**  
WMB marking card; as card; for terminal block width 5 - 17.5 mm; stretchable 5 - 5.2 mm; plain; snap-on type; light green

**Item No.: 793-5501/000-012**  
WMB marking card; as card; for terminal block width 5 - 17.5 mm; stretchable 5 - 5.2 mm; plain; snap-on type; orange

**Item No.: 793-5501/000-005**  
WMB marking card; as card; for terminal block width 5 - 17.5 mm; stretchable 5 - 5.2 mm; plain; snap-on type; red



**Item No.: 793-5501/000-024**  
WMB marking card; as card; for terminal block width 5 - 17.5 mm; stretchable 5 - 5.2 mm; plain; snap-on type; violet

**Item No.: 793-5501**  
WMB marking card; as card; for terminal block width 5 - 17.5 mm; stretchable 5 - 5.2 mm; plain; snap-on type; white

**Item No.: 793-5501/000-002**  
WMB marking card; as card; for terminal block width 5 - 17.5 mm; stretchable 5 - 5.2 mm; plain; snap-on type; yellow

**Item No.: 2009-115/000-006**  
WMB-Inline; for Smart Printer; 1500 pieces on roll; stretchable 5 - 5.2 mm; plain; snap-on type; blue

### 1.3.6.2 Marker



**Item No.: 2009-115/000-007**

WMB-Inline; for Smart Printer; 1500 pieces on roll; stretchable 5 - 5.2 mm; plain; snap-on type; gray



**Item No.: 2009-115/000-023**

WMB-Inline; for Smart Printer; 1500 pieces on roll; stretchable 5 - 5.2 mm; plain; snap-on type; green



**Item No.: 2009-115/000-017**

WMB-Inline; for Smart Printer; 1500 pieces on roll; stretchable 5 - 5.2 mm; plain; snap-on type; light green



**Item No.: 2009-115/000-012**

WMB-Inline; for Smart Printer; 1500 pieces on roll; stretchable 5 - 5.2 mm; plain; snap-on type; orange



**Item No.: 2009-115/000-005**

WMB-Inline; for Smart Printer; 1500 pieces on roll; stretchable 5 - 5.2 mm; plain; snap-on type; red



**Item No.: 2009-115/000-024**

WMB-Inline; for Smart Printer; 1500 pieces on roll; stretchable 5 - 5.2 mm; plain; snap-on type; violet



**Item No.: 2009-115**

WMB-Inline; for Smart Printer; 1500 pieces on roll; stretchable 5 - 5.2 mm; plain; snap-on type; white



**Item No.: 2009-115/000-002**

WMB-Inline; for Smart Printer; 1500 pieces on roll; stretchable 5 - 5.2 mm; plain; snap-on type; yellow

### 1.3.6.3 Marker carrier



**Item No.: 2002-161**

Adaptor; gray



**Item No.: 2009-198**

Adaptor; gray

### 1.3.6.4 Marking strip



**Item No.: 2009-110**

Marking strips; for Smart Printer; on reel; not stretchable; plain; snap-on type; white

### 1.3.7 Protective warning marker

#### 1.3.7.1 Cover



**Item No.: 2002-115**

Protective warning marker; for 5 terminal blocks; with high-voltage symbol, black; yellow

### 1.3.8 Push-in type wire jumper

#### 1.3.8.1 Jumper



**Item No.: 2009-414**

Push-in type wire jumper; 1.5 mm<sup>2</sup>; insulated; 110 mm long; black



**Item No.: 2009-414/000-005**

Push-in type wire jumper; 1.5 mm<sup>2</sup>; insulated; 110 mm long; black



**Item No.: 2009-416**

Push-in type wire jumper; 1.5 mm<sup>2</sup>; insulated; 250 mm long; black



**Item No.: 2009-414/000-006**

Push-in type wire jumper; insulated; 110 mm long; black



**Item No.: 2009-412**

Push-in type wire jumper; insulated; 60 mm long; black

### 1.3.9 Test and measurement



### 1.3.9.1 Testing accessories



**Item No.: 2009-174**

Test plug adapter; for 4 mm Ø test plugs; for testing TOPJOB®S rail-mounted terminal blocks; gray



**Item No.: 210-136**

Test plug; 2 mm Ø; with 500 mm cable; red



**Item No.: 2009-182**

Testing tap; for max. 2.5 mm<sup>2</sup>; tool-free connection for individual test wires 0.08 - 2.5 mm; gray



**Item No.: 2002-649**

TOPJOB®S L-type spacer module; modular; e.g., for bridging commoned terminal blocks; gray



**Item No.: 2002-611**

TOPJOB®S L-type test plug module; modular; 1-pole; 2,50 mm<sup>2</sup>; gray

### 1.3.10 Tool

#### 1.3.10.1 Operating tool



**Item No.: 210-658**

Operating tool; Blade: 3.5 x 0.5 mm; with a partially insulated shaft; angled; short; multicoloured



**Item No.: 210-720**

Operating tool; Blade: 3.5 x 0.5 mm; with a partially insulated shaft; multicoloured

### Installation Notes

#### Installation

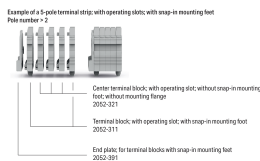

### Conductor termination



Insert solid conductors via push-in termination.



Insert ferruled conductors via push-in termination.



Insert fine-stranded conductors via operating tool.

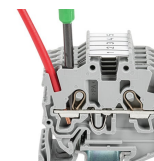

Remove all conductors via operating tool.

### Commoning

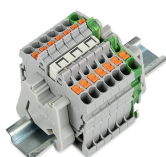

Insert a delta jumper and push down until it hits the backstop (example shows terminal blocks with push-buttons).

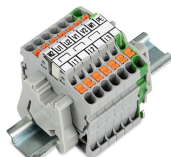

Marking strip (2009-110) inserted in the marking slot with jumper symbols of the inserted jumper (delta jumper) (example shows terminal blocks with push-buttons)

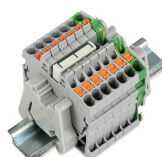

Insert a star point jumper and push down until it hits the backstop (example shows terminal blocks with push-buttons).

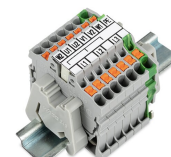

Marking strip (2009-110) inserted in the marking slot with jumper symbols of the inserted jumper (2000-405/011-000 Delta Jumper) (example shows terminal blocks with push-buttons)

## Testing



Testing with a 2 mm Ø 210-136 Test Plug (max. 42 V).

## Installation

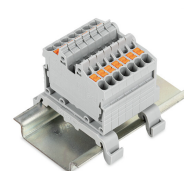
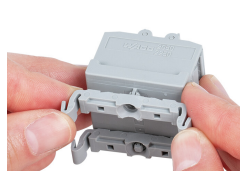

## Marking



Snapping a marking strip into the marker slot.



Snapping a marking strip (2009-110) into a marker slot.