

Data Sheet | Item Number: 2252-317

2-conductor miniature through terminal block; with push-button; 2.5 mm²; with snap-in mounting foot; side and center marking; with test port; Push-in CAGE CLAMP®; 2,50 mm²; green-yellow

<https://www.wago.com/2252-317>



Color:  green-yellow

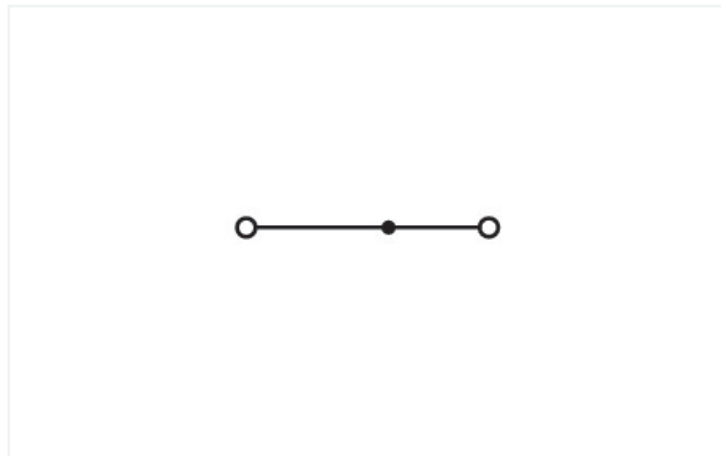

Similar to illustration

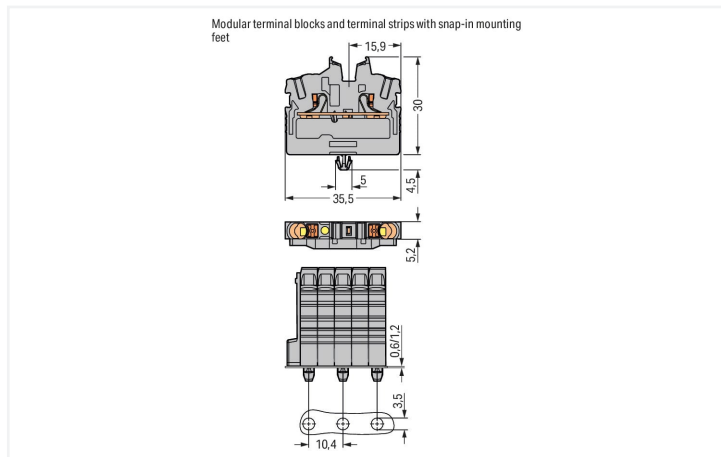

Electrical data

Ratings per IEC/EN

Ratings per	IEC/EN 60998-2-2
Nominal voltage (III/3)	800 V
Rated impulse voltage (III/3)	8 kV
Rated current	24 A

Ratings per UL 1059

Approvals per	UL 1059
Rated voltage UL (Use Group B)	600 V
Rated current UL (Use Group B)	20 A
Rated voltage UL (Use Group C)	600 V
Rated current UL (Use Group C)	20 A

Ratings per CSA

Approvals per	CSA 22.2 No 158
Rated voltage CSA (Use Group B)	600 V
Rated current CSA (Use Group B)	20 A
Rated voltage CSA (Use Group C)	600 V
Rated current CSA (Use Group C)	20 A

Ex information

Reference hazardous areas	See "Downloads – Documentation – Additional Information: Technical Section; Technical Explications"
Ratings per	ATEX: PTB 20 ATEX 1013 U / IECEx: PTB 20.0029U (Ex eb IIC Gb)
Rated voltage EN (Ex e II)	550 V
Rated current (Ex e II)	22 A
Rated current (Ex e II) with jumper	20 A

Connection data

Connection points	2
Total number of potentials	1
Number of levels	1
Number of jumper slots	1

Connection 1	
Connection technology	Push-in CAGE CLAMP®
Actuation type	Push-button
Connectable conductor materials	Copper
Nominal cross-section	2.5 mm ²
Solid conductor	0.25 ... 4 mm ² / 22 ... 12 AWG
Solid conductor; push-in termination	1 ... 4 mm ² / 18 ... 12 AWG
Fine-stranded conductor	0.25 ... 4 mm ² / 22 ... 12 AWG
Fine-stranded conductor; with insulated ferrule	0.25 ... 2.5 mm ² / 22 ... 14 AWG
Fine-stranded conductor; with ferrule; push-in termination	1 ... 2.5 mm ² / 18 ... 14 AWG
Note (conductor cross-section)	Depending on the conductor characteristic, a conductor with a smaller cross-section can also be inserted via push-in termination.
Strip length	10 ... 12 mm / 0.39 ... 0.47 inches
Wiring direction	Front-entry wiring

Physical data

Width	5.2 mm / 0.205 inches
Height from the surface	30 mm / 1.181 inches
Depth	35.5 mm / 1.398 inches

Mechanical data

Mounting type	Snap-in foot
Marking level	Center/side marking

Material data

Note (material data)	Information on material specifications can be found here
Color	green-yellow
Material group	I
Insulation material	Polyamide (PA66)
Flammability class per UL94	V0
Fire load	0.104 MJ
Weight	4.2 g

Environmental requirements

Processing temperature	-35 ... +85 °C
Continuous operating temperature	-60 ... +105 °C

Commercial data

ETIM 8.0	EC001284
ETIM 7.0	EC001284
PU (SPU)	100 pcs
Country of origin	DE
GTIN	4066966147094
Customs tariff number	85369010000

Approvals / Certificates

General approvals



Approval	Standard	Certificate Name
CCA DEKRA Certification B.V.	EN 60998	NTR NL 7885
CSA DEKRA Certification B.V.	C22.2	80058059
KEMA/KEUR DEKRA Certification B.V.	EN 60998	71-119680
UL Underwriters Laboratories Inc.	UL 1059	E45172

Declarations of conformity and manufacturer's declarations

Approval	Standard	Certificate Name
EU-Declaration of Confor- mity WAGO GmbH & Co. KG	-	-
UK-Declaration of Confor- mity WAGO GmbH & Co. KG	-	-

Approvals for hazardous areas



Approval	Standard	Certificate Name
AEx Underwriters Laboratories Inc.	UL 60079	E185892 (AEx eb IIC resp. Ex eb IIC)
ATEX Physikalisch Technische Bundesanstalt	EN IEC 60079-0	PTB 20 ATEX 1013 U (II 2 G Ex eb IIC Gb bzw. I M 2 Ex eb I Mb)
IECEx Physikalisch Technische Bundesanstalt	IEC 60079	IECEx PTB 20.0029 U (Ex eb IIC Gb resp. Ex eb I Mb)
INMETRO TÜV Rheinland do Brasil Ltda.	IEC 60079	TÜV 22.0015 U

Downloads

Environmental Product Compliance

Compliance Search

Environmental Product
Compliance 2252-317



Documentation

Additional Information

Technical Section

pdf
2142.18 KB



CAD/CAE-Data

CAD data

2D/3D Models
2252-317



CAE data

EPLAN Data Portal
2252-317



ZUKEN Portal
2252-317



1 Compatible Products

1.1 System counterpart

1.1.1 Through terminal block



Item No.: 2252-327

2-conductor miniature through terminal block; with push-button; 2.5 mm²; Center terminal block without snap-in mounting foot, without mounting flange; side and center marking; with test port; Push-in CA-GE CLAMP®; 2,50 mm²; green-yellow

1.2 Required Accessories

1.2.1 End plate

1.2.1.1 End plate



Item No.: 2052-391

End plate; gray

1.3 Optional Accessories

1.3.1 DIN-rail

1.3.1.1 Mounting accessories











Item No.: 210-154

Aluminum carrier rail; 1000 mm long; 18 mm wide; 7 mm high; silver-colored



1.3.2 Ferrule

1.3.2.1 Ferrule

 Item No.: 216-241 Ferrule; Sleeve for 0.5 mm ² / 20 AWG; insulated; electro-tin plated; electrolytic copper; gastight crimped; acc. to DIN 46228, Part 4/09.90; white	 Item No.: 216-242 Ferrule; Sleeve for 0.75 mm ² / 18 AWG; insulated; electro-tin plated; electrolytic copper; gastight crimped; acc. to DIN 46228, Part 4/09.90; gray	 Item No.: 216-262 Ferrule; Sleeve for 0.75 mm ² / 18 AWG; insulated; electro-tin plated; electrolytic copper; gastight crimped; acc. to DIN 46228, Part 4/09.90; gray	 Item No.: 216-243 Ferrule; Sleeve for 1 mm ² / AWG 18; insulated; electro-tin plated; electrolytic copper; gastight crimped; acc. to DIN 46228, Part 4/09.90; red
 Item No.: 216-263 Ferrule; Sleeve for 1 mm ² / AWG 18; insulated; electro-tin plated; electrolytic copper; gastight crimped; acc. to DIN 46228, Part 4/09.90; red	 Item No.: 216-244 Ferrule; Sleeve for 1.5 mm ² / AWG 16; insulated; electro-tin plated; electrolytic copper; gastight crimped; acc. to DIN 46228, Part 4/09.90; black	 Item No.: 216-264 Ferrule; Sleeve for 1.5 mm ² / AWG 16; insulated; electro-tin plated; electrolytic copper; gastight crimped; acc. to DIN 46228, Part 4/09.90; black	 Item No.: 216-246 Ferrule; Sleeve for 2.5 mm ² / AWG 14; insulated; electro-tin plated; electrolytic copper; gastight crimped; acc. to DIN 46228, Part 4/09.90; blue
 Item No.: 216-266 Ferrule; Sleeve for 2.5 mm ² / AWG 14; insulated; electro-tin plated; electrolytic copper; gastight crimped; acc. to DIN 46228, Part 4/09.90; blue			



1.3.3 Installation

1.3.3.1 Mounting accessories

 Item No.: 209-137 Mounting adapter; can be used as end stop; 6.5 mm wide; gray	 Item No.: 209-120 Mounting foot; can be snapped on terminal blocks with snap-in mounting foot; for mounting on relay-modules; 6.4 mm wide; gray
---	--





1.3.4 Insulation stop

1.3.4.1 Insulation stop

 Item No.: 2002-171 Insulation stop; 0.25 - 0.5 mm ² ; 5 pieces/strip; light gray	 Item No.: 2002-172 Insulation stop; 0.75 - 1 mm ² ; 5 pieces/strip; dark gray
--	---

1.3.5 Jumper

1.3.5.1 Jumper

 Item No.: 2002-400 Continuous jumper; 2-way; insulated; light gray	 Item No.: 2002-423/000-006 Continuous jumper; from 1 to 3; insulated; blue	 Item No.: 2002-423 Continuous jumper; from 1 to 3; insulated; light gray	 Item No.: 2002-423/000-005 Continuous jumper; from 1 to 3; insulated; red
 Item No.: 2002-424/000-006 Continuous jumper; from 1 to 4; insulated; blue	 Item No.: 2002-424 Continuous jumper; from 1 to 4; insulated; light gray	 Item No.: 2002-424/000-005 Continuous jumper; from 1 to 4; insulated; red	 Item No.: 2002-406/020-000 Delta jumper; insulated; light gray
 Item No.: 2002-410/000-006 Jumper; 10-way; insulated; blue	 Item No.: 2002-410 Jumper; 10-way; insulated; light gray	 Item No.: 2002-410/000-005 Jumper; 10-way; insulated; red	 Item No.: 2002-402/000-006 Jumper; 2-way; insulated; blue

1.3.5.1 Jumper

Item No.: 2002-402 Jumper; 2-way; insulated; light gray	Item No.: 2002-402/000-005 Jumper; 2-way; insulated; red	Item No.: 2002-403/000-006 Jumper; 3-way; insulated; blue	Item No.: 2002-403 Jumper; 3-way; insulated; light gray
Item No.: 2002-403/000-005 Jumper; 3-way; insulated; red	Item No.: 2002-404/000-006 Jumper; 4-way; insulated; blue	Item No.: 2002-404 Jumper; 4-way; insulated; light gray	Item No.: 2002-404/000-005 Jumper; 4-way; insulated; red
Item No.: 2002-405/000-006 Jumper; 5-way; insulated; blue	Item No.: 2002-405 Jumper; 5-way; insulated; light gray	Item No.: 2002-405/000-005 Jumper; 5-way; insulated; red	Item No.: 2002-406/000-006 Jumper; 6-way; insulated; blue
Item No.: 2002-406 Jumper; 6-way; insulated; light gray	Item No.: 2002-406/000-005 Jumper; 6-way; insulated; red	Item No.: 2002-407/000-006 Jumper; 7-way; insulated; blue	Item No.: 2002-407 Jumper; 7-way; insulated; light gray
Item No.: 2002-407/000-005 Jumper; 7-way; insulated; red	Item No.: 2002-408/000-006 Jumper; 8-way; insulated; blue	Item No.: 2002-408 Jumper; 8-way; insulated; light gray	Item No.: 2002-408/000-005 Jumper; 8-way; insulated; red
Item No.: 2002-409/000-006 Jumper; 9-way; insulated; blue	Item No.: 2002-409 Jumper; 9-way; insulated; light gray	Item No.: 2002-409/000-005 Jumper; 9-way; insulated; red	Item No.: 2002-440 Jumper; from 1 to 10; insulated; light gray
Item No.: 2002-433 Jumper; from 1 to 3; insulated; light gray	Item No.: 2002-434 Jumper; from 1 to 4; insulated; light gray	Item No.: 2002-435 Jumper; from 1 to 5; insulated; light gray	Item No.: 2002-436 Jumper; from 1 to 6; insulated; light gray
Item No.: 2002-437 Jumper; from 1 to 7; insulated; light gray	Item No.: 2002-438 Jumper; from 1 to 8; insulated; light gray	Item No.: 2002-439 Jumper; from 1 to 9; insulated; light gray	Item No.: 2002-480 Staggered jumper; 10-way; insulated; light gray
Item No.: 2002-481 Staggered jumper; 11-way; insulated; light gray	Item No.: 2002-482 Staggered jumper; 12-way; insulated; light gray	Item No.: 2002-473/011-000 Staggered jumper; 2-way; from 1 to 3; insulated; light gray	Item No.: 2002-472 Staggered jumper; 2-way; insulated; light gray
Item No.: 2002-473 Staggered jumper; 3-way; insulated; light gray	Item No.: 2002-475/011-000 Staggered jumper; 3-way; insulated; light gray	Item No.: 2002-474 Staggered jumper; 4-way; insulated; light gray	Item No.: 2002-475 Staggered jumper; 5-way; insulated; light gray
Item No.: 2002-476 Staggered jumper; 6-way; insulated; light gray	Item No.: 2002-477 Staggered jumper; 7-way; insulated; light gray	Item No.: 2002-478 Staggered jumper; 8-way; insulated; light gray	Item No.: 2002-479 Staggered jumper; 9-way; insulated; light gray
Item No.: 2002-477/011-000 Staggered jumper; insulated; light gray	Item No.: 2002-479/011-000 Staggered jumper; insulated; light gray	Item No.: 2002-481/011-000 Staggered jumper; insulated; light gray	Item No.: 2002-405/011-000 Star point jumper; 3-way; insulated; light gray
Item No.: 210-103 Wire commoning chain; insulated; black	Item No.: 210-123 Wire commoning chain; insulated; blue		

1.3.6 Marking

1.3.6.1 Group marker carrier



Item No.: 2009-191
Group marker carrier; gray

Item No.: 2009-192
Group marker carrier; gray

Item No.: 2009-193
Group marker carrier; gray

1.3.6.2 Marker

Item No.: 2009-145/000-006
Mini-WSB Inline; for Smart Printer; 1700 pieces on roll; stretchable 5 - 5.2 mm; plain; snap-on type; blue

Item No.: 2009-145/000-007
Mini-WSB Inline; for Smart Printer; 1700 pieces on roll; stretchable 5 - 5.2 mm; plain; snap-on type; gray

Item No.: 2009-145/000-023
Mini-WSB Inline; for Smart Printer; 1700 pieces on roll; stretchable 5 - 5.2 mm; plain; snap-on type; green

Item No.: 2009-145/000-012
Mini-WSB Inline; for Smart Printer; 1700 pieces on roll; stretchable 5 - 5.2 mm; plain; snap-on type; orange

Item No.: 2009-145/000-005
Mini-WSB Inline; for Smart Printer; 1700 pieces on roll; stretchable 5 - 5.2 mm; plain; snap-on type; red

Item No.: 2009-145/000-024
Mini-WSB Inline; for Smart Printer; 1700 pieces on roll; stretchable 5 - 5.2 mm; plain; snap-on type; violet

Item No.: 2009-145
Mini-WSB Inline; for Smart Printer; 1700 pieces on roll; stretchable 5 - 5.2 mm; plain; snap-on type; white

Item No.: 2009-145/000-002
Mini-WSB Inline; for Smart Printer; 1700 pieces on roll; stretchable 5 - 5.2 mm; plain; snap-on type; yellow



Item No.: 248-501/000-006
Mini-WSB marking card; as card; not stretchable; plain; snap-on type; blue

Item No.: 248-501/000-007
Mini-WSB marking card; as card; not stretchable; plain; snap-on type; gray

Item No.: 248-501/000-023
Mini-WSB marking card; as card; not stretchable; plain; snap-on type; green

Item No.: 248-501/000-017
Mini-WSB marking card; as card; not stretchable; plain; snap-on type; light green



Item No.: 248-501/000-012
Mini-WSB marking card; as card; not stretchable; plain; snap-on type; orange

Item No.: 248-501/000-005
Mini-WSB marking card; as card; not stretchable; plain; snap-on type; red

Item No.: 248-501/000-024
Mini-WSB marking card; as card; not stretchable; plain; snap-on type; violet

Item No.: 248-501
Mini-WSB marking card; as card; not stretchable; plain; snap-on type; white



Item No.: 248-501/000-002
Mini-WSB marking card; as card; not stretchable; plain; snap-on type; yellow

Item No.: 793-5501/000-006
WMB marking card; as card; for terminal block width 5 - 17.5 mm; stretchable 5 - 5.2 mm; plain; snap-on type; blue

Item No.: 793-5501/000-014
WMB marking card; as card; for terminal block width 5 - 17.5 mm; stretchable 5 - 5.2 mm; plain; snap-on type; brown

Item No.: 793-5501/000-007
WMB marking card; as card; for terminal block width 5 - 17.5 mm; stretchable 5 - 5.2 mm; plain; snap-on type; gray



Item No.: 793-5501/000-023
WMB marking card; as card; for terminal block width 5 - 17.5 mm; stretchable 5 - 5.2 mm; plain; snap-on type; green

Item No.: 793-5501/000-017
WMB marking card; as card; for terminal block width 5 - 17.5 mm; stretchable 5 - 5.2 mm; plain; snap-on type; light green

Item No.: 793-5501/000-012
WMB marking card; as card; for terminal block width 5 - 17.5 mm; stretchable 5 - 5.2 mm; plain; snap-on type; orange

Item No.: 793-5501/000-005
WMB marking card; as card; for terminal block width 5 - 17.5 mm; stretchable 5 - 5.2 mm; plain; snap-on type; red



Item No.: 793-5501/000-024
WMB marking card; as card; for terminal block width 5 - 17.5 mm; stretchable 5 - 5.2 mm; plain; snap-on type; violet

Item No.: 793-5501
WMB marking card; as card; for terminal block width 5 - 17.5 mm; stretchable 5 - 5.2 mm; plain; snap-on type; white

Item No.: 793-5501/000-002
WMB marking card; as card; for terminal block width 5 - 17.5 mm; stretchable 5 - 5.2 mm; plain; snap-on type; yellow

Item No.: 2009-115/000-006
WMB-Inline; for Smart Printer; 1500 pieces on roll; stretchable 5 - 5.2 mm; plain; snap-on type; blue



Item No.: 2009-115/000-007
WMB-Inline; for Smart Printer; 1500 pieces on roll; stretchable 5 - 5.2 mm; plain; snap-on type; gray

Item No.: 2009-115/000-023
WMB-Inline; for Smart Printer; 1500 pieces on roll; stretchable 5 - 5.2 mm; plain; snap-on type; green

Item No.: 2009-115/000-017
WMB-Inline; for Smart Printer; 1500 pieces on roll; stretchable 5 - 5.2 mm; plain; snap-on type; light green

Item No.: 2009-115/000-012
WMB-Inline; for Smart Printer; 1500 pieces on roll; stretchable 5 - 5.2 mm; plain; snap-on type; orange



Item No.: 2009-115/000-005
WMB-Inline; for Smart Printer; 1500 pieces on roll; stretchable 5 - 5.2 mm; plain; snap-on type; red

Item No.: 2009-115/000-024
WMB-Inline; for Smart Printer; 1500 pieces on roll; stretchable 5 - 5.2 mm; plain; snap-on type; violet

Item No.: 2009-115
WMB-Inline; for Smart Printer; 1500 pieces on roll; stretchable 5 - 5.2 mm; plain; snap-on type; white

Item No.: 2009-115/000-002
WMB-Inline; for Smart Printer; 1500 pieces on roll; stretchable 5 - 5.2 mm; plain; snap-on type; yellow

1.3.6.3 Marker carrier



Item No.: 2002-161
Adaptor; gray

Item No.: 2009-198
Adaptor; gray

1.3.6.4 Marking strip



Item No.: 2009-110
Marking strips; for Smart Printer; on reel; not stretchable; plain; snap-on type; white

1.3.7 Push-in type wire jumper

1.3.7.1 Jumper



Item No.: 2009-414
Push-in type wire jumper; 1.5 mm²; insulated; 110 mm long; black



Item No.: 2009-414/000-005
Push-in type wire jumper; 1.5 mm²; insulated; 110 mm long; black



Item No.: 2009-416
Push-in type wire jumper; 1.5 mm²; insulated; 250 mm long; black



Item No.: 2009-414/000-006
Push-in type wire jumper; insulated; 110 mm long; black



Item No.: 2009-412
Push-in type wire jumper; insulated; 60 mm long; black

1.3.8 Test and measurement

1.3.8.1 Testing accessories



Item No.: 2009-174
Test plug adapter; for 4 mm Ø test plugs; for testing TOPJOB®S rail-mounted terminal blocks; gray



Item No.: 210-136
Test plug; 2 mm Ø; with 500 mm cable; red



Item No.: 2009-182
Testing tap; for max. 2.5 mm²; tool-free connection for individual test wires 0.08 - 2.5 mm; gray



Item No.: 2002-649
TOPJOB®S L-type spacer module; modular; e.g., for bridging commoned terminal blocks; gray



Item No.: 2002-611
TOPJOB®S L-type test plug module; modular; 1-pole; 2,50 mm²; gray

1.3.9 Tool

1.3.9.1 Operating tool



Item No.: 210-658
Operating tool; Blade: 3.5 x 0.5 mm; with a partially insulated shaft; angled; short; multicoloured



Item No.: 210-720
Operating tool; Blade: 3.5 x 0.5 mm; with a partially insulated shaft; multicoloured

Installation Notes

Installation

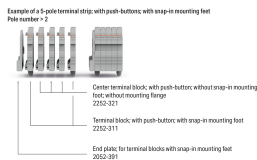

Conductor termination

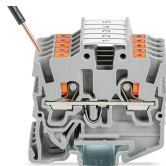

Insert solid conductors via push-in termination.



Insert ferruled conductors via push-in termination.



Insert fine-stranded conductors via operating tool.

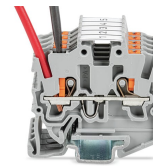

Remove all conductors via operating tool.

Commoning



Insert a delta jumper and push down until it hits the backstop (example shows terminal blocks with push-buttons).



Marking strip (2009-110) inserted in the marking slot with jumper symbols of the inserted jumper (delta jumper) (example shows terminal blocks with push-buttons)



Insert a star point jumper and push down until it hits the backstop (example shows terminal blocks with push-buttons).



Marking strip (2009-110) inserted in the marking slot with jumper symbols of the inserted jumper (2000-405/011-000 Delta Jumper) (example shows terminal blocks with push-buttons)

Testing



Testing with a 2 mm Ø 210-136 Test Plug (max. 42 V).

Installation

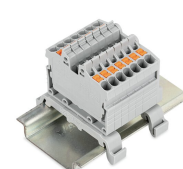

Marking



Snapping a marking strip into the marker slot.



Snapping a marking strip (2009-110) into a marker slot.