



ANT-DB1-WRT-MON-ccc

Dual-Band WiFi External Panel-Mount Antenna

The ANT-DB1-WRT-MON is a low-profile, panel-mount monopole antenna designed for superior performance in the 2.4 GHz and 5 GHz bands supporting WiFi 5 and WiFi 4 in the 2.5 GHz and 5 GHz ranges.

The ANT-DB1-WRT-MON antenna's compact size allows it to be mounted securely in enclosures requiring added security. The ANT-DB1-WRT-MON antenna's compact profile and rugged dome reduces the likelihood of accidental damage versus a whip antenna.

The antenna connects to the radio via SMA plug (male pin), RP-SMA plug (female socket) or MHF1/ U.FL-type plug (female socket) on 216 mm (8.5 in.) coaxial cable.

FEATURES

- Performance at 2.4 GHz to 2.5 GHz
 - VSWR: ≤ 2.2
 - Peak Gain: 2.1 dBi
 - Efficiency: 70%
- Performance at 5.150 GHz to 5.895 GHz
 - VSWR: ≤ 10.8
 - Peak Gain: 2.6 dBi
 - Efficiency: 28%
- Low-profile
 - Installed height: 27.0 mm (1.06 in)
- Mounts permanently with pressure sensitive adhesive ring and provided hex nut

APPLICATIONS

- WiFi/WLAN coverage
 - WiFi 5 (802.11ac)
 - WiFi 4 (802.11n)
 - 802.11b/g
- 2.4 GHz ISM applications
 - Bluetooth®
 - ZigBee®
- U-NII bands 1-8
- Cellular vehicle to everything (C-V2X)
- Internet of Things (IoT) devices
- Smart Home networking
 - Sensing and remote monitoring
 - Security

ORDERING INFORMATION

Part Number	Description
ANT-DB1-WRT-MON-RPS	Antenna with 216 mm (8.5 in) of RG-174 coaxial cable with an RP-SMA plug (female socket) connector
ANT-DB1-WRT-MON-SMA	Antenna with 216 mm (8.5 in) of RG-174 coaxial cable with an SMA plug (male pin) connector
ANT-DB1-WRT-MON-UFL	Antenna with 216 mm (8.5 in) of 1.32 mm coaxial cable with an MHF1/U.FL-type plug (female socket) connector

Available from Linx Technologies and select distributors and representatives.

TABLE 1. ELECTRICAL SPECIFICATIONS

ANT-DB1-WRT-MON	2.4 GHz	5.8 GHz	
Frequency Range	2.400 GHz to 2.500 GHz	5.150 GHz to 5.895 GHz	
VSWR (max)	2.2	10.8	
Peak Gain (dBi)	2.1	2.6	
Average Gain (dBi)	-1.6	-8.9	
Efficiency (%)	70	28	
Polarization	Linear	Radiation	Omnidirectional
Impedance	50 Ω	Max Power	5 W
Wavelength	1/4-wave	Electrical Type	Monopole

Electrical specifications and plots measured with a 102 mm x 102 mm (4.0 in x 4.0 in) reference ground plane.

TABLE 2. MECHANICAL SPECIFICATIONS

Parameter	
Operating Temp. Range	-40 °C to +85 °C
Weight	-RPS & -SMA = 19.0 g (0.67 oz), -UFL = 14.0 g (0.49 oz)
Connection	MHF1/U.FL-type plug (female socket) on 1.32 mm coax cable RP-SMA plug (female socket) on RG-174 coax cable SMA plug (male pin) on RG-174 coax cable
Coaxial Cable, minimum inside bend radius	RG-174: 10.2 mm (0.40 in), 1.32 mm: 6.0 mm (0.24 in)
Dimensions	Height: 27.0 mm (1.06 in), Diameter: 19.0 mm (0.75 in)

PACKAGING INFORMATION

The ANT-DB1-WRT-MON antenna is individually sealed in a clear plastic bag. Individual packages are packed in a bag of 100 pcs. Distribution channels may offer alternative packaging options.

PRODUCT DIMENSIONS

Figure 1 provides dimensions for the ANT-DB1-WRT-MON series antenna.

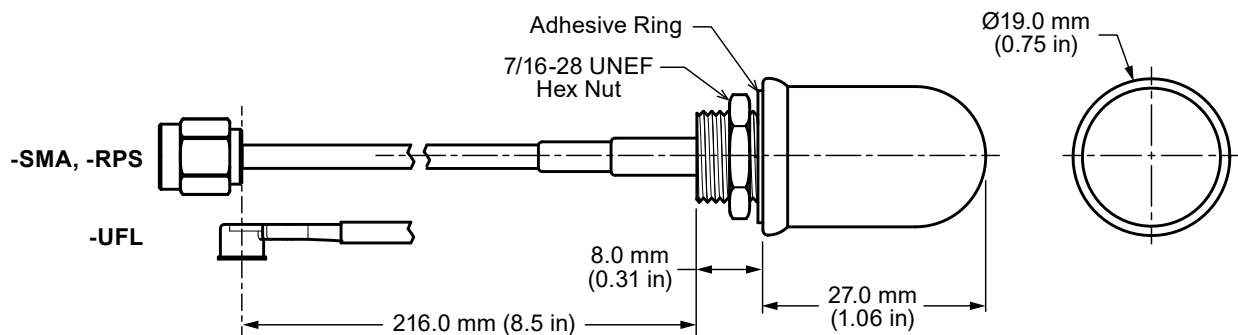

Figure 1. ANT-DB1-WRT-MON Antenna Dimensions

RECOMMENDED MOUNTING

The recommended enclosure mounting dimensions are shown in Figure 2. The ANT-DB1-WRT-MON series antenna is supplied with an integrated closed-cell pressure sensitive adhesive ring which helps seal enclosures against external elements. The adhesive ring has a protective plastic backing that must be removed prior to installation. A pull tab has been provided for easy removal of the protective backing. The antenna can be permanently mounted using the provided hex nut which should be tightened to 3.0 kgf/cm (5 in/lbs) max. The recommended maximum enclosure wall thickness is 3.18 mm (0.125 in).

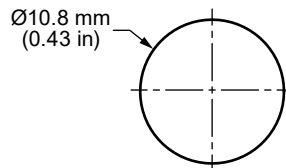

Figure 2. ANT-DB1-WRT-MON Series Antenna Recommended Enclosure Mounting Dimensions

GROUND PLANE

1/4-Wave monopole antennas require an associated ground plane counterpoise for proper operation. The size and location of the ground plane relative to the antenna will affect the overall performance of the antenna in the final design. When used in conjunction with a ground plane smaller than that used to tune the antenna, the center frequency typically will shift higher in frequency and the bandwidth will decrease. The proximity of other circuit elements and packaging near the antenna will also affect the final performance.

For further discussion and guidance on the importance of the ground plane counterpoise, please refer to Linx Application Note, AN-00501: Understanding Antenna Specifications and Operation.

ANTENNA ORIENTATION

The ANT-DB1-WRT-MON antenna is characterized with the antenna at the center of a 102 mm x 102 mm ground plane as shown in Figure 3.

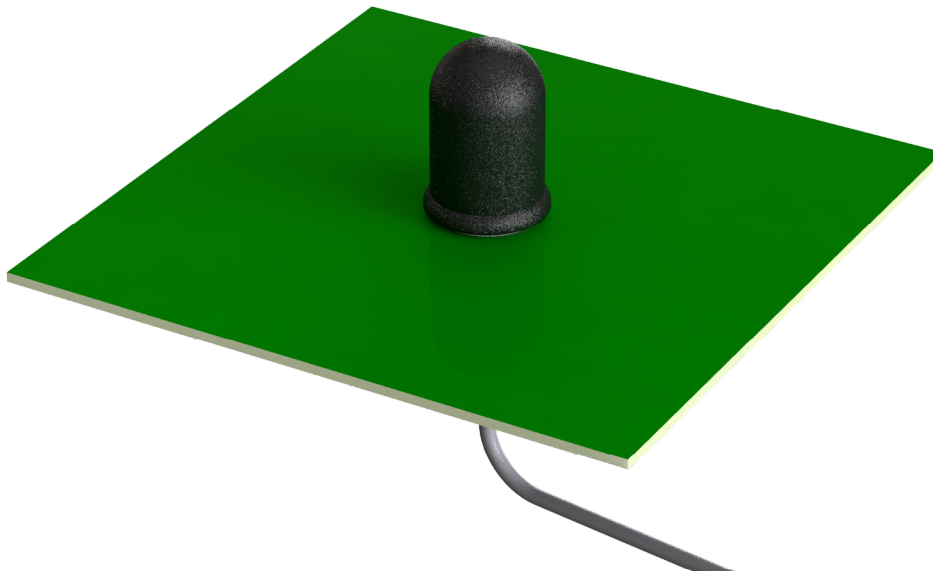

Figure 3. ANT-DB1-WRT-MON Test Orientation

VSWR

Figure 4 provides the voltage standing wave ratio (VSWR) across the antenna bandwidth. VSWR describes the power reflected from the antenna back to the radio. A lower VSWR value indicates better antenna performance at a given frequency. Reflected power is also shown on the right-side vertical axis as a gauge of the percentage of transmitter power reflected back from the antenna.

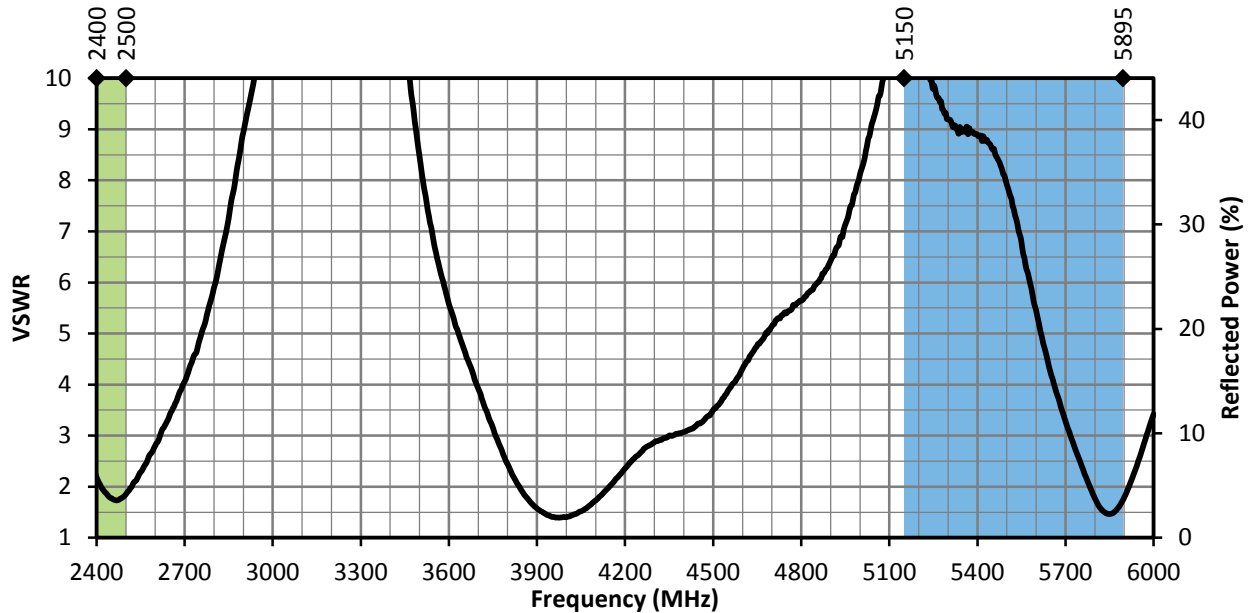

Figure 4. ANT-DB1-WRT-MON VSWR, with Frequency Band Highlights

RETURN LOSS

Return loss (Figure 5), represents the loss in power at the antenna due to reflected signals. Like VSWR, a lower return loss value indicates better antenna performance at a given frequency.

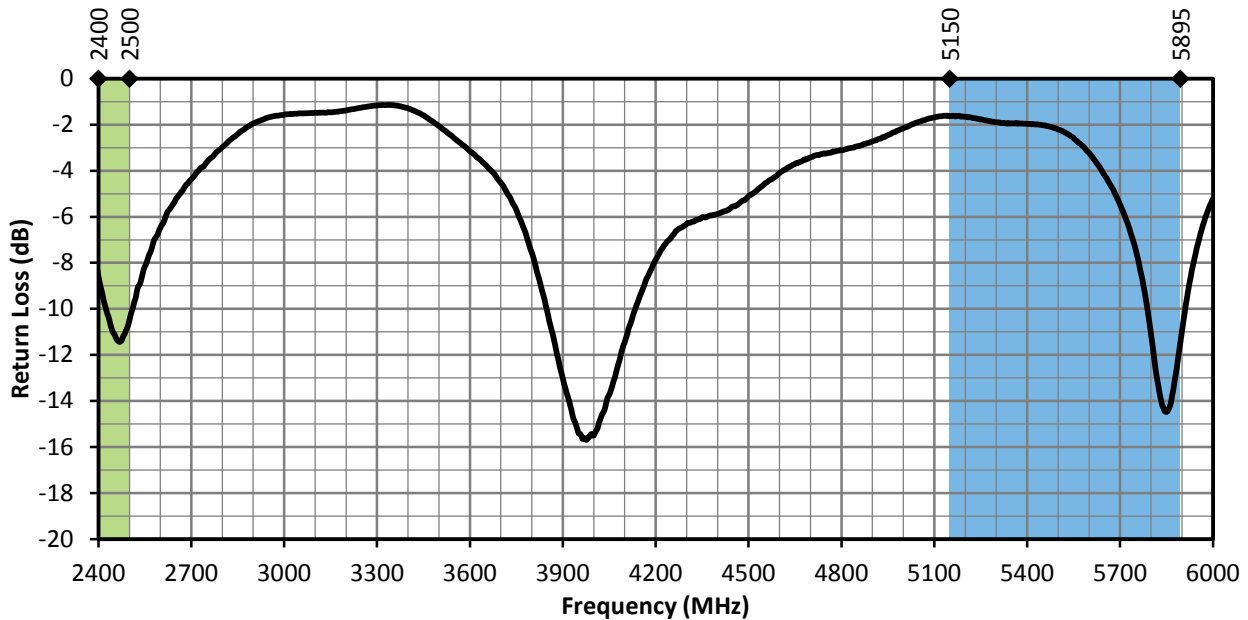

Figure 5. ANT-DB1-WRT-MON Return Loss, with Frequency Band Highlights

PEAK GAIN

The peak gain across the antenna bandwidth is shown in Figure 6. Peak gain represents the maximum antenna input power concentration across 3-dimensional space, and therefore peak performance at a given frequency, but does not consider any directionality in the gain pattern.

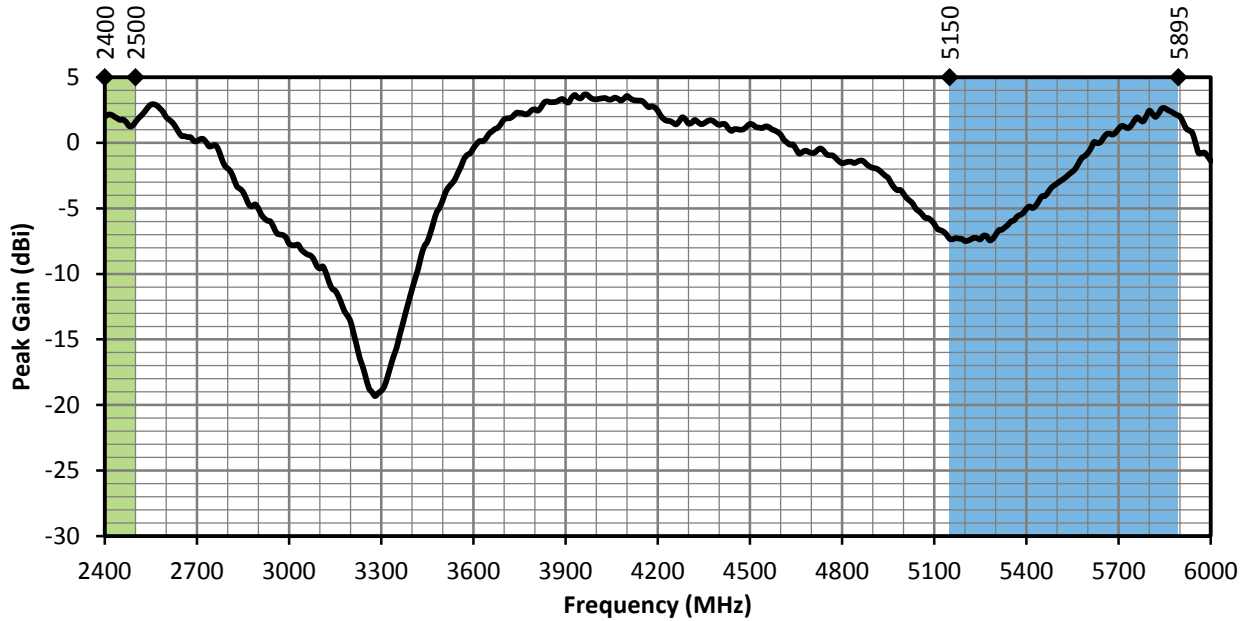

Figure 6. ANT-DB1-WRT-MON Peak Gain, with Frequency Band Highlights

AVERAGE GAIN

Average gain (Figure 6), is the average of all antenna gain in 3-dimensional space at each frequency, providing an indication of overall performance without expressing antenna directionality.

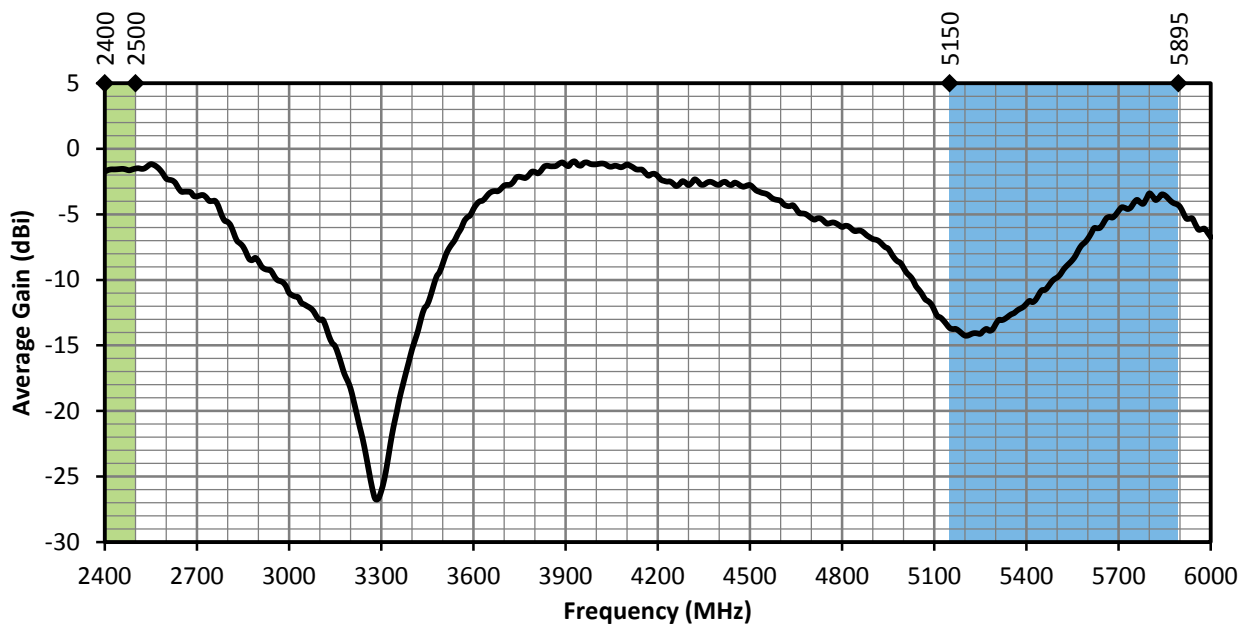

Figure 7. ANT-DB1-WRT-MON Antenna Average Gain, with Frequency Band Highlights

RADIATION EFFICIENCY

Radiation efficiency (Figure 8), shows the ratio of power delivered to the antenna relative to the power radiated at the antenna, expressed as a percentage, where a higher percentage indicates better performance at a given frequency.

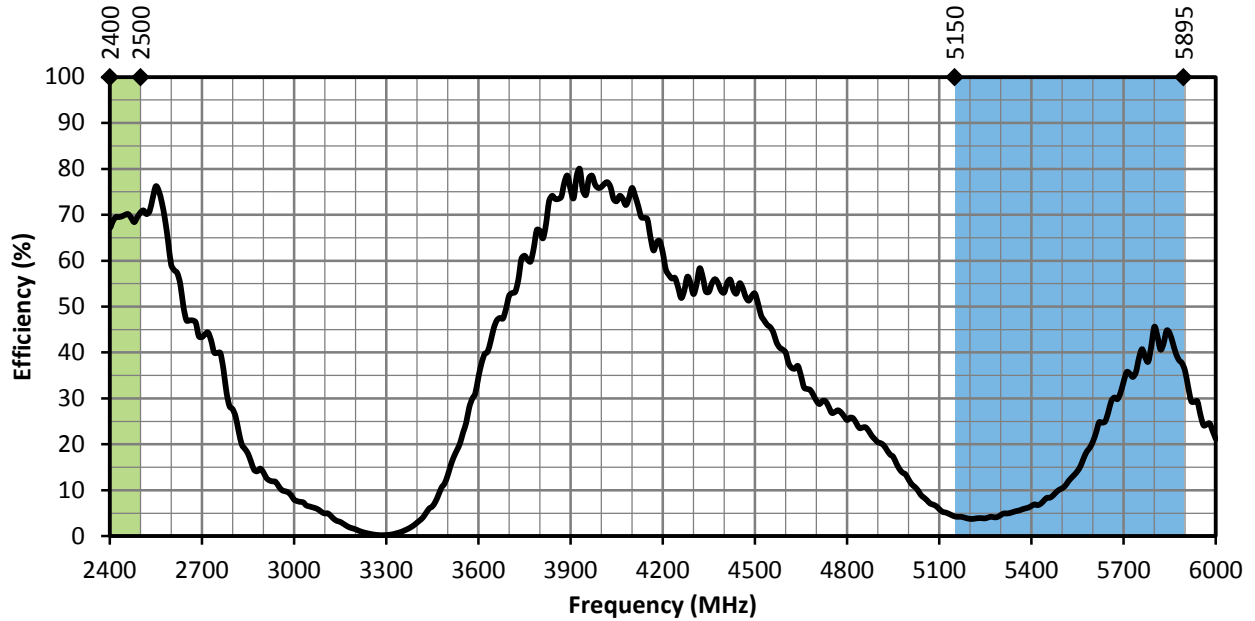
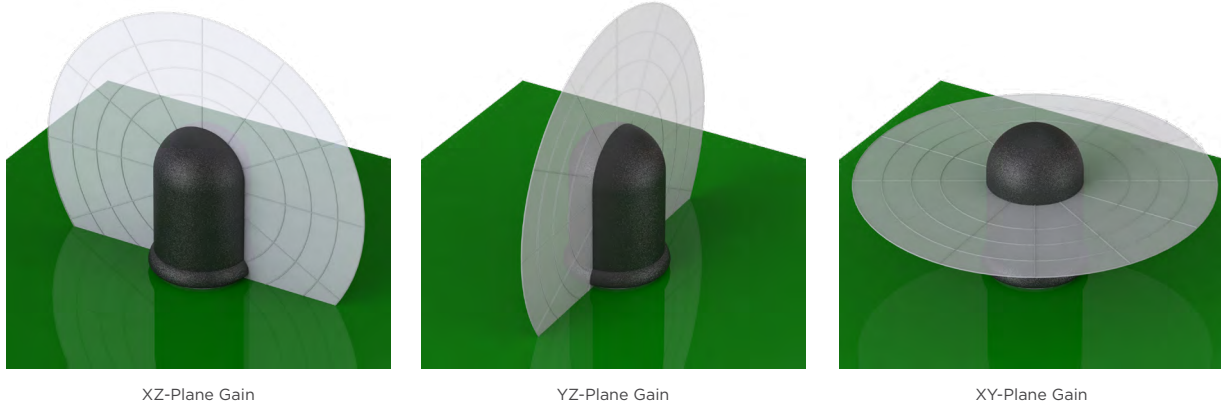

Figure 8. ANT-DB1-WRT-MON Antenna Radiation Efficiency, with Frequency Band Highlights

RADIATION PATTERNS

Radiation patterns provide information about the directionality and 3-dimensional gain performance of the antenna by plotting gain at specific frequencies in three orthogonal planes. Antenna radiation patterns are shown in Figure 9 using polar plots covering 360 degrees. The antenna graphic at the top of the page provides reference to the plane of the column of plots below it. Note: when viewed with typical PDF viewing software, zooming into radiation patterns is possible to reveal fine detail.



2400 MHz to 2500 MHz (2450 MHz)

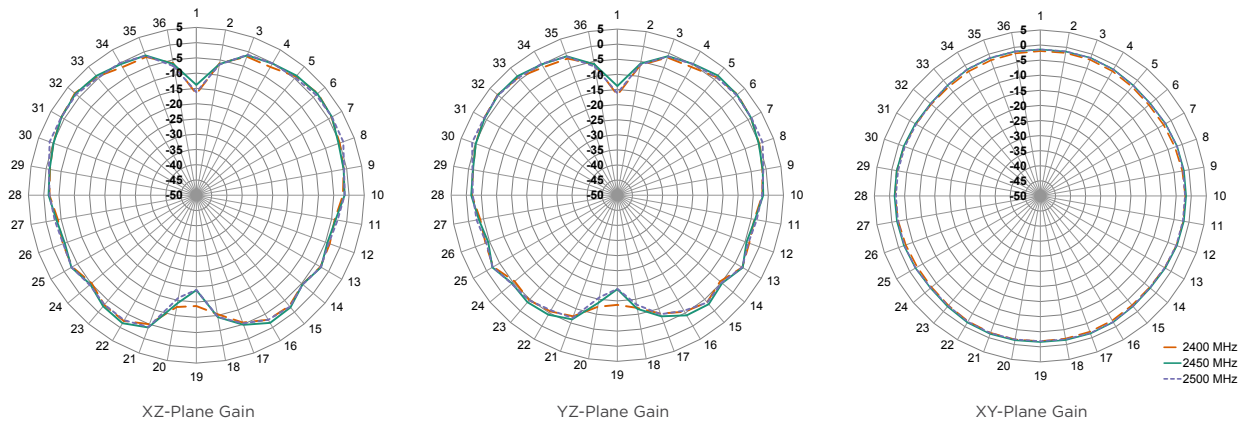

5150 MHz to 5895 MHz (5500 MHz)

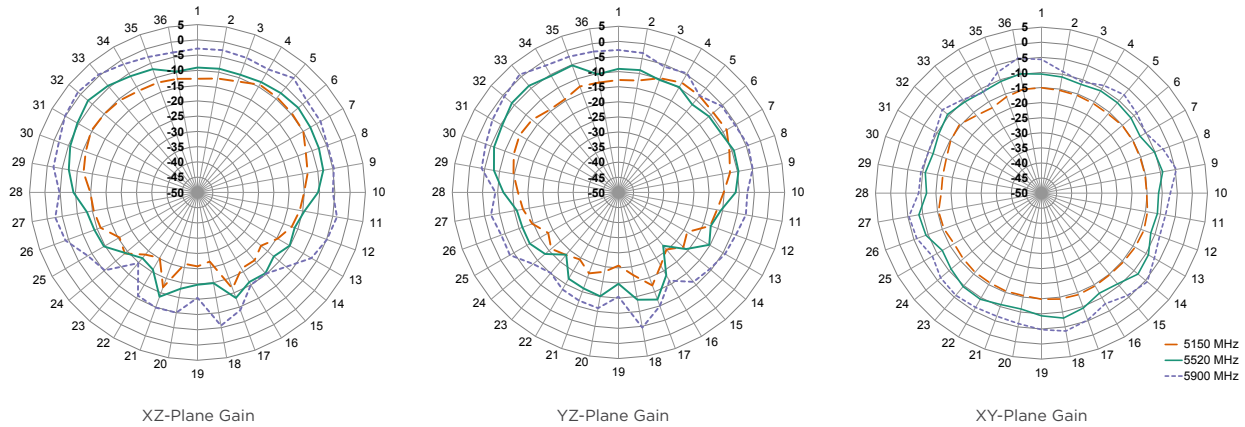

Figure 9. ANT-DB1-WRT-MON Radiation Patterns

TE TECHNICAL SUPPORT CENTER

USA:	+1 (800) 522-6752
Canada:	+1 (905) 475-6222
Mexico:	+52 (0) 55-1106-0800
Latin/S. America:	+54 (0) 11-4733-2200
Germany:	+49 (0) 6251-133-1999
UK:	+44 (0) 800-267666
France:	+33 (0) 1-3420-8686
Netherlands:	+31 (0) 73-6246-999
China:	+86 (0) 400-820-6015

te.com

TE Connectivity, TE, TE connectivity (logo), Linx and Linx Technologies are trademarks owned or licensed by the TE Connectivity Ltd. family of companies. All other logos, products and/or company names referred to herein might be trademarks of their respective owners.

The information given herein, including drawings, illustrations and schematics which are intended for illustration purposes only, is believed to be reliable. However, TE Connectivity makes no warranties as to its accuracy or completeness and disclaims any liability in connection with its use. TE Connectivity's obligations shall only be as set forth in TE Connectivity's Standard Terms and Conditions of Sale for this product and in no case will TE Connectivity be liable for any incidental, indirect or consequential damages arising out of the sale, resale, use or misuse of the product. Users of TE Connectivity products should make their own evaluation to determine the suitability of each such product for the specific application.

TE Connectivity warrants to the original end user customer of its products that its products are free from defects in material and workmanship. Subject to conditions and limitations TE Connectivity will, at its option, either repair or replace any part of its products that prove defective because of improper workmanship or materials. This limited warranty is in force for the useful lifetime of the original end product into which the TE Connectivity product is installed. Useful lifetime of the original end product may vary but is not warranted to exceed one (1) year from the original date of the end product purchase.

©2022 TE Connectivity. All Rights Reserved.

10/22 Original