



ANT-LTE-MON-SMA-L

Enhanced Low-Band LTE Connectorized Monopole Whip Antenna

The MON-L antenna is a member of Linx's LTE-MON family of compact rotatable hinged-whip antennas which offer optimized support for a wide range of cellular LTE and IoT applications.

The MON-L antenna provides excellent multiband cellular and cellular IoT performance. It offers better VSWR at the lower LTE frequency bands, including LTE Band 71 (617 MHz to 698 MHz), on a smaller ground plane than competitive products. This equates to better range in a smaller product design.

The hinged design allows for the antenna to be positioned for optimum performance and reduces the potential for damage from impact compared to a fixed whip design.

FEATURES

- Enhanced low-band coverage (LTE B71)
 - Efficiency: 73%
 - VSWR: ≤ 3.3
 - Peak Gain: 3.4 dBi
- Covers all common LTE/4G/3G/2G bands
- Hinged for optimum positioning
- Small, unobtrusive profile, 78.7 mm long
- Extended temperature range to 130 °C
- SMA plug (male pin)

APPLICATIONS

- Cellular IoT: LTE-M (Cat-M1) and NB-IoT
 - T-Mobile: band 71
 - AT&T: bands 12, 14, 17
 - Verizon: band 13
 - Europe: bands 8, 20
 - Latin America: bands 5, 28
 - Asia Pacific: bands 5, 8, 20, 28
- Worldwide LTE, UMTS and GSM
- Low-power, wide-area (LPWA) applications
 - LoRaWAN®
 - Sigfox®
- Citizens Broadband Radio Service (CBRS)
- ISM: Bluetooth® and ZigBee®
- FirstNet® Public Safety
- Internet of Things (IoT) devices
- Gateways

ORDERING INFORMATION

Part Number	Description
ANT-LTE-MON-SMA-L	Antenna with SMA plug (male pin)

Available from Linx Technologies and select distributors and representatives.

ELECTRICAL SPECIFICATIONS

Select Bands	Frequency Range	VSWR (max.)	Peak Gain (dBi)	Avg. Gain (dBi)	Efficiency (%)
LTE 71	617 MHz to 698 MHz	3.3	3.4	-1.5	73
LTE 12, 13, 14, 17, 26, 28, 29	698 MHz to 803 MHz	2.2	4.8	-0.7	90
LTE 5, 8, 20	791 MHz to 960 MHz	2.6	5.0	-1.1	90
LTE 1, 2, 3, 4, 25, 66	1710 MHz to 2200 MHz	3.2	3.9	-1.6	72
LTE 30, 40	2300 MHz to 2400 MHz	2.3	3.4	-1.2	77
LTE 7, 41	2496 MHz to 2690 MHz	1.9	4.1	-1.1	79
LTE 22, 42, 52, 43, 48, 49	3300 MHz to 3800 MHz	2.2	4.6	-2.4	64
ISM	2400 MHz to 2485 MHz	2.1	3.2	-1.4	74
Polarization	Linear	Impedance		50 Ω	
Radiation	Omnidirectional	Connection		SMA Plug (male pin)	
Max Power	10 W	Weight		10.0 g (0.35 oz)	
Wavelength	1/4-wave	Dimensions		78.7 mm (3.1 in)	
Electrical Type	Monopole	Operating Temperature		-40 °C to +130 °C	

Electrical specifications and plots measured with a 102 mm x 102 mm (4.0 in x 4.0 in) reference ground plane, edge straight orientation.

PRODUCT DIMENSIONS

Figure 1 provides dimensions of the MON-L. The antenna whip can be tilted 180 degrees, and has detents every 45 degrees enabling the antenna to be oriented in any direction. The rotating base allows for continuous positioning through 360 degrees even while installed.

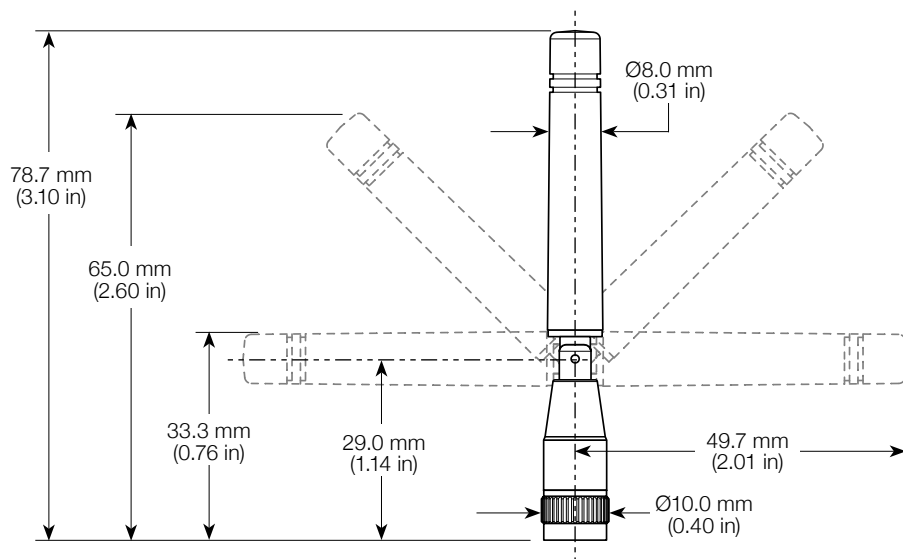
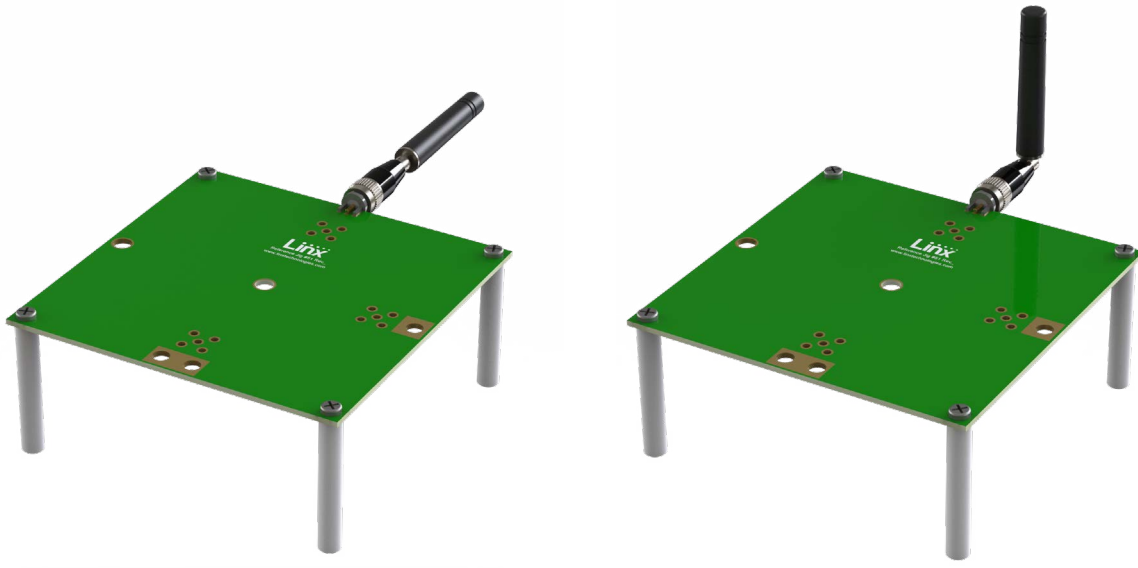

Figure 1: ANT-LTE-MON-SMA-L Antenna Dimensions

GROUND PLANE

1/4-Wave monopole antennas require an associated ground plane counterpoise for proper operation. The size and location of the ground plane relative to the antenna will affect the overall performance of the antenna in the final design. When used in conjunction with a ground plane smaller than that used to tune the antenna, the center frequency typically will shift higher in frequency and the bandwidth will decrease. The proximity of other circuit elements and packaging near the antenna will also affect the final performance.

For further discussion and guidance on the importance of the ground plane counterpoise, please refer to Linx Application Note, *AN-00501: Understanding Antenna Specifications and Operation*.



On edge of ground plane, straight

On edge of ground plane, bent 90 degrees

Figure 2. ANT-LTE-MON-SMA-L on Evaluation PCB

EDGE OF GROUND PLANE, STRAIGHT

The charts on the following pages represent data taken with the antenna oriented at the edge of the ground plane, straight (Edge-Straight), as shown in Figure 3.

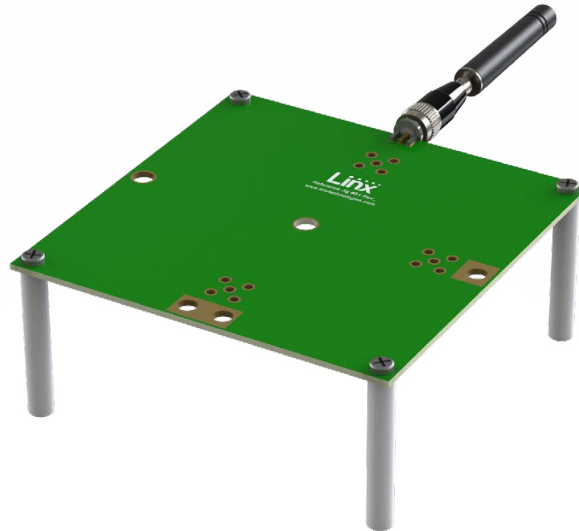

Figure 3. ANT-LTE-MON-SMA-L on Edge of Ground Plane, Straight (Edge-Straight)

VSWR

Figure 4 provides the voltage standing wave ratio (VSWR) across the antenna bandwidth. VSWR describes the power reflected from the antenna back to the radio. A lower VSWR value indicates better antenna performance at a given frequency. Reflected power is also shown on the right-side vertical axis as a gauge of the percentage of transmitter power reflected back from the antenna.

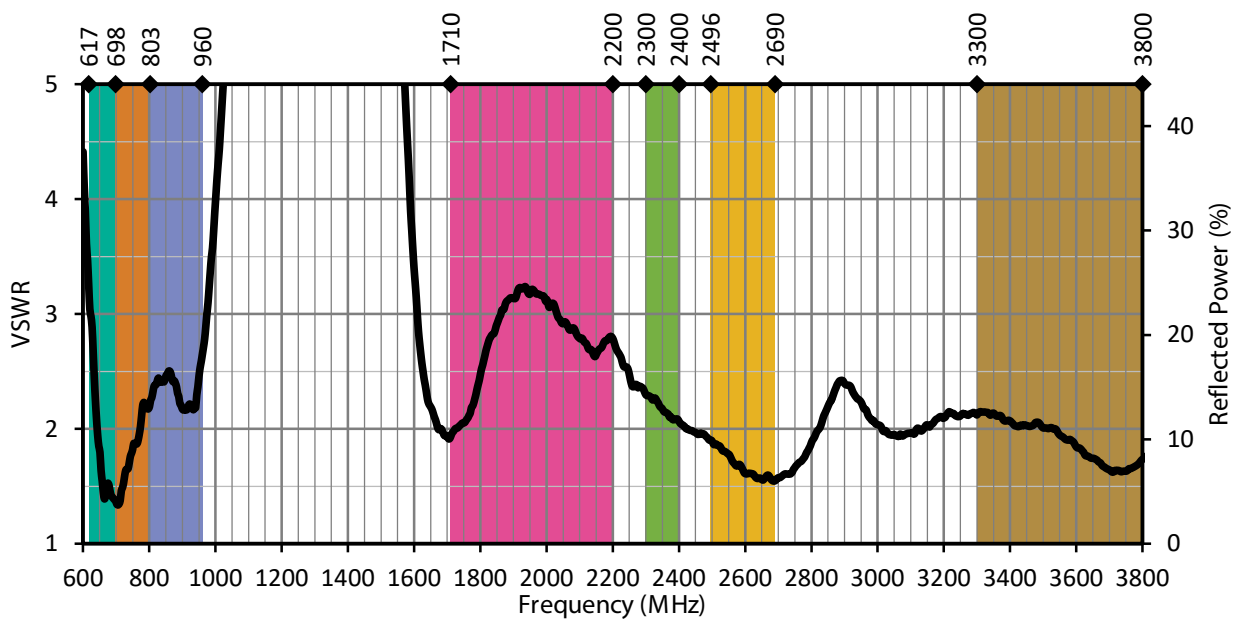

Figure 4. MON-L VSWR, Edge-Straight, with Frequency Band Highlights

RETURN LOSS

Return loss (Figure 5), represents the loss in power at the antenna due to reflected signals. Like VSWR, a lower return loss value indicates better antenna performance at a given frequency.

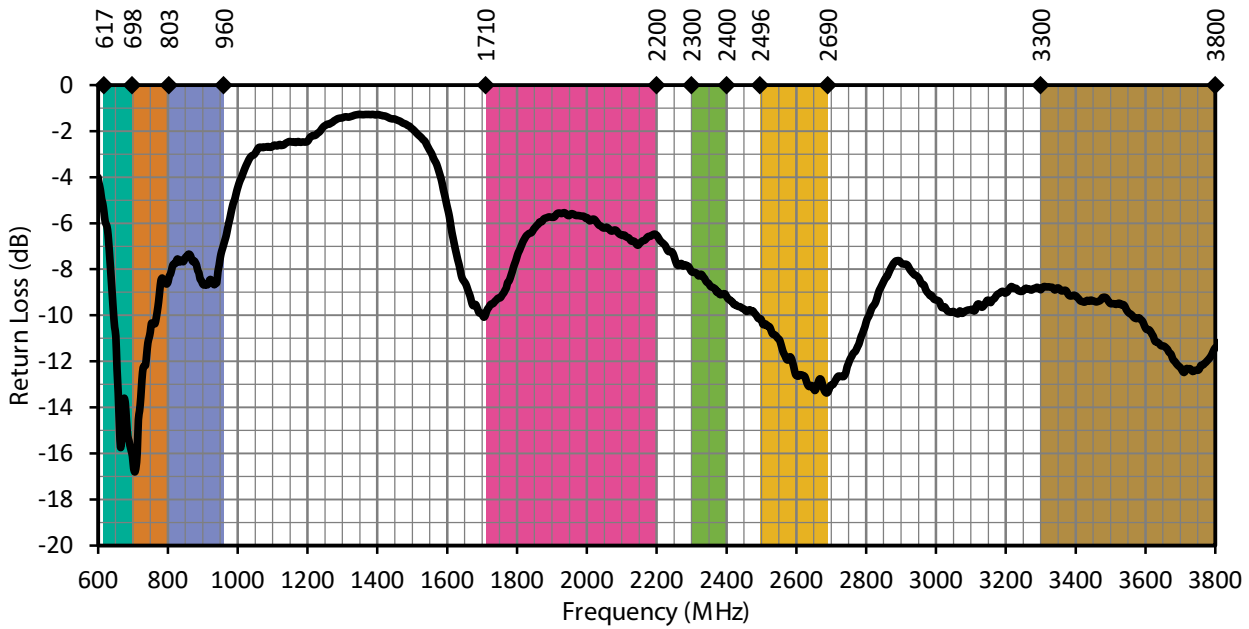

Figure 5. MON-L Return Loss, Edge-Straight, with Frequency Band Highlights

PEAK GAIN

The peak gain across the antenna bandwidth is shown in Figure 6. Peak gain represents the maximum antenna input power concentration across 3-dimensional space, and therefore peak performance at a given frequency, but does not consider any directionality in the gain pattern.

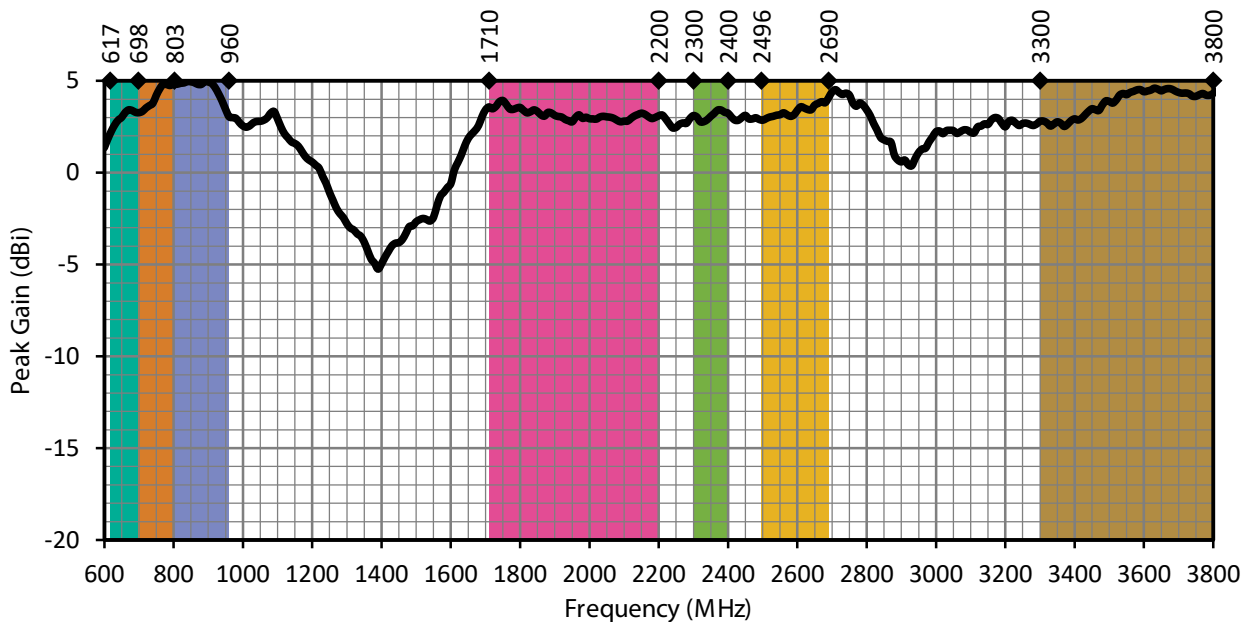

Figure 6. MON-L Peak Gain, Edge-Straight, with Frequency Band Highlights

AVERAGE GAIN

Average gain (Figure 7), is the average of all antenna gain in 3-dimensional space at each frequency, providing an indication of overall performance without expressing antenna directionality.

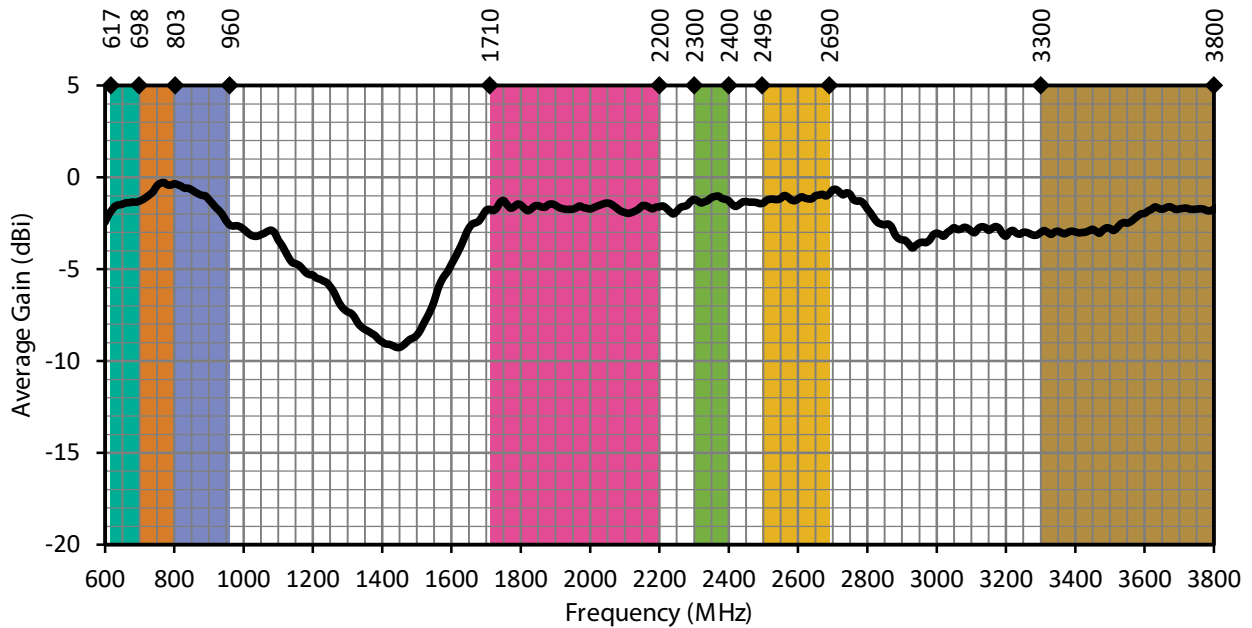

Figure 7. MON-L Antenna Average Gain, Edge-Straight, with Frequency Band Highlights

RADIATION EFFICIENCY

Radiation efficiency (Figure 8), shows the ratio of power delivered to the antenna relative to the power radiated at the antenna, expressed as a percentage, where a higher percentage indicates better performance at a given frequency.

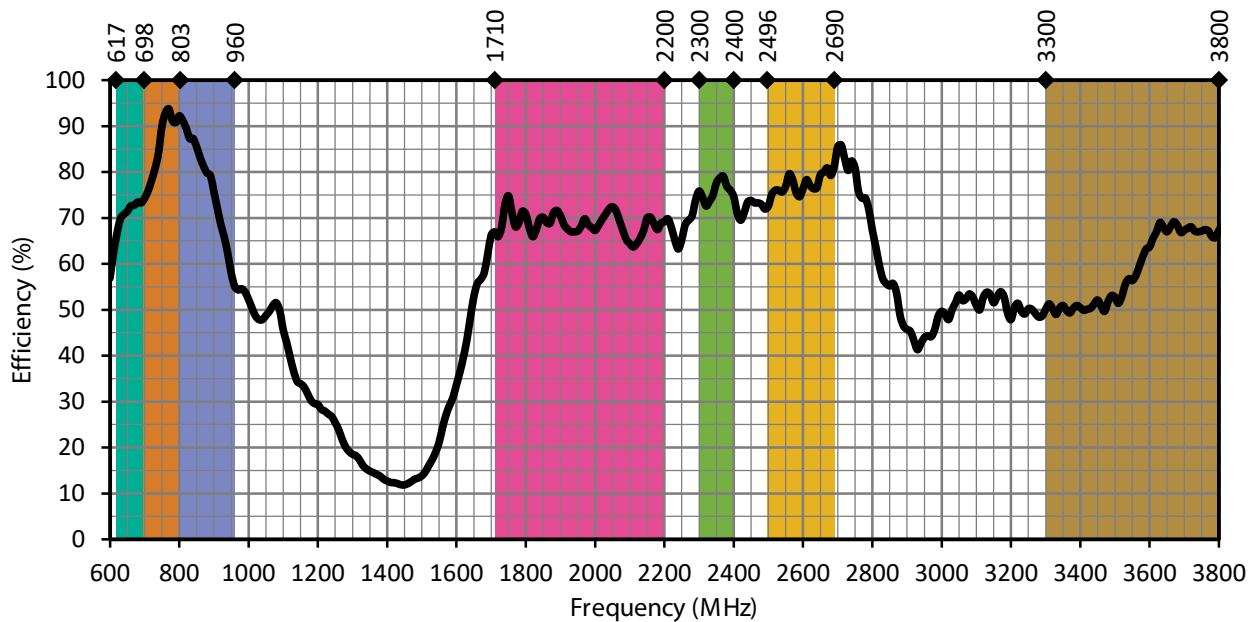
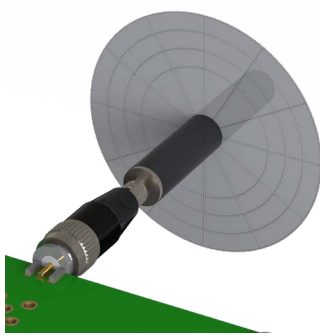

Figure 8. MON-L Antenna Radiation Efficiency, Edge-Straight, with Frequency Band Highlights

RADIATION PATTERNS

Radiation patterns provide information about the directionality and 3-dimensional gain performance of the antenna by plotting gain at specific frequencies in three orthogonal planes. Antenna radiation patterns for an edge straight orientation are shown in Figure 9 using polar plots covering 360 degrees. The antenna graphic at the top of the page provides reference to the plane of the column of plots below it. Note: when viewed with typical PDF viewing software, zooming into radiation patterns is possible to reveal fine detail.

RADIATION PATTERNS - EDGE OF GROUND PLANE, STRAIGHT



XZ-Plane Gain



YZ-Plane Gain

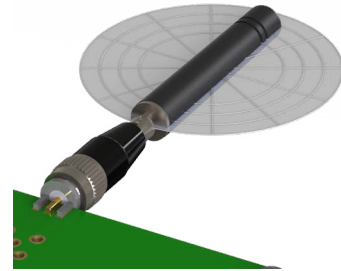

XY-Plane Gain

610 MHz TO 700 MHz (660 MHz)

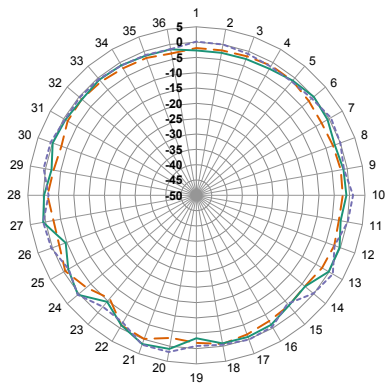

XZ-Plane Gain

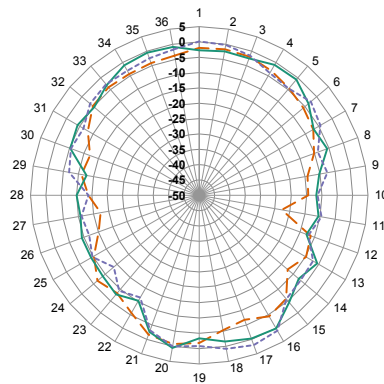

YZ-Plane Gain

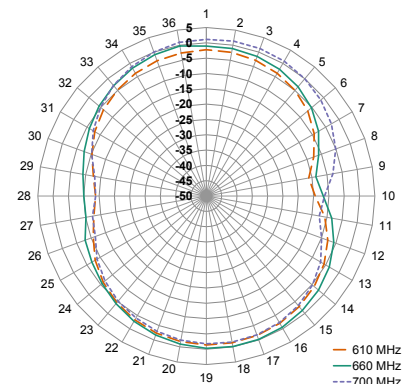

XY-Plane Gain

700 MHz TO 800 MHz (750 MHz)

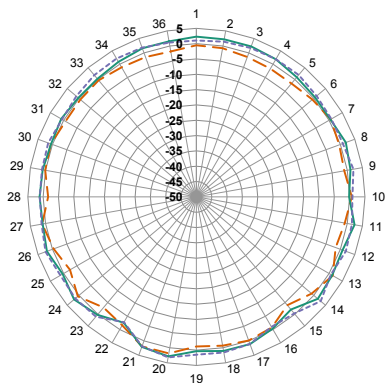

XZ-Plane Gain

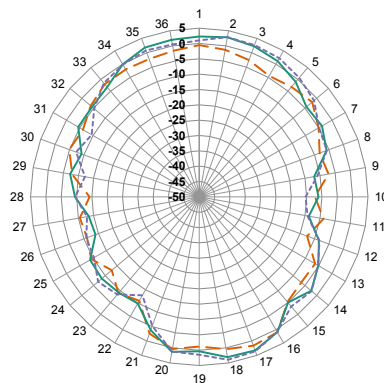

YZ-Plane Gain

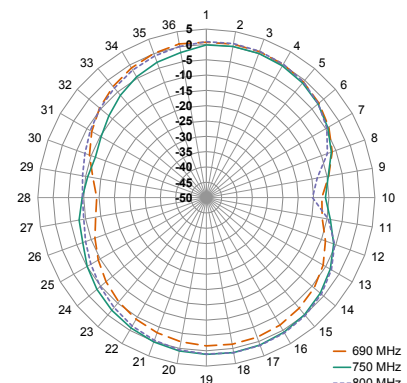

XY-Plane Gain

RADIATION PATTERNS - EDGE OF GROUND PLANE, STRAIGHT

790 MHz TO 960 MHz (870 MHz)

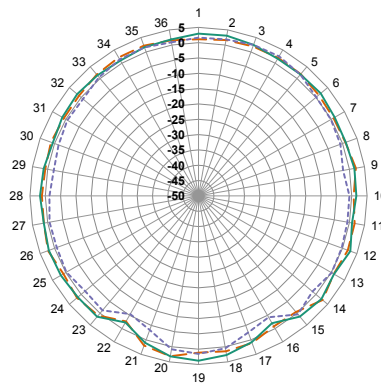

XZ-Plane Gain

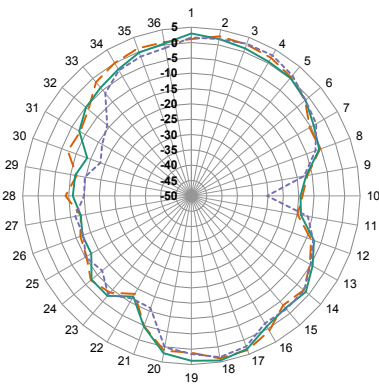

YZ-Plane Gain

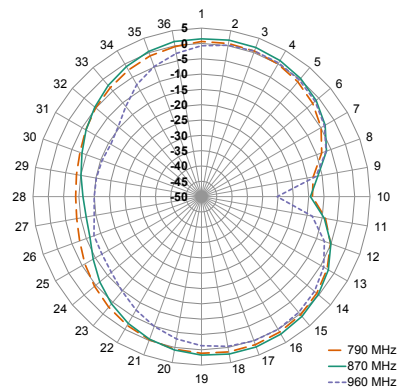

XY-Plane Gain

— 790 MHz
— 870 MHz
- - 960 MHz

1710 MHz TO 2200 MHz (1940 MHz)

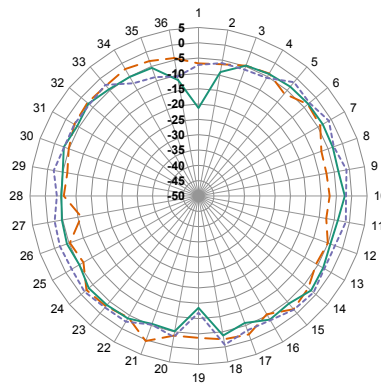

XZ-Plane Gain

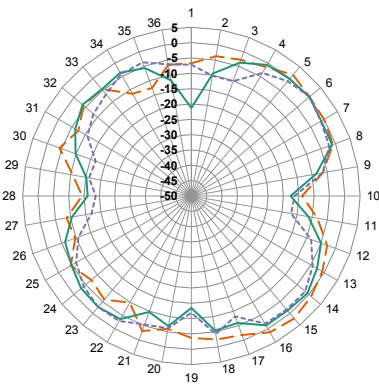

YZ-Plane Gain

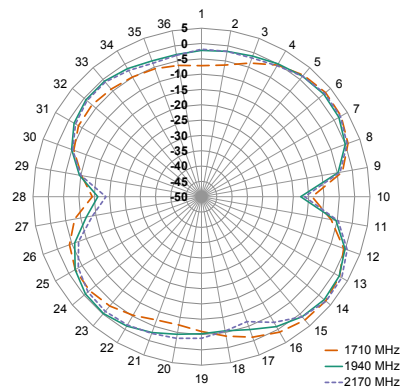

XY-Plane Gain

— 1710 MHz
— 1940 MHz
- - 2170 MHz

2300 MHz TO 2400 MHz (2350 MHz)

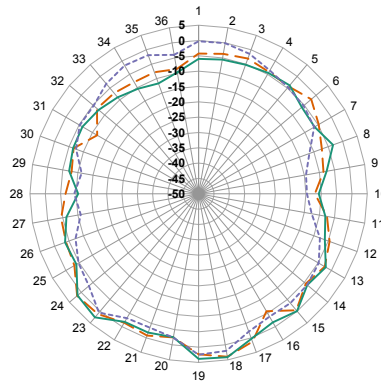

XZ-Plane Gain

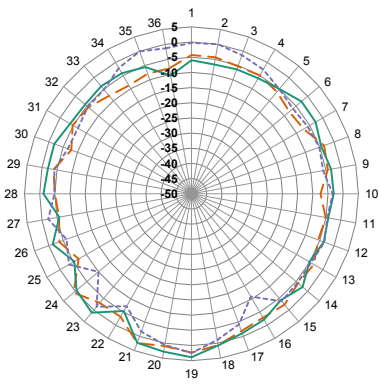

YZ-Plane Gain

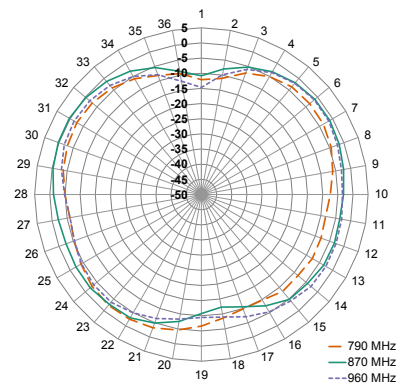

XY-Plane Gain

— 790 MHz
— 870 MHz
- - 960 MHz

RADIATION PATTERNS - EDGE OF GROUND PLANE, STRAIGHT

2496 MHz TO 2690 MHz (2450 MHz)

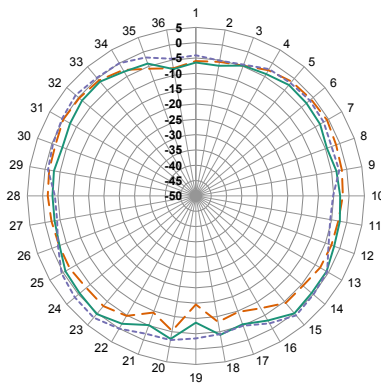

XZ-Plane Gain

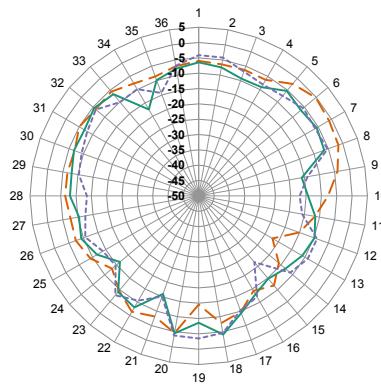

YZ-Plane Gain

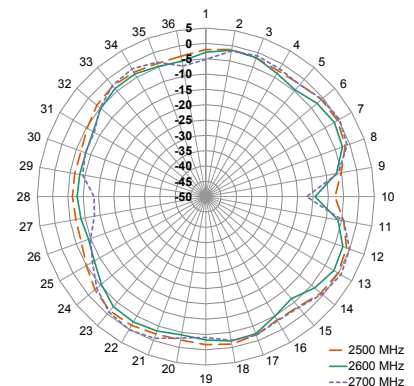

XY-Plane Gain

— 2500 MHz
— 2600 MHz
- - 2700 MHz

3300 MHz TO 3800 MHz (3550 MHz)

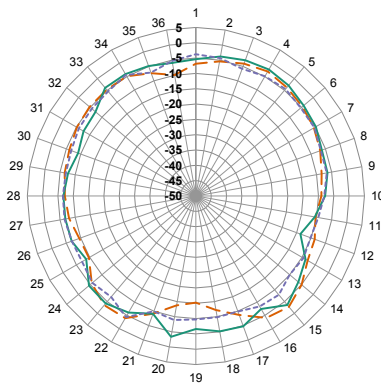

XZ-Plane Gain

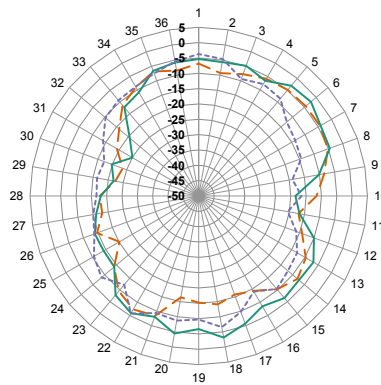

YZ-Plane Gain

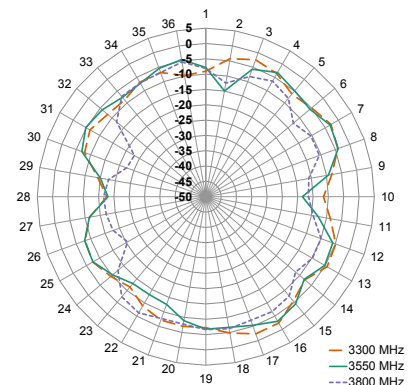

XY-Plane Gain

— 3300 MHz
— 3550 MHz
- - 3800 MHz

2400 MHz TO 2500 MHz (2450 MHz)

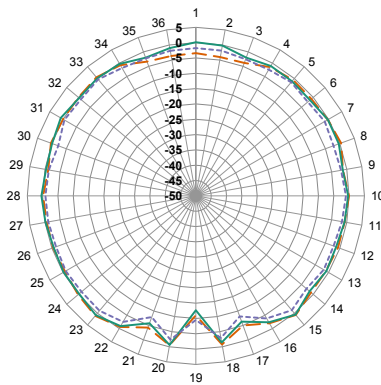

XZ-Plane Gain

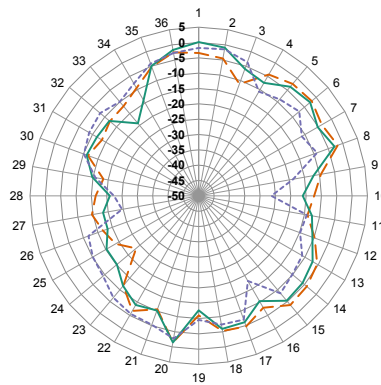

YZ-Plane Gain

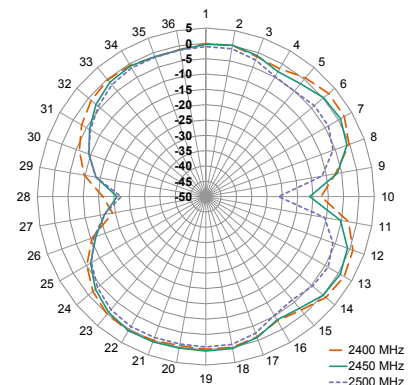

XY-Plane Gain

— 2400 MHz
— 2450 MHz
- - 2500 MHz

EDGE OF GROUND PLANE, BENT 90 DEGREES

The charts on the following pages represent data taken with the antenna oriented at the edge of the ground plane, bent 90 degrees (Edge-Bent), as shown in Figure 10.

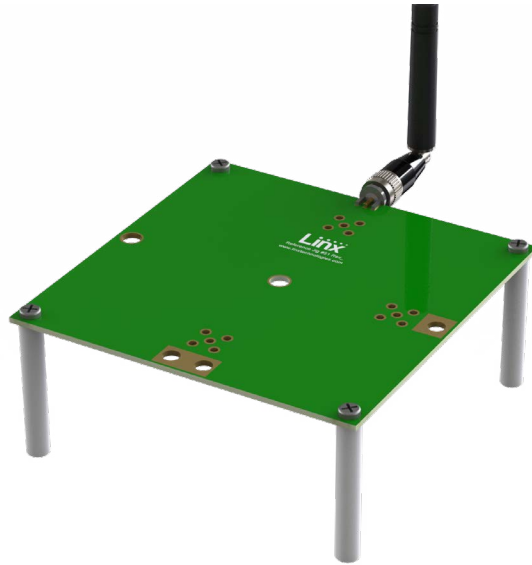

Figure 10. ANT-LTE-MON-SMA-L on Edge of Ground Plane, Bent 90 Degrees (Edge-Bent)

VSWR

Figure 11 provides the voltage standing wave ratio (VSWR) across the antenna bandwidth. VSWR describes the power reflected from the antenna back to the radio. A lower VSWR value indicates better antenna performance at a given frequency. Reflected power is also shown on the right-side vertical axis as a gauge of the percentage of transmitter power reflected back from the antenna.

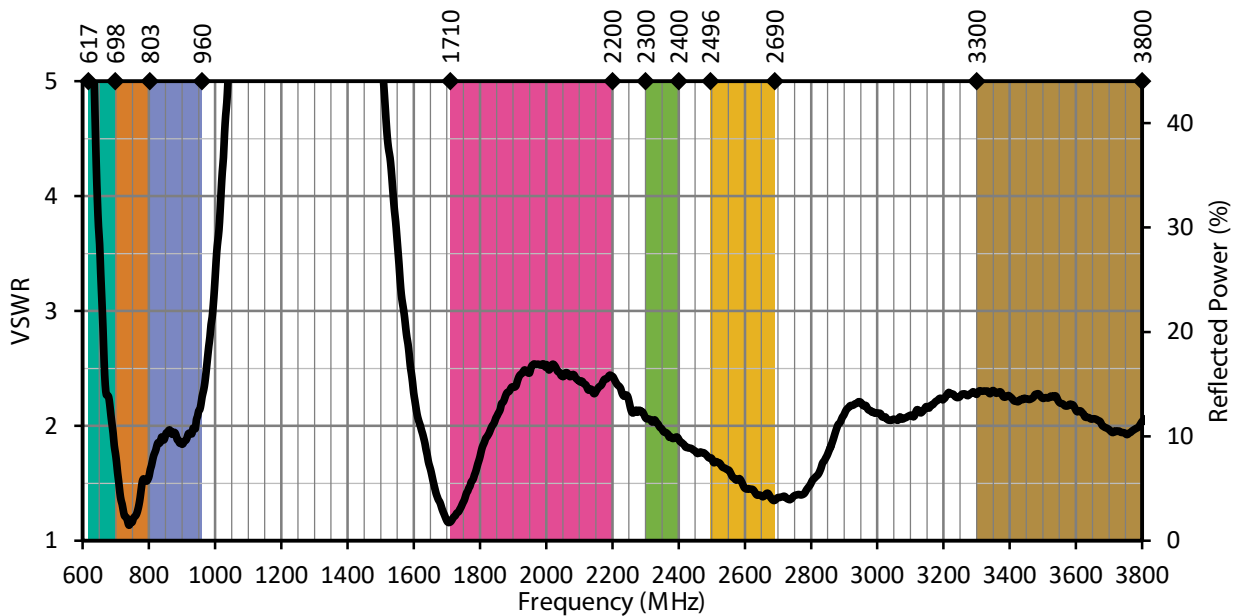

Figure 11. MON-L VSWR, Edge-Bent, with Frequency Band Highlights

RETURN LOSS

Return loss (Figure 12), represents the loss in power at the antenna due to reflected signals. Like VSWR, a lower return loss value indicates better antenna performance at a given frequency.

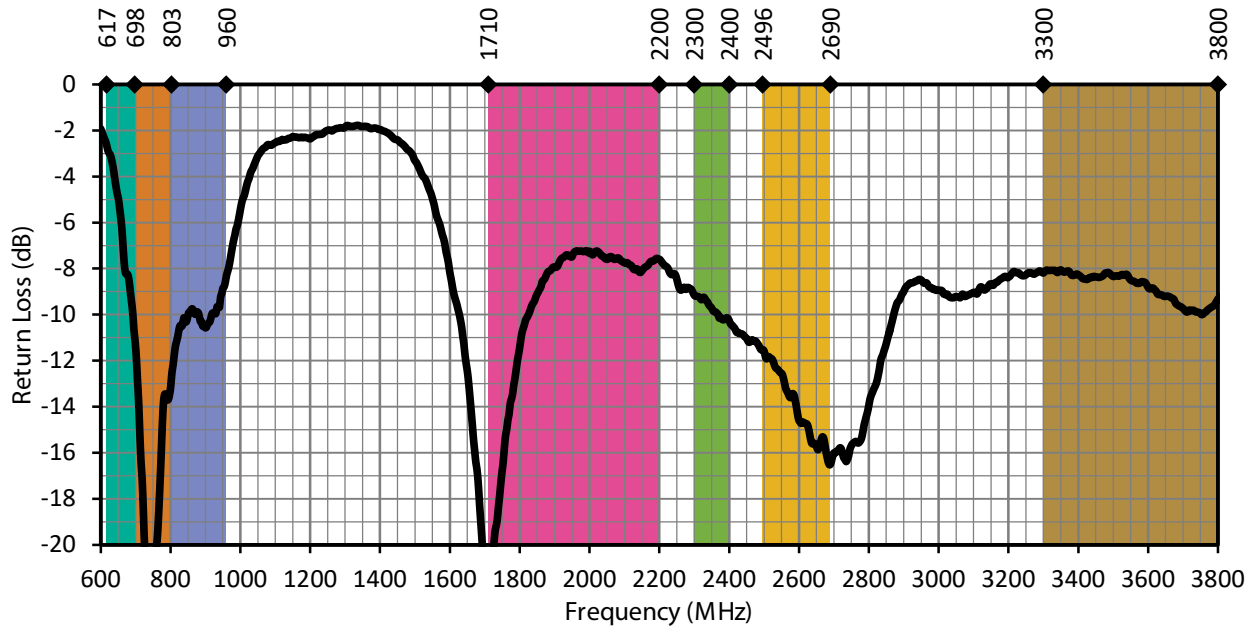

Figure 12. MON-L Return Loss, Edge-Bent, with Frequency Band Highlights

PEAK GAIN

The peak gain across the antenna bandwidth is shown in Figure 13. Peak gain represents the maximum antenna input power concentration across 3-dimensional space, and therefore peak performance at a given frequency, but does not consider any directionality in the gain pattern.

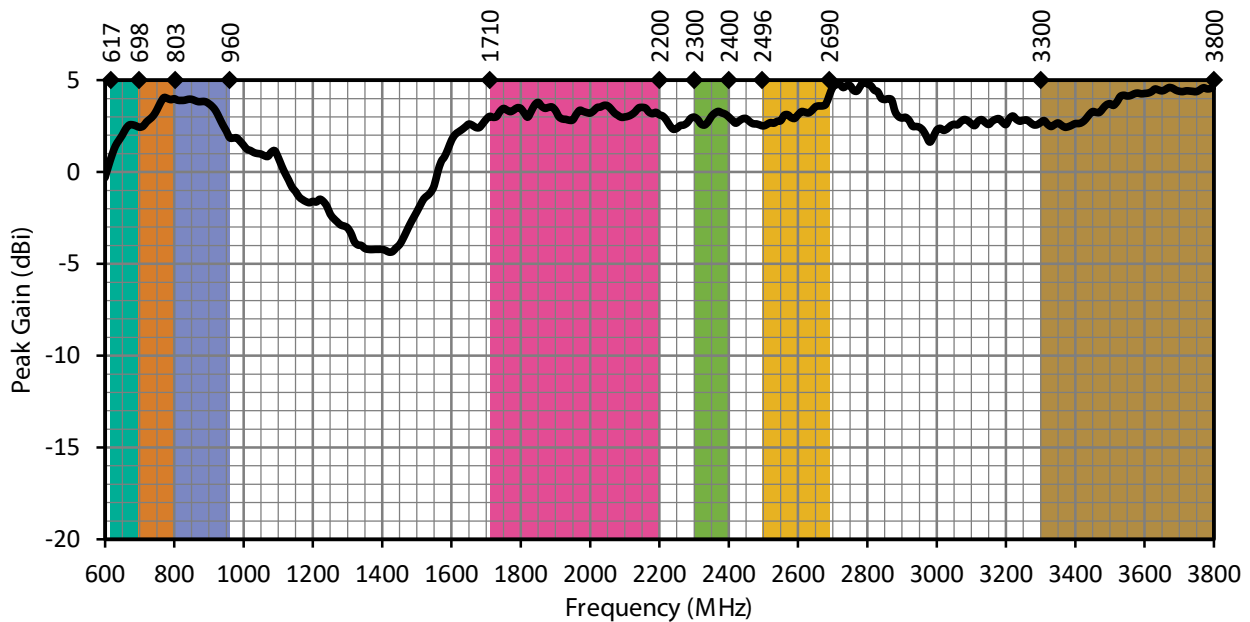

Figure 13. MON-L Peak Gain, Edge-Bent, with Frequency Band Highlights

AVERAGE GAIN

Average gain (Figure 14), is the average of all antenna gain in 3-dimensional space at each frequency, providing an indication of overall performance without expressing antenna directionality.

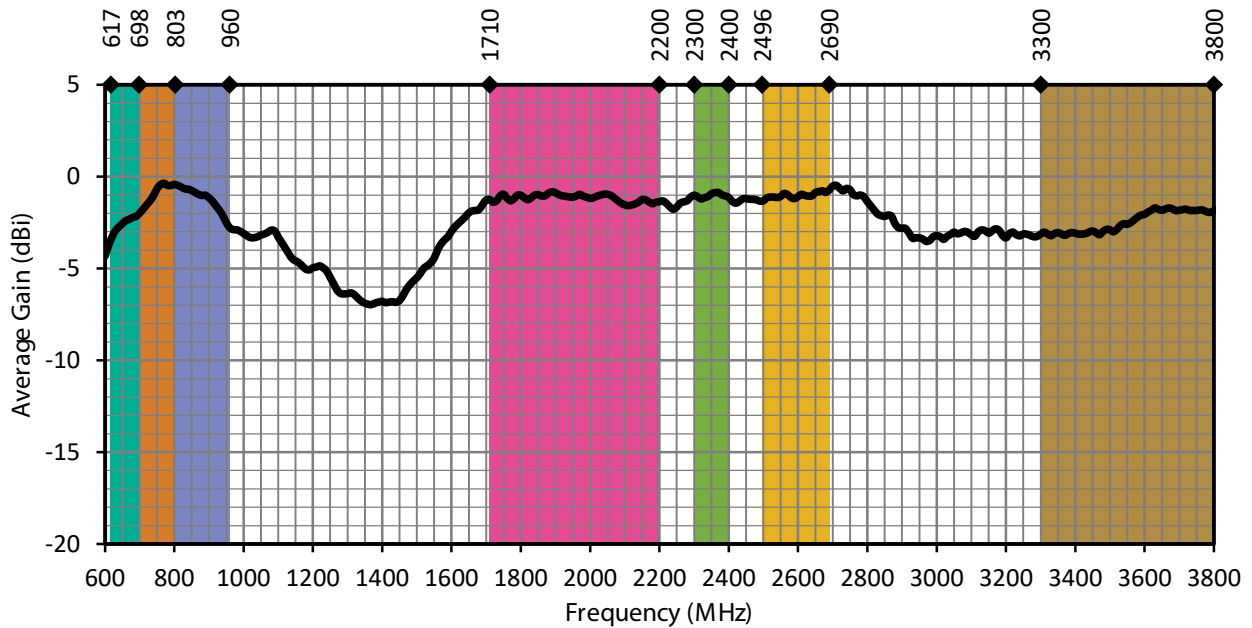

Figure 14. MON-L Antenna Average Gain, Edge-Bent, with Frequency Band Highlights

RADIATION EFFICIENCY

Radiation efficiency (Figure 15), shows the ratio of power delivered to the antenna relative to the power radiated at the antenna, expressed as a percentage, where a higher percentage indicates better performance at a given frequency.

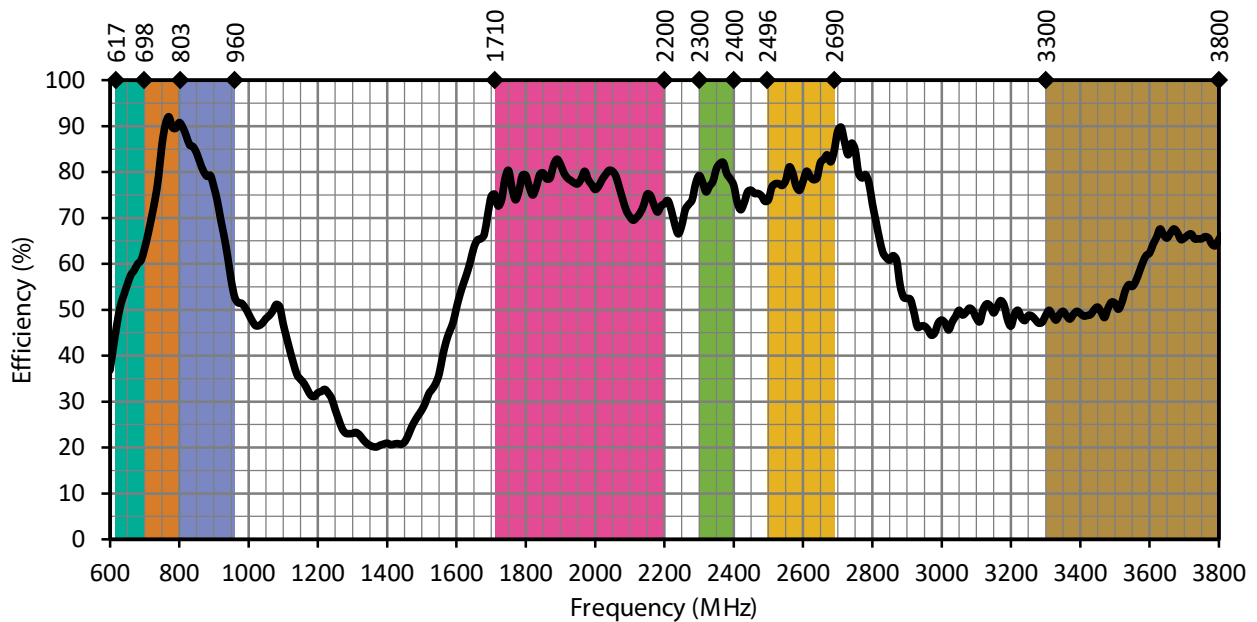

Figure 15. MON-L Antenna Radiation Efficiency, Edge-Bent, with Frequency Band Highlights

RADIATION PATTERNS

Radiation patterns provide information about the directionality and 3-dimensional gain performance of the antenna by plotting gain at specific frequencies in three orthogonal planes. Antenna radiation patterns for a bent 90 degree orientation are shown in Figure 16 using polar plots covering 360 degrees. The antenna graphic at the top of the page provides reference to the plane of the column of plots below it. Note: when viewed with typical PDF viewing software, zooming into radiation patterns is possible to reveal fine detail.

RADIATION PATTERNS - EDGE OF GROUND PLANE, BENT 90 DEGREES



XZ-Plane Gain



YZ-Plane Gain



XY-Plane Gain

610 MHz TO 700 MHz (660 MHz)

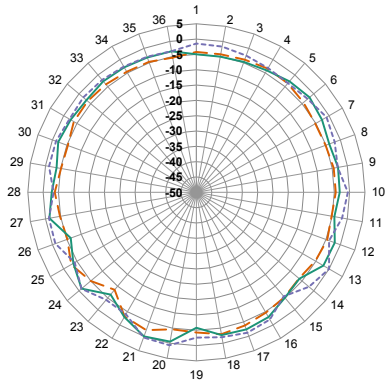

XZ-Plane Gain

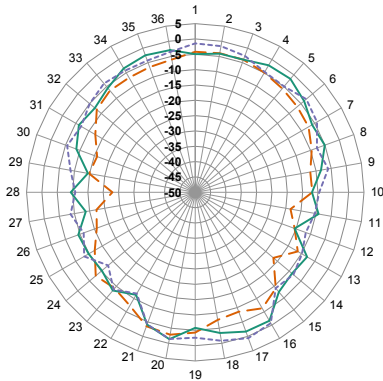

YZ-Plane Gain

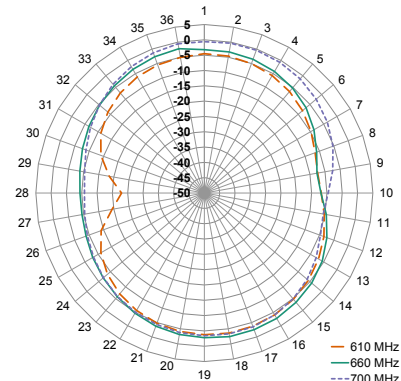

XY-Plane Gain

— 610 MHz
— 660 MHz
- - 700 MHz

700 MHz TO 800 MHz (750 MHz)

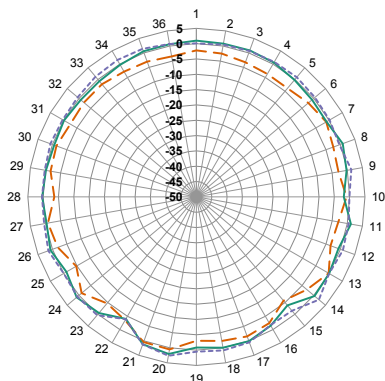

XZ-Plane Gain

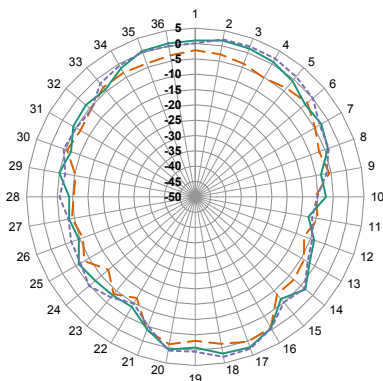

YZ-Plane Gain

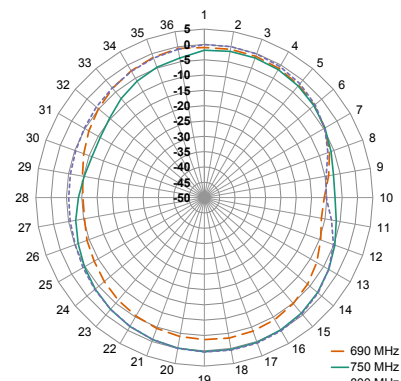

XY-Plane Gain

— 690 MHz
— 750 MHz
- - 800 MHz

RADIATION PATTERNS - EDGE OF GROUND PLANE, BENT 90 DEGREES

790 MHz TO 960 MHz (870 MHz)

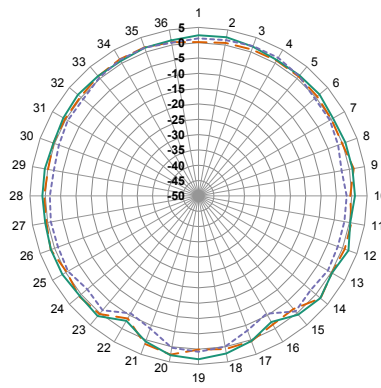

XZ-Plane Gain

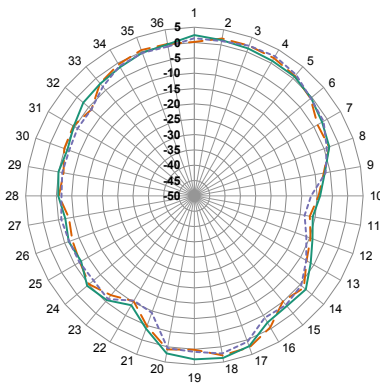

YZ-Plane Gain

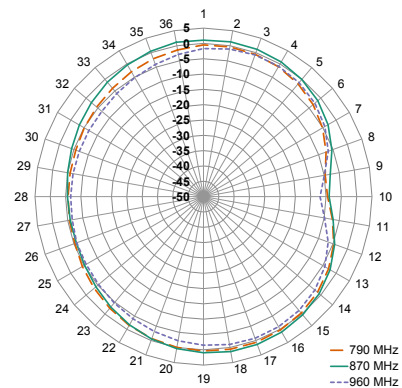

XY-Plane Gain

— 790 MHz
— 870 MHz
- - 960 MHz

1710 MHz TO 2200 MHz (1940 MHz)

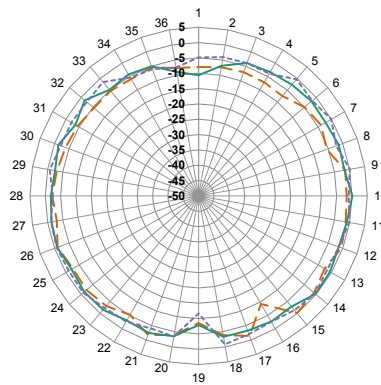

XZ-Plane Gain

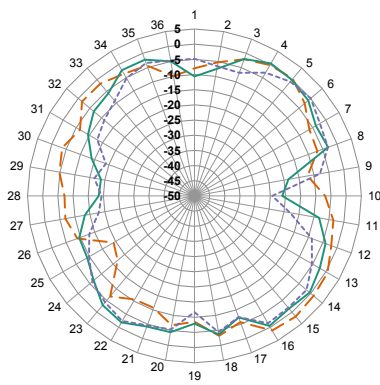

YZ-Plane Gain

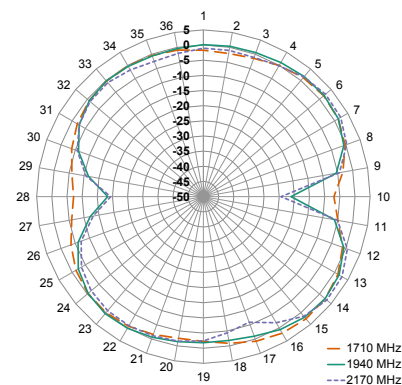

XY-Plane Gain

— 1710 MHz
— 1940 MHz
- - 2170 MHz

2300 MHz TO 2400 MHz (2350 MHz)

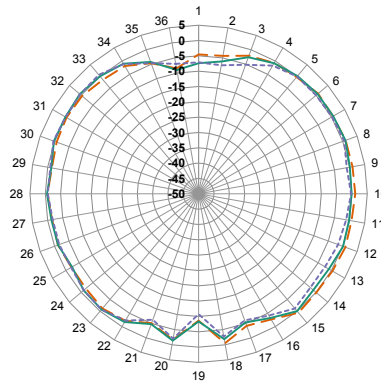

XZ-Plane Gain

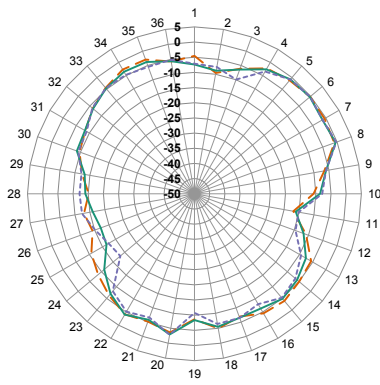

YZ-Plane Gain

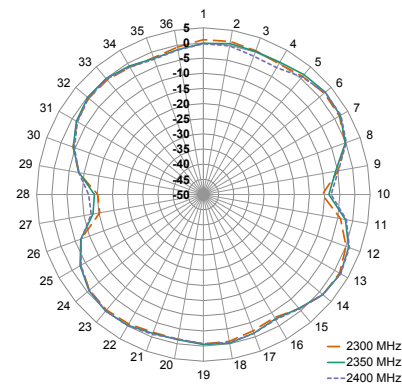

XY-Plane Gain

— 2300 MHz
— 2350 MHz
- - 2400 MHz

RADIATION PATTERNS - EDGE OF GROUND PLANE, BENT 90 DEGREES

2496 MHz TO 2690 MHz (2600 MHz)

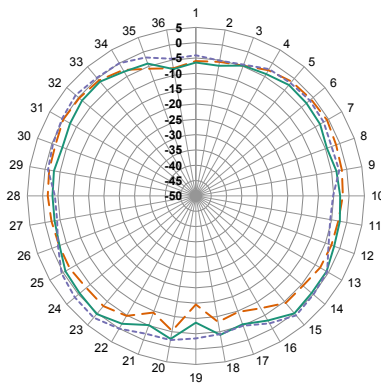

XZ-Plane Gain

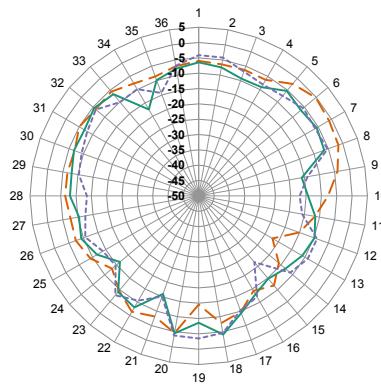

YZ-Plane Gain

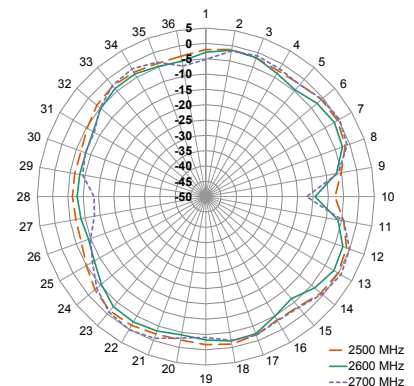

XY-Plane Gain

— 2500 MHz
— 2600 MHz
- - 2700 MHz

3300 MHz TO 3800 MHz (3550 MHz)

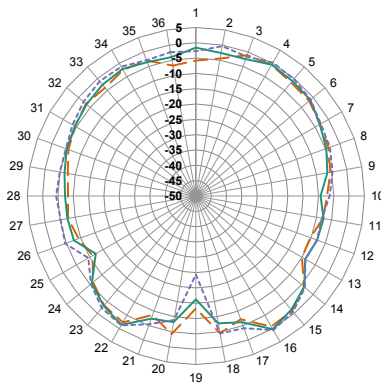

XZ-Plane Gain

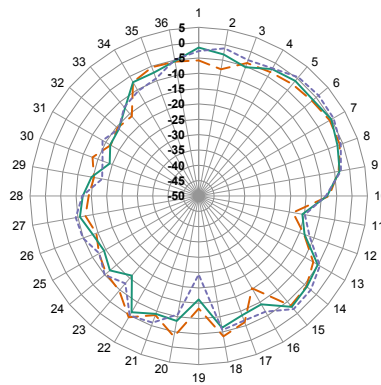

YZ-Plane Gain

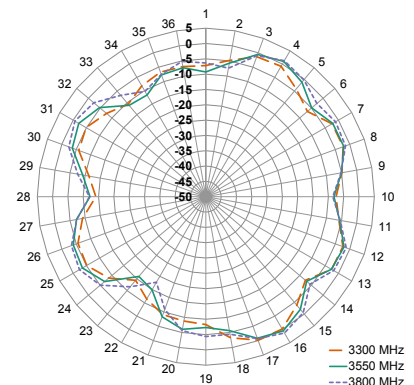

XY-Plane Gain

— 3300 MHz
— 3550 MHz
- - 3800 MHz

2400 MHz TO 2500 MHz (2450 MHz)

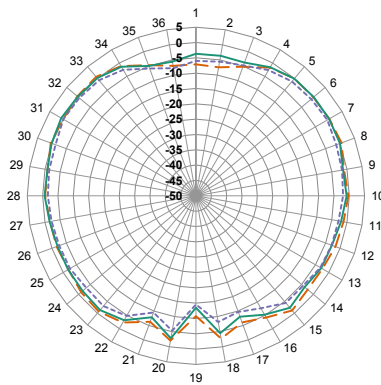

XZ-Plane Gain

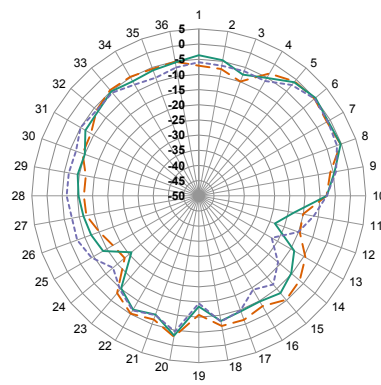

YZ-Plane Gain

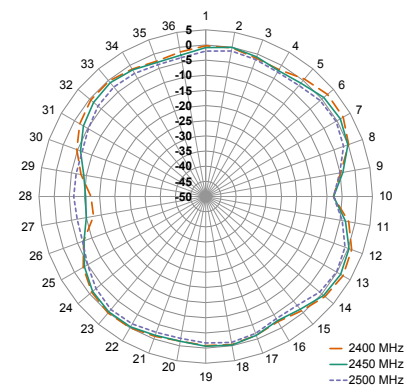

XY-Plane Gain

— 2400 MHz
— 2450 MHz
- - 2500 MHz

TE TECHNICAL SUPPORT CENTER

USA:	+1 (800) 522-6752
Canada:	+1 (905) 475-6222
Mexico:	+52 (0) 55-1106-0800
Latin/S. America:	+54 (0) 11-4733-2200
Germany:	+49 (0) 6251-133-1999
UK:	+44 (0) 800-267666
France:	+33 (0) 1-3420-8686
Netherlands:	+31 (0) 73-6246-999
China:	+86 (0) 400-820-6015

te.com

TE Connectivity, TE, TE connectivity (logo), Linx and Linx Technologies are trademarks owned or licensed by the TE Connectivity Ltd. family of companies. All other logos, products and/or company names referred to herein might be trademarks of their respective owners.

The information given herein, including drawings, illustrations and schematics which are intended for illustration purposes only, is believed to be reliable. However, TE Connectivity makes no warranties as to its accuracy or completeness and disclaims any liability in connection with its use. TE Connectivity's obligations shall only be as set forth in TE Connectivity's Standard Terms and Conditions of Sale for this product and in no case will TE Connectivity be liable for any incidental, indirect or consequential damages arising out of the sale, resale, use or misuse of the product. Users of TE Connectivity products should make their own evaluation to determine the suitability of each such product for the specific application.

TE Connectivity warrants to the original end user customer of its products that its products are free from defects in material and workmanship. Subject to conditions and limitations TE Connectivity will, at its option, either repair or replace any part of its products that prove defective because of improper workmanship or materials. This limited warranty is in force for the useful lifetime of the original end product into which the TE Connectivity product is installed. Useful lifetime of the original end product may vary but is not warranted to exceed one (1) year from the original date of the end product purchase.

©2022 TE Connectivity. All Rights Reserved.

09/22 Original