



ANT-5GLFPC1-UFL-100

Flexible Embedded Sub-6 Cellular LTE/5G Antenna

The 5GLFPC1 antenna is a flexible embedded sub-6 5G cellular and cellular IoT antenna (LTE-M and NB-IoT) ideal for use in lower LTE/5G bands from 698 MHz to 960 MHz and 1427 MHz to 3400 MHz.

The 5GLFPC1 provides a ground plane independent dipole embedded antenna solution comparable in performance to an external antenna. The antenna's flexibility and adhesive backing makes it easy to mount in unique and custom enclosures, while enabling an environmentally sealed enclosure and protection from tampering or accidental antenna damage.

Connection is made to the radio via a 100 mm long, 1.13 mm coaxial cable terminated in a U.FL-type plug (female socket).

FEATURES

- Ground plane independent (dipole)
- Compact, low-profile
 - 39.0 mm x 15.0 mm x 0.2 mm
- U.FL-type plug (female socket) Compatible with MHF1, AMC, UMCC
- Flexible to fit in challenging enclosures
- Adhesive backing permanently adheres to non-metal enclosures using 3M 300LSE™ adhesive

APPLICATIONS

- Global Cellular LTE and 5G
- Cellular IoT: LTE-M (Cat-M1) and NB-IoT including
 - AT&T: bands 12, 17
 - Verizon: band 13
 - Europe: bands 8, 20
 - Latin America: bands 5, 28
 - Asia Pacific: bands 5, 8, 20, 28
- Remote control, monitoring and sensing
- Internet of Things (IoT) devices
- Smart Home networking

ORDERING INFORMATION

Part Number	Description
ANT-5GLFPC1-UFL-100	Cellular antenna with 100 mm of 1.13 mm coaxial cable and U.FL-type plug (female socket)

Available from Linx Technologies and select distributors and representatives.

TABLE 1. ELECTRICAL SPECIFICATIONS

Bands	Frequency Range	VSWR (max.)	Peak Gain (dBi)	Avg. Gain (dBi)	Efficiency (%)
12, 13, 14, 17, 28, 29, 44, 67, 69, 83	698 MHz to 803 MHz	6.8	-3.2	-8.8	15
5, 8, 18, 19, 20, 26, 27, 81, 82, 89	791 MHz to 960 MHz	3.7	-3.0	-8.1	18
11, 21, 24, 32, 45, 50, 51, 74, 75, 76	1427 MHz to 1661 MHz	2.2	3.0	-2.7	55
1, 2, 3, 4, 9, 10, 25, 33, 34, 35, 36, 37, 39, 65, 66, 80, 84, 86, 95	1695 MHz to 2200 MHz	2.9	2.8	-3.3	52
7, 30, 38, 40, 41, 53, 69, 90	2300 MHz to 2700 MHz	2.8	4.4	-2.2	65
52	3300 MHz to 3400 MHz	2.3	5.3	-2.7	58

TABLE 2. MECHANICAL SPECIFICATIONS

Parameter	Value
Polarization	Linear
Radiation	Omnidirectional
Max Power	2 W
Wavelength	1/2-wave
Electrical Type	Dipole
Impedance	50 Ω
Operating Temperature Range	-40 °C to +80 °C
Weight	0.6 g (0.02 oz)
Dimensions	42.0 mm x 12.0 mm x 0.2 mm (1.65 in x 0.47 in x 0.01 in)
Connection	U.FL-type plug (female socket) on 100 mm (3.94 in) of 1.13 mm coaxial cable.

PRODUCT DIMENSIONS

Figure 1 provides dimensions of the ANT-5GW-IPW2-NP antenna.

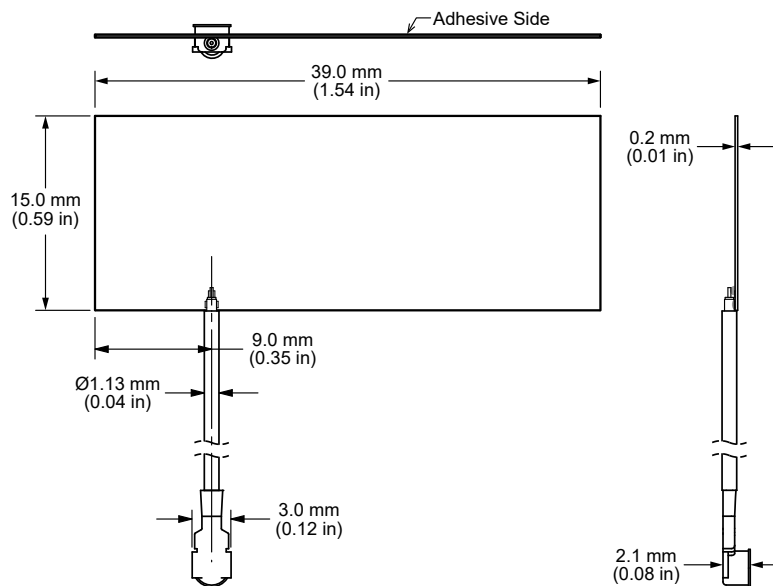

Figure 1. ANT-5GLFPC1-UFL-100 Dimensions

VSWR

Figure 2 provides the voltage standing wave ratio (VSWR) across the antenna bandwidth. VSWR describes the power reflected from the antenna back to the radio. A lower VSWR value indicates better antenna performance at a given frequency. Reflected power is also shown on the right-side vertical axis as a gauge of the percentage of transmitter power reflected back from the antenna.

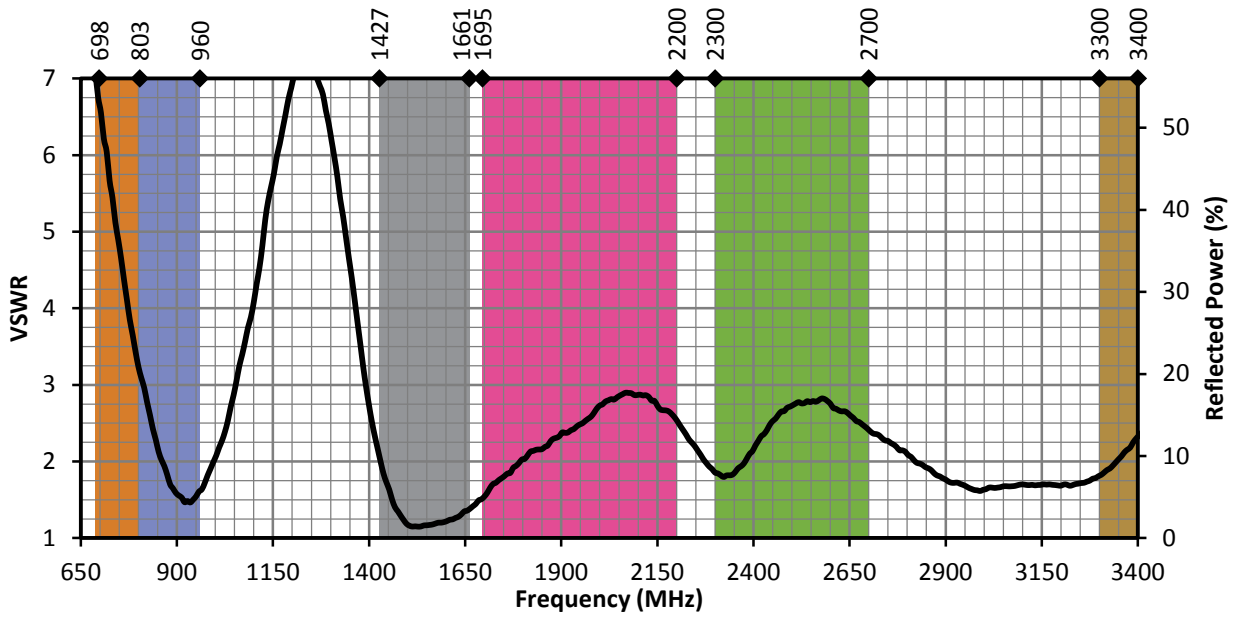

Figure 2. 5GLFPC1 Antenna VSWR with Frequency Band Highlights

RETURN LOSS

Return loss (Figure 3), represents the loss in power at the antenna due to reflected signals. Like VSWR, a lower return loss value indicates better antenna performance at a given frequency.

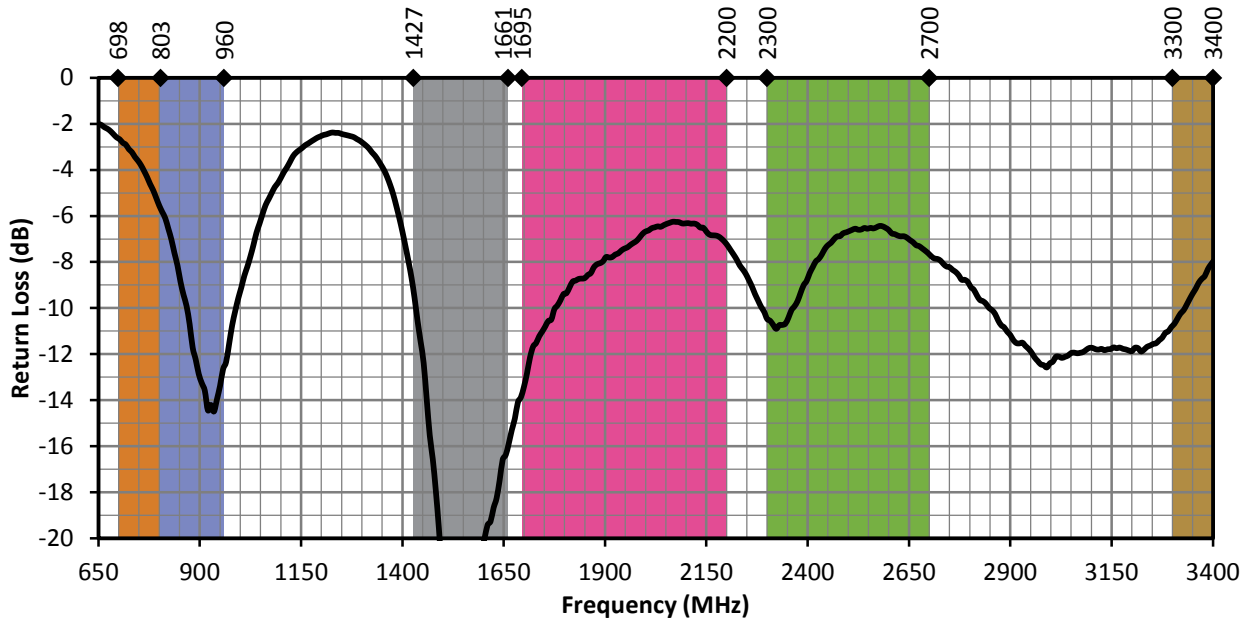

Figure 3. 5GLFPC1 Antenna Return Loss with Frequency Band Highlights

PEAK GAIN

The peak gain across the antenna bandwidth is shown in Figure 4. Peak gain represents the maximum antenna input power concentration across 3-dimensional space, and therefore peak performance, at a given frequency, but does not consider any directionality in the gain pattern.

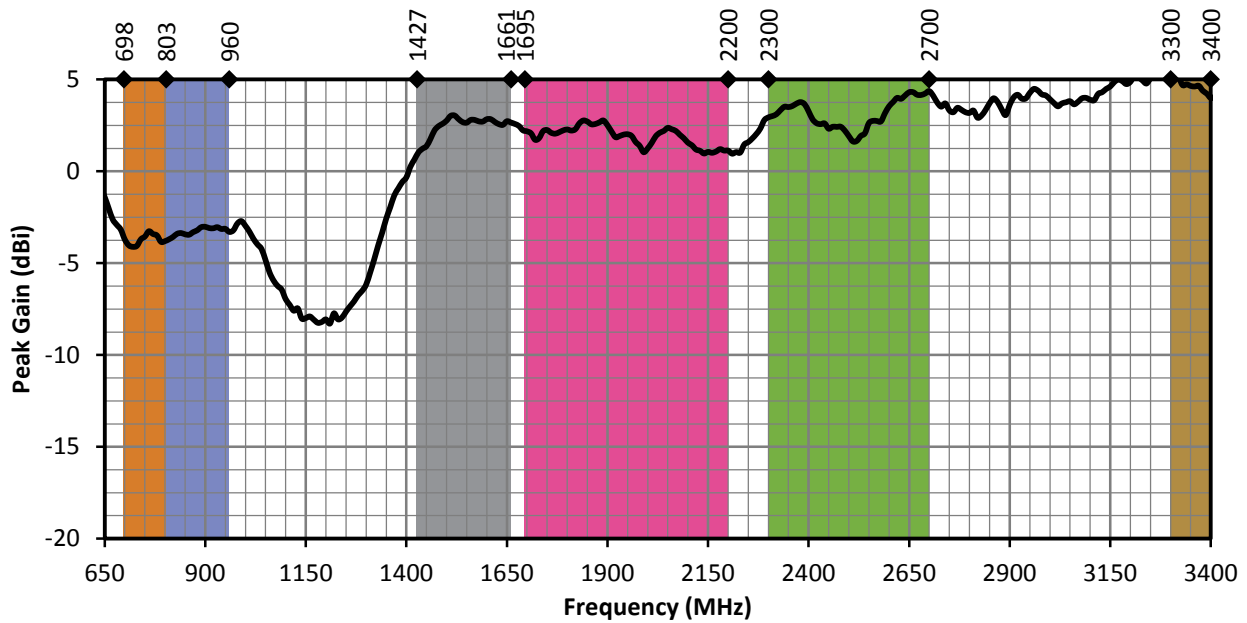

Figure 4. 5GLFPC1 Antenna Peak Gain with Frequency Band Highlights

AVERAGE GAIN

Average gain (Figure 5), is the average of all antenna gain in 3-dimensional space at each frequency, providing an indication of overall performance without expressing antenna directionality.

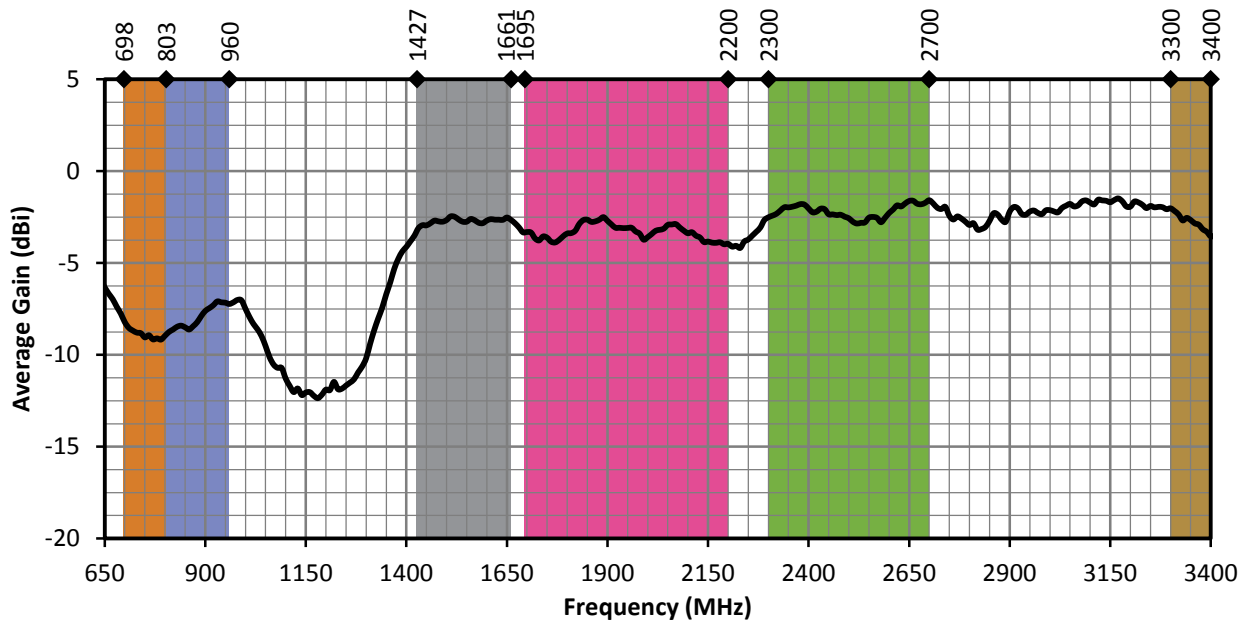

Figure 5. 5GLFPC1 Antenna Average Gain with Frequency Band Highlights

RADIATION EFFICIENCY

Radiation efficiency (Figure 6), shows the ratio of power delivered to the antenna relative to the power radiated at the antenna, expressed as a percentage, where a higher percentage indicates better performance at a given frequency.

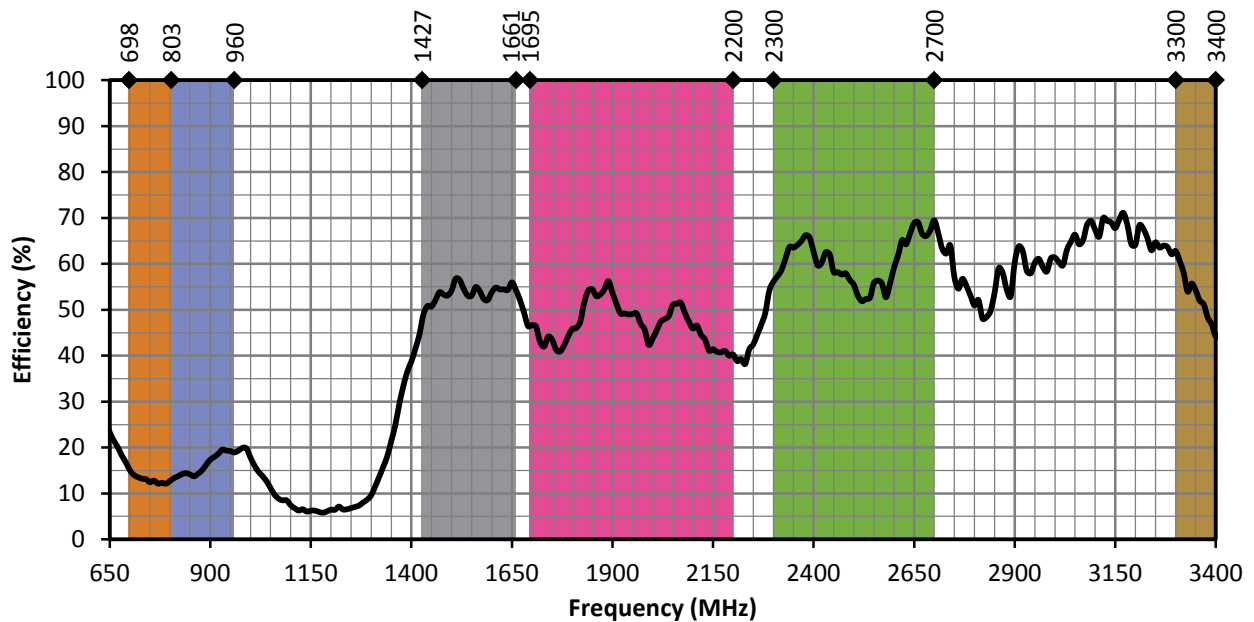
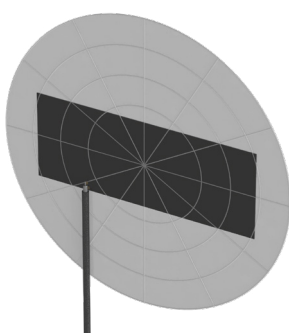

Figure 6. 5GLFPC1 Antenna Radiation Efficiency with Frequency Band Highlights

RADIATION PATTERNS

Radiation patterns provide information about the directionality and 3-dimensional gain performance of the antenna by plotting gain at specific frequencies in three orthogonal planes. Antenna radiation patterns (Figure 7), are shown using polar plots covering 360 degrees. The antenna graphic above the plots provides reference to the plane of the column of plots below it. Note: when viewed with typical PDF viewing software, zooming into radiation patterns is possible to reveal fine detail.

RADIATION PATTERNS - FREE SPACE



XZ-Plane Gain

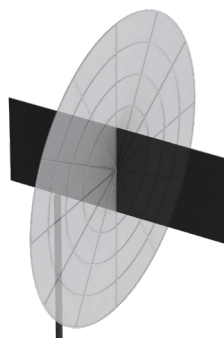

YZ-Plane Gain

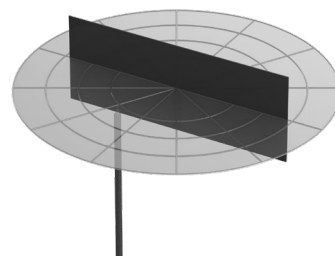

XY-Plane Gain

698 MHz TO 803 MHz (750 MHz)

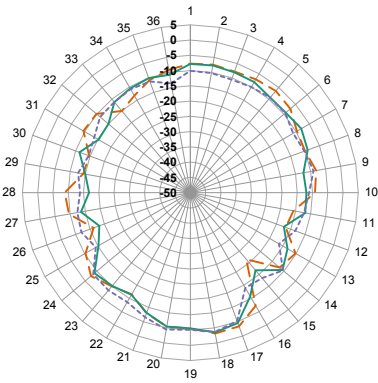

XZ-Plane Gain

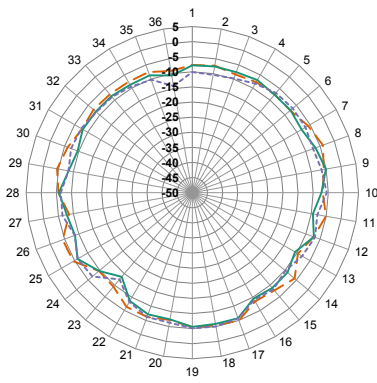

YZ-Plane Gain

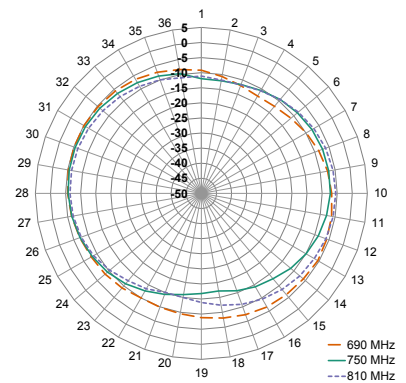

XY-Plane Gain

791 MHz TO 960 MHz (880 MHz)

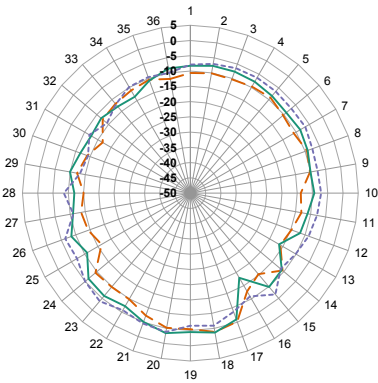

XZ-Plane Gain

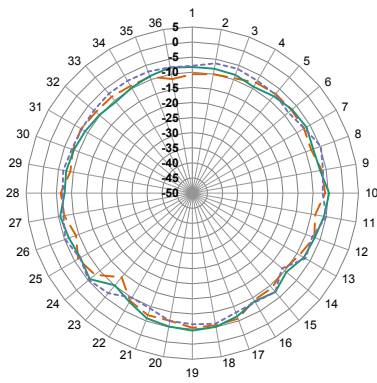

YZ-Plane Gain

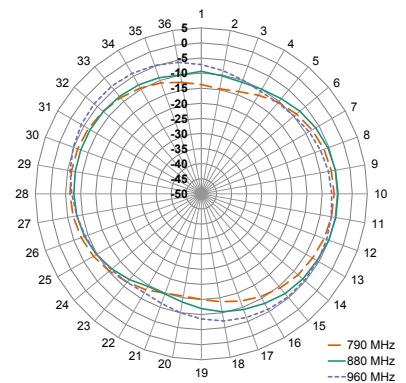

XY-Plane Gain

1427 MHz TO 1661 MHz (1550 MHz)

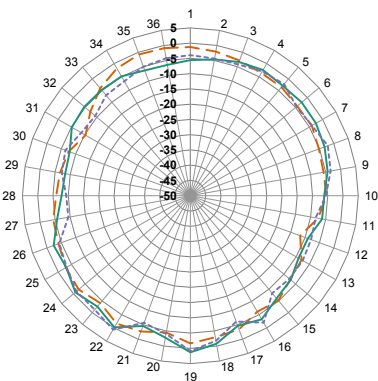

XZ-Plane Gain

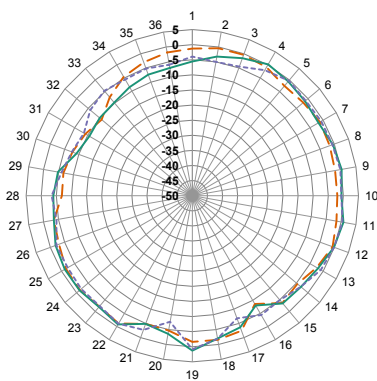

YZ-Plane Gain

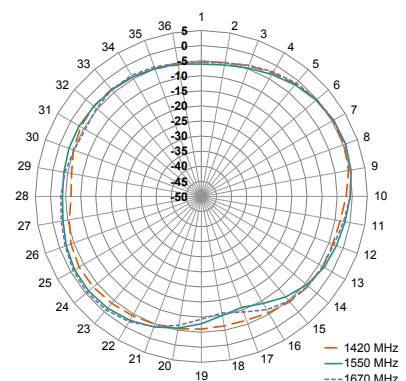

XY-Plane Gain

1695 MHz TO 2200 MHz (1950 MHz)

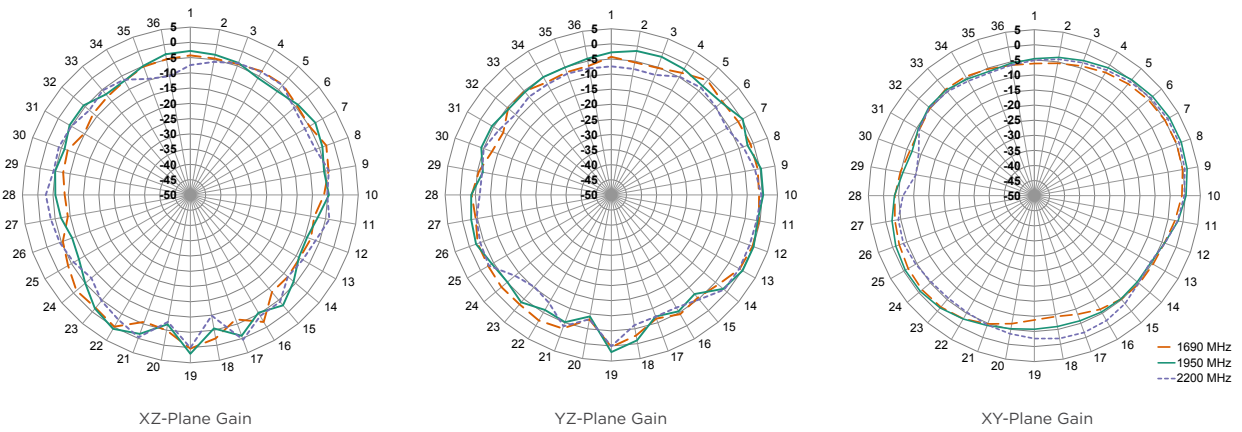

2300 MHz TO 2700 MHz (2500 MHz)

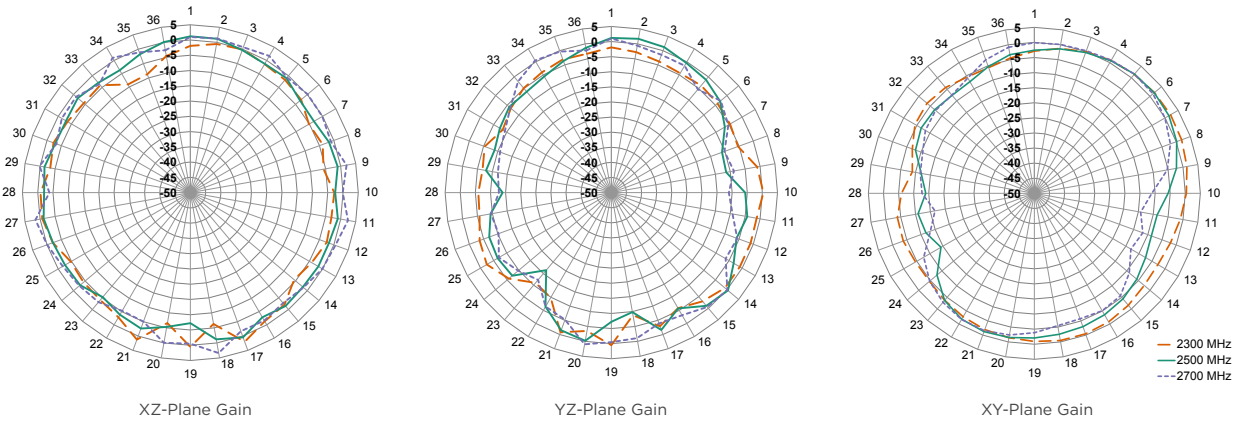

3300 MHz TO 3400 MHz (3350 MHz)

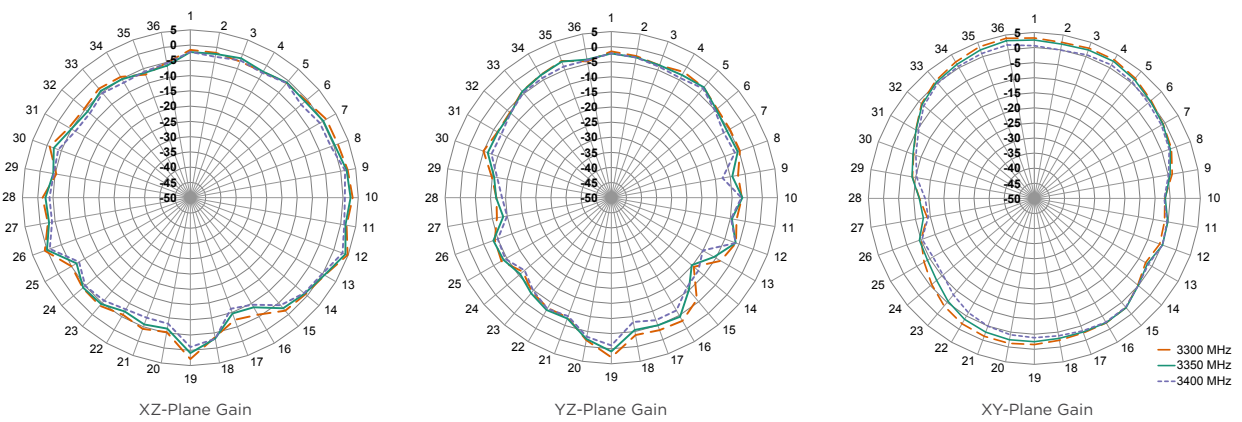

Figure 7. Radiation Patterns for ANT-5GLFPC1-UFL-100 Antenna

ANTENNA MOUNTING

The ANT-5GLFPC1-UFL-100 is a flexible, adhesive backed antenna that allows it to be permanently installed onto non-metallic surfaces. The adhesive backing is 3M 300LSE™, which provides excellent adhesion to high and low surface energy plastics. 3M 300LSE™ adhesive is resistant to solvents, humidity and moisture, as well as heat up to 121 °C (250 °F) for short periods.

The antenna should never be bent to the point of creating a crease or allowing the angle of the bend to fall below 90 degrees (i.e. become acute) as this will impair function and may cause permanent damage.

PACKAGING INFORMATION

The ANT-5GLFPC1-UFL-100 antennas are individually sealed in a clear plastic bag. Individual packages are sealed in a bag of 100 pcs. Distribution channels may offer alternative packaging options.

ANTENNA DEFINITIONS AND USEFUL FORMULAS

VSWR - Voltage Standing Wave Ratio. VSWR is a unitless ratio that describes the power reflected from the antenna back to the radio. A lower VSWR value indicates better antenna performance at a given frequency. VSWR is easily derived from Return Loss.

$$VSWR = \frac{10^{\left[\frac{\text{Return Loss}}{20}\right]} + 1}{10^{\left[\frac{\text{Return Loss}}{20}\right]} - 1}$$

Return Loss - Return loss represents the loss in power at the antenna due to reflected signals, measured in decibels. A lower return loss value indicates better antenna performance at a given frequency. Return Loss is easily derived from VSWR.

$$\text{Return Loss} = -20 \log_{10} \left[\frac{VSWR - 1}{VSWR + 1} \right]$$

Efficiency (η) - The total power radiated from an antenna divided by the input power at the feed point of the antenna as a percentage.

Total Radiated Efficiency - (TRE) The total efficiency of an antenna solution comprising the radiation efficiency of the antenna and the transmitted (forward) efficiency from the transmitter.

$$TRE = \eta \cdot \left(1 - \left(\frac{VSWR - 1}{VSWR + 1} \right)^2 \right)$$

Gain - The ratio of an antenna's efficiency in a given direction (G) to the power produced by a theoretical lossless (100% efficient) isotropic antenna. The gain of an antenna is almost always expressed in decibels.

$$G_{db} = 10 \log_{10}(G)$$

$$G_{dBd} = G_{dBi} - 2.51dB$$

Peak Gain - The highest antenna gain across all directions for a given frequency range. A directional antenna will have a very high peak gain compared to average gain.

Average Gain - The average gain across all directions for a given frequency range.

Maximum Power - The maximum signal power which may be applied to an antenna feed point, typically measured in watts (W).

Reflected Power - A portion of the forward power reflected back toward the amplifier due to a mismatch at the antenna port.

$$\left(\frac{VSWR - 1}{VSWR + 1} \right)^2$$

decibel (dB) - A logarithmic unit of measure of the power of an electrical signal.

decibel isotropic (dBi) - A comparative measure in decibels between an antenna under test and an isotropic radiator.

decibel relative to a dipole (dBd) - A comparative measure in decibels between an antenna under test and an ideal half-wave dipole.

Dipole - An ideal dipole comprises a straight electrical conductor measuring 1/2 wavelength from end to end connected at the center to a feed point for the radio.

Isotropic Radiator - A theoretical antenna which radiates energy equally in all directions as a perfect sphere.

Omnidirectional - Term describing an antenna radiation pattern that is uniform in all directions. An isotropic antenna is the theoretical perfect omnidirectional antenna. An ideal dipole antenna has a donut-shaped radiation pattern and other practical antenna implementations will have less perfect but generally omnidirectional radiation patterns which are typically plotted on three axes.

TE TECHNICAL SUPPORT CENTER

USA:	+1 (800) 522-6752
Canada:	+1 (905) 475-6222
Mexico:	+52 (0) 55-1106-0800
Latin/S. America:	+54 (0) 11-4733-2200
Germany:	+49 (0) 6251-133-1999
UK:	+44 (0) 800-267666
France:	+33 (0) 1-3420-8686
Netherlands:	+31 (0) 73-6246-999
China:	+86 (0) 400-820-6015

te.com

TE Connectivity, TE, TE connectivity (logo), Linx and Linx Technologies are trademarks owned or licensed by the TE Connectivity Ltd. family of companies. All other logos, products and/or company names referred to herein might be trademarks of their respective owners.

The information given herein, including drawings, illustrations and schematics which are intended for illustration purposes only, is believed to be reliable. However, TE Connectivity makes no warranties as to its accuracy or completeness and disclaims any liability in connection with its use. TE Connectivity's obligations shall only be as set forth in TE Connectivity's Standard Terms and Conditions of Sale for this product and in no case will TE Connectivity be liable for any incidental, indirect or consequential damages arising out of the sale, resale, use or misuse of the product. Users of TE Connectivity products should make their own evaluation to determine the suitability of each such product for the specific application.

TE Connectivity warrants to the original end user customer of its products that its products are free from defects in material and workmanship. Subject to conditions and limitations TE Connectivity will, at its option, either repair or replace any part of its products that prove defective because of improper workmanship or materials. This limited warranty is in force for the useful lifetime of the original end product into which the TE Connectivity product is installed. Useful lifetime of the original end product may vary but is not warranted to exceed one (1) year from the original date of the end product purchase.

©2022 TE Connectivity. All Rights Reserved.

09/22 Original