



VDP Industrial Series

Remote Adhesive-Mount Cellular Antenna

The Linx VDP industrial series offers rugged remote-mount dipole antennas having excellent performance for all common 5G and LTE bands and cellular IoT (LTE-M and NB-IoT) applications.

The VDP industrial antennas are durable, low profile, IP67 ratable, and UV protected. They mount permanently to non-conductive surfaces using the integrated adhesive patch and connect using 2 meters of RG-174/U low-loss cable terminated in an SMA plug (male pin) connector.

FEATURES

- Performance at 617 MHz to 803 MHz
 - VSWR: ≤ 2.5
 - Peak Gain: 4.9 dBi
 - Efficiency: 60%
- Low profile
 - 115.0 mm x 22.0 mm x 6.3 mm
- Durable UV protected enclosure rated at IP67 for heavy-duty outdoor use
- Low-loss RG-174/U coaxial cable for improved performance at higher frequencies
- SMA plug (male pin)

APPLICATIONS

- Worldwide 5G, LTE, UMTS and GSM
- Cellular IoT: LTE-M (Cat-M1) and NB-IoT
- Frequency bands
 - T-Mobile: band 71
 - AT&T: bands 12, 14, 17
 - Verizon: band 13
 - Europe: bands 8, 20
 - Latin America: bands 5, 28
 - Asia Pacific: bands 5, 8, 20, 28
- Global Navigation (GNSS)
- Internet of Things (IoT) devices

ORDERING INFORMATION

Part Number	Description
ANT-LTE-VDP-2000-SMA	Remote adhesive-mount cellular antenna with 2 m of RG-174/U low-loss coaxial cable terminated in an SMA plug (male pin)

Available from Linx Technologies and select distributors and representatives.

TABLE 1. ELECTRICAL SPECIFICATIONS

ANT-LTE-VDP-2000	Frequency Range	VSWR (max.)	Peak Gain (dBi)	Avg. Gain (dBi)	Efficiency (%)
LTE 71	617 MHz to 698 MHz	2.5	4.2	-5.6	56
LTE 12, 13, 14, 17, 26, 28, 29	698 MHz to 803 MHz	1.6	4.9	-2.4	62
LTE 5, 8, 20	791 MHz to 960 MHz	2.2	4.9	-3.6	62
LTE 1, 2, 3, 4, 25, 66	1710 MHz to 2200 MHz	1.5	3.9	-4.1	42
LTE 30, 40	2300 MHz to 2400 MHz	1.5	1.8	-6.0	27
LTE 7, 41	2496 MHz to 2690 MHz	1.5	4.5	-5.6	30
LTE 22, 42, 43, 48, 49, 52	3300 MHz to 3800 MHz	1.4	1.3	-9.7	13
GPS/GNSS	1553 MHz to 1609 MHz	1.7	4.2	-3.1	50
CBRS	3550 MHz to 3700 MHz	1.3	0	-10.0	10
C-Band	3700 MHz to 4200 MHz	1.4	-0.6	-11.7	8
Public Safety	4940 MHz to 4990 MHz	1.5	-3.3	-13.6	5
Polarization	Linear	Radiation		Omnidirectional	
Impedance	50 Ω	Max Power		10 W	
Wavelength	1/2-wave	Electrical Type		Dipole	

TABLE 2. MECHANICAL SPECIFICATIONS

ANT-LTE-VDP-2000	Value
Connection	SMA plug (male pin)
Cable	2.0 m (78.74 in) of RG-174/U low-loss coaxial cable
Operating Temp. Range	-40 °C to +85 °C
Weight	47.0 g (1.66 oz)
Dimensions	115.0 mm x 22.0 mm x 6.2 mm (4.53 in x 0.87 in x 0.24 in)
Dimensions	203.0 mm x 13.2 mm x 13.2 mm (7.99 in x 0.52 in x 0.52 in)

PRODUCT DIMENSIONS

Figure 1 provides dimensions of the ANT-8/9-IPW1-SMA. The antenna whip can be tilted 90 degrees, with a detent at 45 degrees enabling the antenna to be oriented in any direction. The rotating base allows for continuous positioning through 360 degrees even while installed.

ANTENNA MOUNTING

The remote adhesive-mount VDP industrial series antenna mounts permanently to non-conductive surfaces using the integrated adhesive patch. The mounting surface should be clean, dry and free of oil residue for ideal adhesion.

PACKAGING INFORMATION

The VDP industrial series antennas are packaged in bags of 50. Distribution channels may offer alternative packaging options.

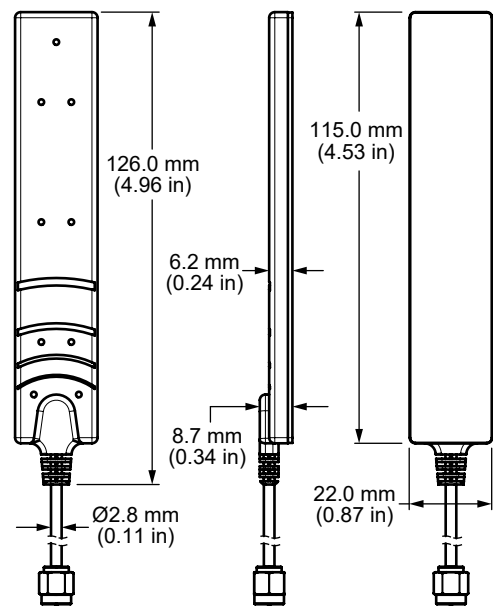

Figure 1. ANT-LTE-VDP-2000 Antenna Dimensions

VSWR

Figure 2 provides the voltage standing wave ratio (VSWR) across the antenna bandwidth. VSWR describes the power reflected from the antenna back to the radio. A lower VSWR value indicates better antenna performance at a given frequency. Reflected power is also shown on the right-side vertical axis as a gauge of the percentage of transmitter power reflected back from the antenna.

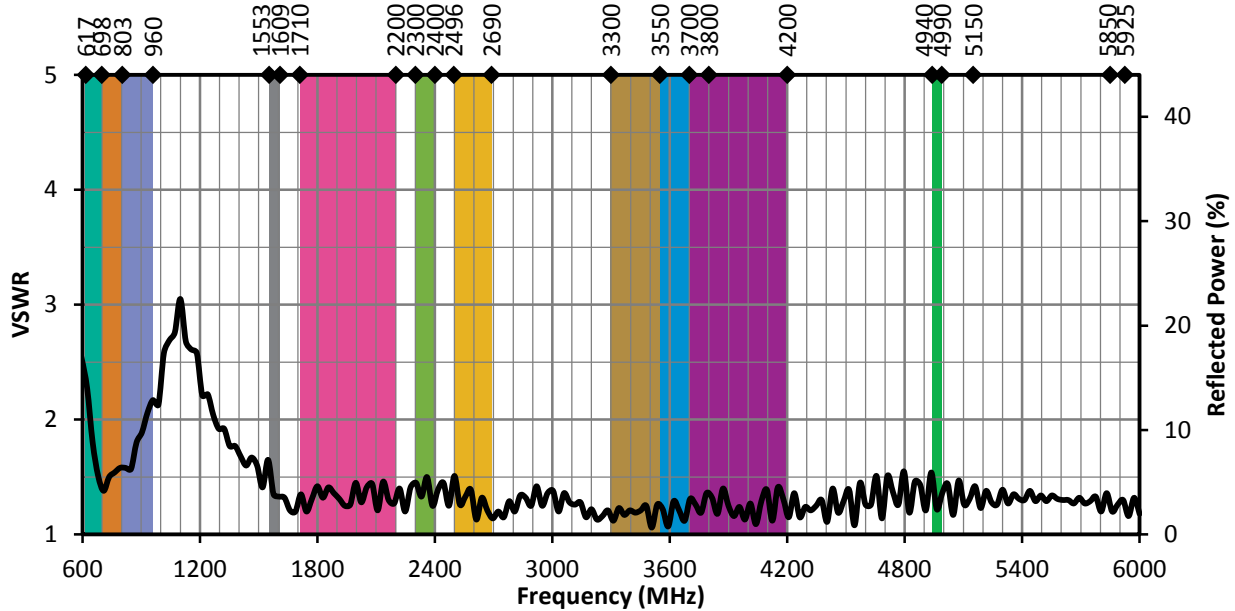

Figure 2. ANT-LTE-VDP-2000-SMA VSWR with Frequency Band Highlights

RETURN LOSS

Return loss (Figure 3), represents the loss in power at the antenna due to reflected signals. Like VSWR, a lower return loss value indicates better antenna performance at a given frequency.

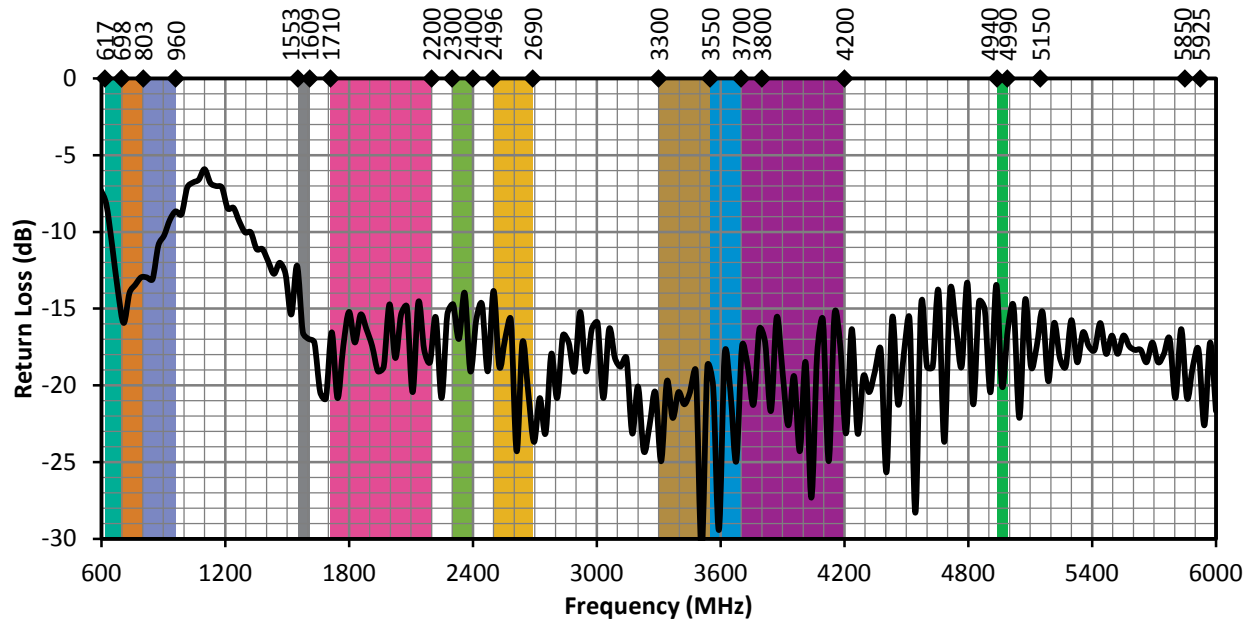

Figure 3. ANT-LTE-VDP-2000-SMA Return Loss with Frequency Band Highlights

PEAK GAIN

The peak gain across the antenna bandwidth is shown in Figure 4. Peak gain represents the maximum antenna input power concentration across 3-dimensional space, and therefore peak performance at a given frequency, but does not consider any directionality in the gain pattern.

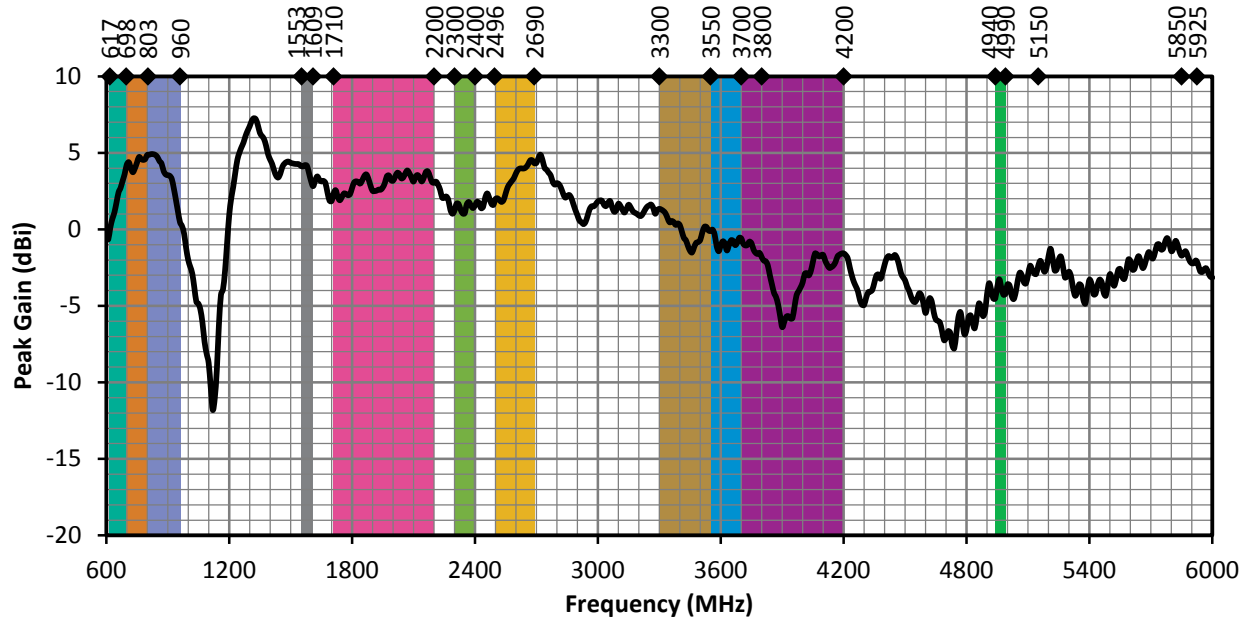

Figure 4. ANT-LTE-VDP-2000-SMA Peak Gain with Frequency Band Highlights

AVERAGE GAIN

Average gain (Figure 5), is the average of all antenna gain in 3-dimensional space at each frequency, providing an indication of overall performance without expressing antenna directionality.

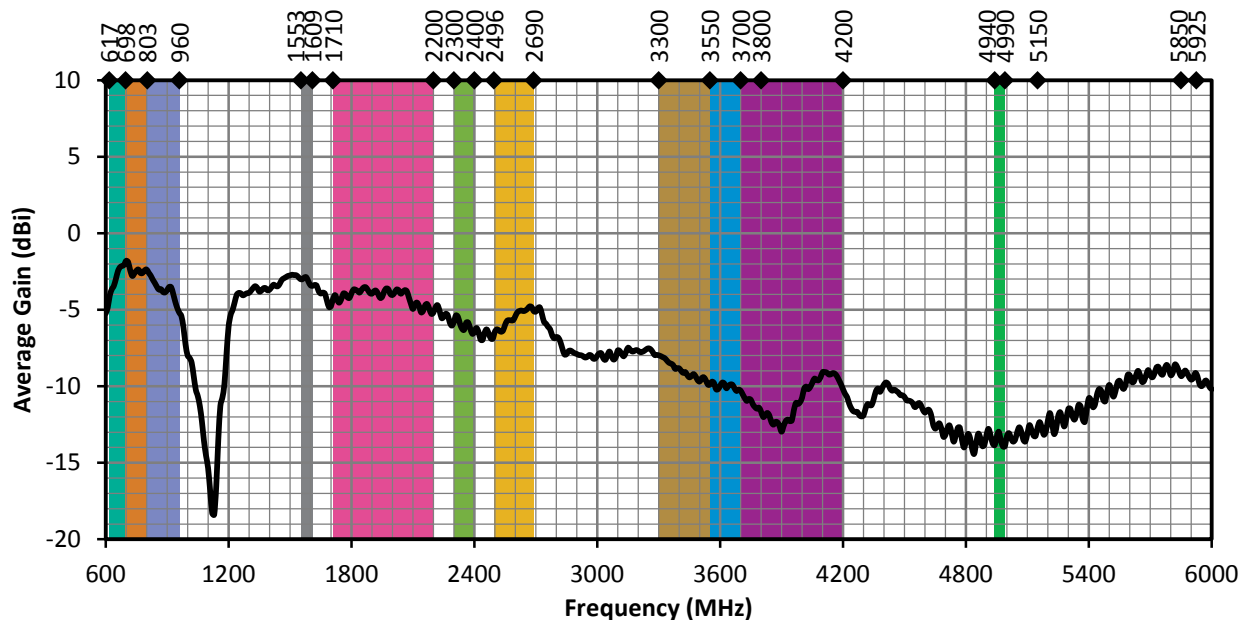

Figure 5. ANT-LTE-VDP-2000-SMA Antenna Average Gain with Frequency Band Highlights

RADIATION EFFICIENCY

Radiation efficiency (Figure 6), shows the ratio of power delivered to the antenna relative to the power radiated at the antenna, expressed as a percentage, where a higher percentage indicates better performance at a given frequency.

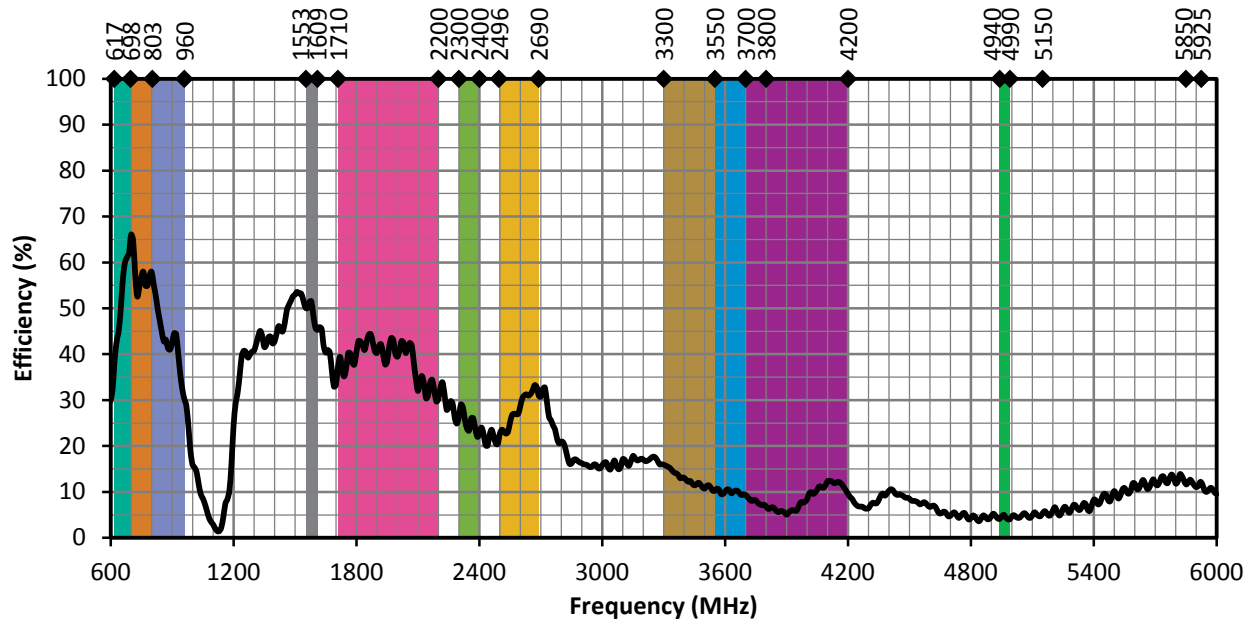

Figure 6. ANT-LTE-VDP-2000-SMA Antenna Radiation Efficiency with Frequency Band Highlights

RADIATION PATTERNS

Radiation patterns provide information about the directionality and 3-dimensional gain performance of the antenna by plotting gain at specific frequencies in three orthogonal planes. Antenna radiation patterns are shown in Figure 7 using polar plots covering 360 degrees. The antenna graphic at the top of the page provides reference to the plane of the column of plots below it. Note: when viewed with typical PDF viewing software, zooming into radiation patterns is possible to reveal fine detail.



RADIATION PATTERNS



XZ-Plane Gain



YZ-Plane Gain



XY-Plane Gain

617 MHz TO 698 MHz (660 MHz)

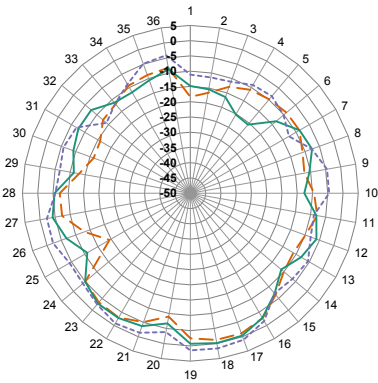

XZ-Plane Gain

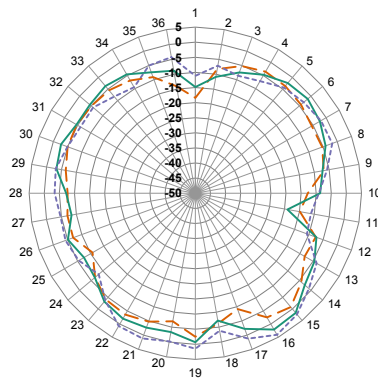

YZ-Plane Gain

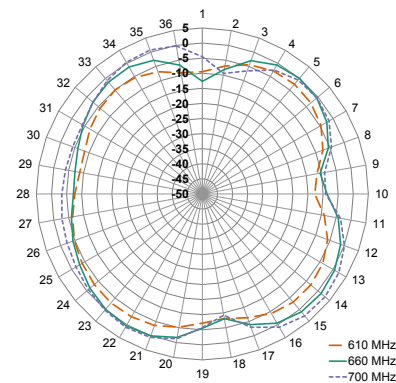

XY-Plane Gain

— 610 MHz
— 660 MHz
- - 700 MHz

698 MHz TO 803 MHz (750 MHz)

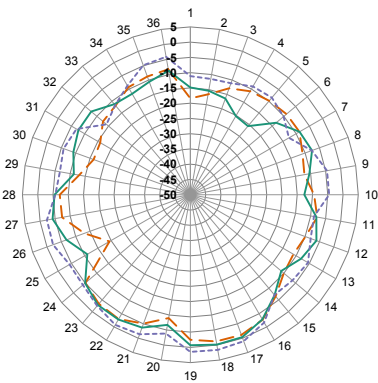

XZ-Plane Gain

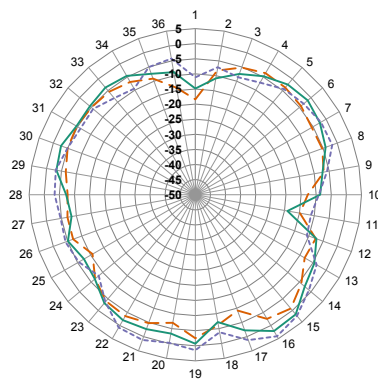

YZ-Plane Gain

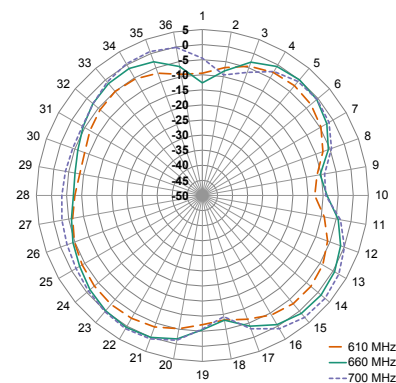

XY-Plane Gain

— 610 MHz
— 660 MHz
- - 700 MHz

RADIATION PATTERNS



XZ-Plane Gain



YZ-Plane Gain



XY-Plane Gain

791 MHz TO 960 MHz (870 MHz)

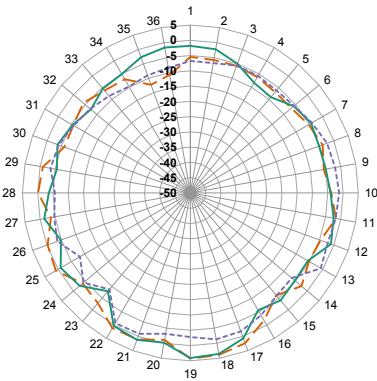

XZ-Plane Gain

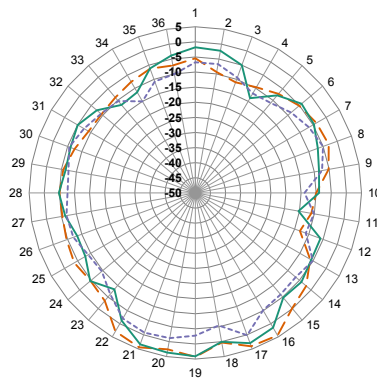

YZ-Plane Gain

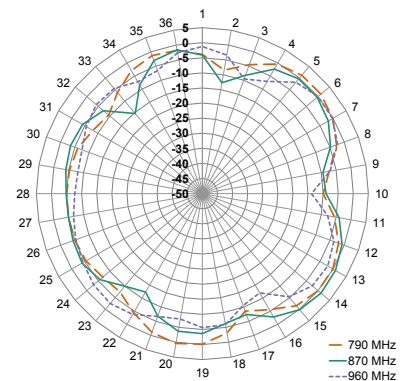

XY-Plane Gain

— 790 MHz
— 870 MHz
- - 960 MHz

1710 MHz TO 2200 MHz (1950 MHz)

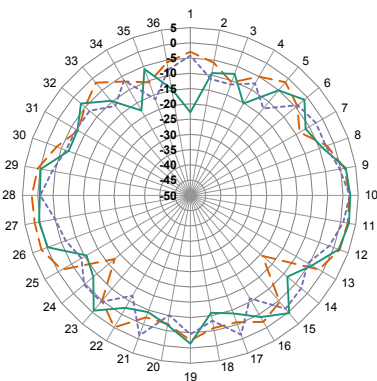

XZ-Plane Gain

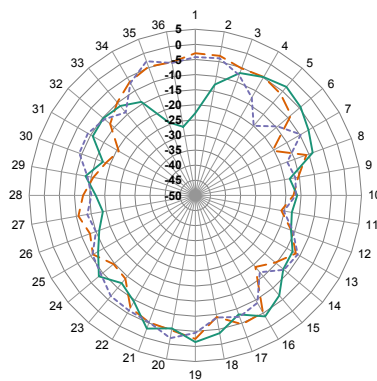

YZ-Plane Gain

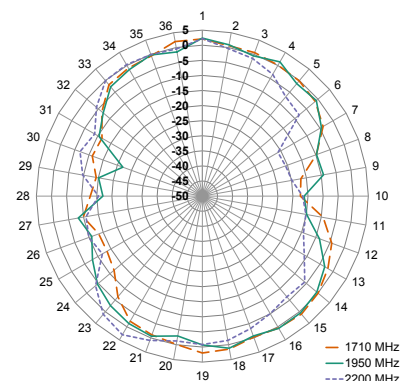

XY-Plane Gain

— 1710 MHz
— 1950 MHz
- - 2200 MHz

RADIATION PATTERNS



XZ-Plane Gain



YZ-Plane Gain



XY-Plane Gain

2300 MHz TO 2400 MHz (2350 MHz)

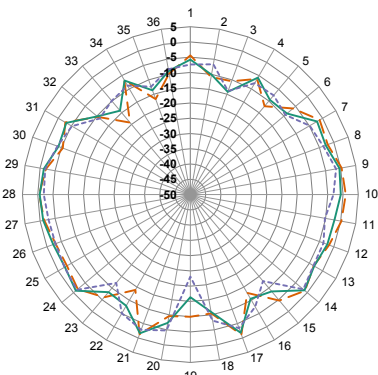

XZ-Plane Gain

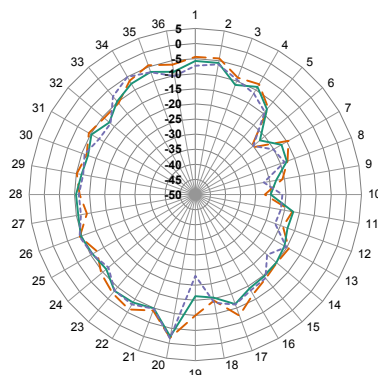

YZ-Plane Gain

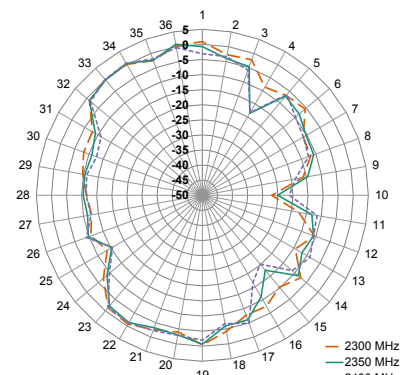

XY-Plane Gain

— 2300 MHz
— 2350 MHz
- - 2400 MHz

2496 MHz TO 2690 MHz (2600 MHz)

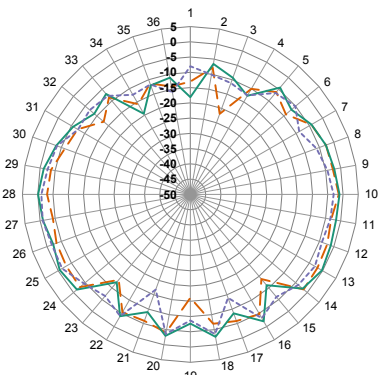

XZ-Plane Gain

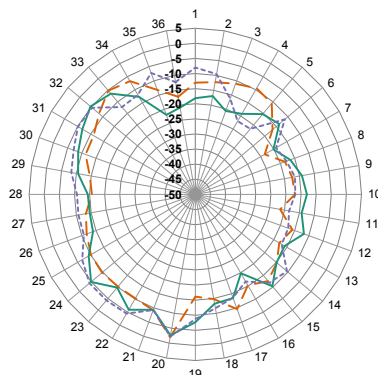

YZ-Plane Gain

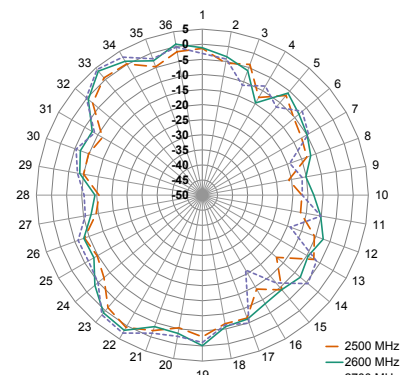

XY-Plane Gain

— 2500 MHz
— 2600 MHz
- - 2700 MHz

Figure 7. ANT-LTE-VDP-2000-SMA Radiation Patterns

ANTENNA DEFINITIONS AND USEFUL FORMULAS

VSWR - Voltage Standing Wave Ratio. VSWR is a unitless ratio that describes the power reflected from the antenna back to the radio. A lower VSWR value indicates better antenna performance at a given frequency. VSWR is easily derived from Return Loss.

$$\text{VSWR} = \frac{10^{\left[\frac{\text{Return Loss}}{20}\right]} + 1}{10^{\left[\frac{\text{Return Loss}}{20}\right]} - 1}$$

Return Loss - Return loss represents the loss in power at the antenna due to reflected signals, measured in decibels. A lower return loss value indicates better antenna performance at a given frequency. Return Loss is easily derived from VSWR.

$$\text{Return Loss} = -20 \log_{10} \left[\frac{\text{VSWR} - 1}{\text{VSWR} + 1} \right]$$

Efficiency (η) - The total power radiated from an antenna divided by the input power at the feed point of the antenna as a percentage.

Total Radiated Efficiency - (TRE) The total efficiency of an antenna solution comprising the radiation efficiency of the antenna and the transmitted (forward) efficiency from the transmitter.

$$\text{TRE} = \eta \cdot \left(1 - \left(\frac{\text{VSWR} - 1}{\text{VSWR} + 1} \right)^2 \right)$$

Gain - The ratio of an antenna's efficiency in a given direction (G) to the power produced by a theoretical lossless (100% efficient) isotropic antenna. The gain of an antenna is almost always expressed in decibels.

$$G_{\text{db}} = 10 \log_{10}(G)$$

$$G_{\text{dBd}} = G_{\text{dBi}} - 2.51\text{dB}$$

Peak Gain - The highest antenna gain across all directions for a given frequency range. A directional antenna will have a very high peak gain compared to average gain.

Average Gain - The average gain across all directions for a given frequency range.

Maximum Power - The maximum signal power which may be applied to an antenna feed point, typically measured in watts (W).

Reflected Power - A portion of the forward power reflected back toward the amplifier due to a mismatch at the antenna port.

$$\left(\frac{\text{VSWR} - 1}{\text{VSWR} + 1} \right)^2$$

decibel (dB) - A logarithmic unit of measure of the power of an electrical signal.

decibel isotropic (dBi) - A comparative measure in decibels between an antenna under test and an isotropic radiator.

decibel relative to a dipole (dBd) - A comparative measure in decibels between an antenna under test and an ideal half-wave dipole.

Dipole - An ideal dipole comprises a straight electrical conductor measuring 1/2 wavelength from end to end connected at the center to a feed point for the radio.

Isotropic Radiator - A theoretical antenna which radiates energy equally in all directions as a perfect sphere.

Omnidirectional - Term describing an antenna radiation pattern that is uniform in all directions. An isotropic antenna is the theoretical perfect omnidirectional antenna. An ideal dipole antenna has a donut-shaped radiation pattern and other practical antenna implementations will have less perfect but generally omnidirectional radiation patterns which are typically plotted on three axes.

TE TECHNICAL SUPPORT CENTER

USA:	+1 (800) 522-6752
Canada:	+1 (905) 475-6222
Mexico:	+52 (0) 55-1106-0800
Latin/S. America:	+54 (0) 11-4733-2200
Germany:	+49 (0) 6251-133-1999
UK:	+44 (0) 800-267666
France:	+33 (0) 1-3420-8686
Netherlands:	+31 (0) 73-6246-999
China:	+86 (0) 400-820-6015

te.com

TE Connectivity, TE, TE connectivity (logo), Linx and Linx Technologies are trademarks owned or licensed by the TE Connectivity Ltd. family of companies. All other logos, products and/or company names referred to herein might be trademarks of their respective owners.

The information given herein, including drawings, illustrations and schematics which are intended for illustration purposes only, is believed to be reliable. However, TE Connectivity makes no warranties as to its accuracy or completeness and disclaims any liability in connection with its use. TE Connectivity's obligations shall only be as set forth in TE Connectivity's Standard Terms and Conditions of Sale for this product and in no case will TE Connectivity be liable for any incidental, indirect or consequential damages arising out of the sale, resale, use or misuse of the product. Users of TE Connectivity products should make their own evaluation to determine the suitability of each such product for the specific application.

TE Connectivity warrants to the original end user customer of its products that its products are free from defects in material and workmanship. Subject to conditions and limitations TE Connectivity will, at its option, either repair or replace any part of its products that prove defective because of improper workmanship or materials. This limited warranty is in force for the useful lifetime of the original end product into which the TE Connectivity product is installed. Useful lifetime of the original end product may vary but is not warranted to exceed one (1) year from the original date of the end product purchase.

©2022 TE Connectivity. All Rights Reserved.

09/22 Original