



Connectors > Power Connectors > Circular Power > Circular Power Connectors



Connector Product Type: **Housing**

Operating Voltage: **600 VDC**

Connector System: **Wire-to-Wire**

Number of Positions: **16**

Sealable: **No**

Features

Product Type Features

Connector Product Type	Housing
Connector System	Wire-to-Wire
Sealable	No
Connector & Contact Terminates To	Wire & Cable
Connector & Housing Type	Plug
Circular Connector Shell Type	All Plastic

Configuration Features

Reverse Numbering	Without
Number of Positions	16
Number of Power Positions	4
Number of Signal Positions	12

Electrical Characteristics

Operating Voltage	600 VAC
-------------------	---------

Contact Features



Reverse Gender	No
Contact Type	Socket
Contact Protection	With

Termination Features

Termination Method to Wire & Cable	Crimp
------------------------------------	-------

Mechanical Attachment

Mating Alignment Type	Keyed
Mating Alignment	With
Mating Retention Type	Threaded Coupling
Screw & Hole Thread Size	1-3/8 - 18 UNEF-2A
Connector Mounting Type	Cable Mount (Free-Hanging)
Mating Retention	With
Panel Mount Feature	Without

Housing Features

Body Orientation	Straight
Housing Color	Black
Housing Material	PA 6.6 GF
Circular Connector Shell Size	23

Usage Conditions

Operating Temperature Range	-55 – 105 °C[-67 – 221 °F]
Fluid Resistance	None

Operation/Application

Circuit Application	Power & Signal
Shielded	No

Industry Standards

UL Flammability Rating	UL 94V-0
------------------------	----------

Packaging Features

Packaging Quantity	100
Packaging Method	Standard

Product Compliance

[For compliance documentation, visit the product page on TE.com>](#)

EU RoHS Directive 2011/65/EU	Compliant
EU ELV Directive 2000/53/EC	Compliant
China RoHS 2 Directive MIIT Order No 32, 2016	No Restricted Materials Above Threshold
EU REACH Regulation (EC) No. 1907/2006	Current ECHA Candidate List: JAN 2023 (233) Candidate List Declared Against: JAN 2023 (233) Does not contain REACH SVHC
Halogen Content	BFR/CFR/PVC Free, but Br/Cl >900 ppm in other sources.
Solder Process Capability	Not applicable for solder process capability

Product Compliance Disclaimer

This information is provided based on reasonable inquiry of our suppliers and represents our current actual knowledge based on the information they provided. This information is subject to change. The part numbers that TE has identified as EU RoHS compliant have a maximum concentration of 0.1% by weight in homogenous materials for lead, hexavalent chromium, mercury, PBB, PBDE, DBP, BBP, DEHP, DIBP, and 0.01% for cadmium, or qualify for an exemption to these limits as defined in the Annexes of Directive 2011/65/EU (RoHS2). Finished electrical and electronic equipment products will be CE marked as required by Directive 2011/65/EU. Components may not be CE marked. Additionally, the part numbers that TE has identified as EU ELV compliant have a maximum concentration of 0.1% by weight in homogenous materials for lead, hexavalent chromium, and mercury, and 0.01% for cadmium, or qualify for an exemption to these limits as defined in the Annexes of Directive 2000/53/EC (ELV). Regarding the REACH Regulation, the information TE provides on SVHC in articles for this part number is based on the latest European Chemicals Agency (ECHA) 'Guidance on requirements for substances in articles' posted at this URL: <https://echa.europa.eu/guidance-documents/guidance-on-reach>

Compatible Parts



TE Part # CAT-AM71-C83998CC
CPC Connector Housing, Series 4



TE Part # 207486-5
SIZE 23-16 RECEPT,CPC,W/SEAL

Also in the Series | AMP CPC



Circular Connector Adapters(7)



Circular Connector Boots & Strain Relief(6)



Circular Connector Caps & Covers(16)



Circular Connector Hardware(3)



Circular Connector Keying Plugs(2)



Circular Connector Seals(36)



Circular Power Connectors(459)



Insertion & Extraction Tools(1)

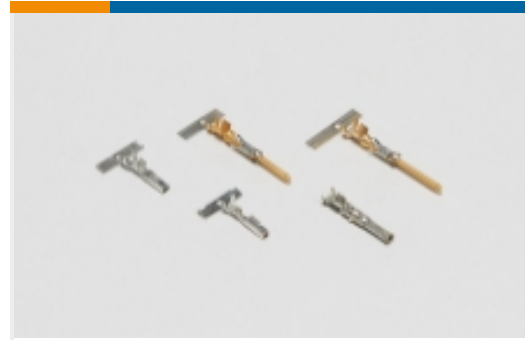

Power Contacts(6)

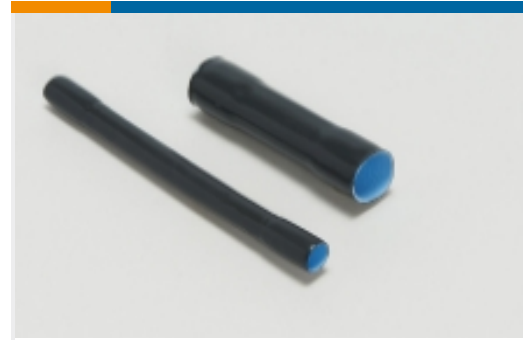

Sealing Sleeves(2)



Unscreened Circular Connector Backshells & Clamps(56)

Customers Also Bought



TE Part #207486-2
CPC Connector Housing, Series 4



TE Part #206838-1
23-24 RECEPT



TE Part #206837-1
CPC PLUG ASSEMBLY SIZE 23-24



TE Part #DT04-12PA-L012
DEUTSCH DT Receptacle Connectors

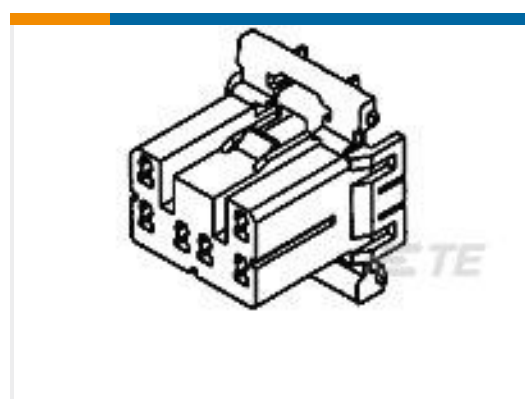

TE Part #173851-1
070 MULTILOCK PLUG 12P



TE Part #DT06-6S-CE06
PLG, 6P, BLK, E, SEAL RET



TE Part #1-480708-0
12P UMNL PLUG HSG NATL



TE Part #DTM04-12PB-L012
REC, 12P, BLK, N, FLANGE, B

Documents

Product Drawings

CPC PLUG ASSEMBLY SIZE 23-16

English

CAD Files

3D PDF

3D

Customer View Model

ENG_CVM_CVM_207485-2_K.2d_dxf.zip



English

Customer View Model

[ENG_CVM_CVM_207485-2_K.3d_igs.zip](#)

English

Customer View Model

[ENG_CVM_CVM_207485-2_K.3d_stp.zip](#)

English

Customer View Model

[ENG_CVM_207485-2_G1.3d_igs.zip](#)

English

Customer View Model

[ENG_CVM_207485-2_G1.3d_stp.zip](#)

English

Customer View Model

[ENG_CVM_207485-2_G1.2d_dxf.zip](#)

English

[3D PDF](#)

3D

By downloading the CAD file I accept and agree to the [Terms and Conditions](#) of use.

Product Specifications

[Connector, Circular Plastic](#)

English

[Product Specification](#)

English

Agency Approvals

[CSA Certificate](#)

English

[CSA Certificate](#)

English