

## Features

High Daylight Visibility, Multicolor Indicator with Optional Audible Alarm for Indoor or Outdoor Use

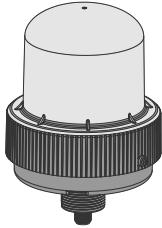

- Highly visible indicator provides bright, even light in direct sunlight
- Ex/HazLoc approvals for potentially explosive environment applications
- Three colors in one device
- 36 mm threaded polycarbonate base
- Rugged IP69K per DIN 40050-9, UL Type 4X housing
- Variety of connector options
- Rugged UV-stabilized polycarbonate base and window
- 100 V AC to 240 V AC operating voltage
- IK10 impact rating for maximum protection

## Models

Standard models shown. Contact factory for other options.

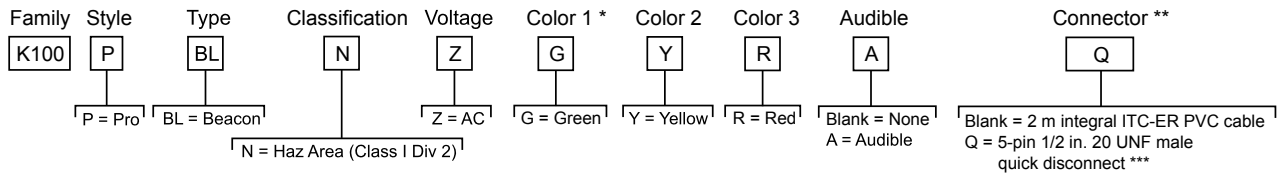

\* Optional color: Blue

\*\* Models with a quick disconnect require a mating cordset

\*\*\* Must be enclosed with a protected conduit or a suitable enclosure

## Installation Instructions

### Ex/HazLoc Applications

#### WARNING:



- **Explosive Atmospheres/Hazardous Locations**
- It is the user's responsibility to ensure that all local, state, and national laws, rules, codes, or regulations relating to the installation and use of this device in any particular application are satisfied. This device must be installed by a Qualified Person<sup>(1)</sup>, in accordance with this document and applicable regulations.

#### WARNING:



- **Explosion Hazard**
- Do not disconnect equipment unless the power has been switched off or the area is known to be non-hazardous.

#### CAUTION:



- **Electrostatic Discharge (ESD) Special Conditions for Safe Use**
- Parts of the enclosure are non-conducting and can generate an ignition-capable level of ESD.
- Clean the equipment with only a damp cloth.

#### General Notes and Conditions for Use

- See Specifications and Wiring Diagrams for important information concerning entity parameters, permissible locations, electrical connections and certifications.
- In addition to the warning above concerning user responsibility, the installation must comply with the following:
  - All installations must comply with all manufacturer's instructions.

<sup>(1)</sup> A Qualified Person is a person who, by possession of a recognized degree or certificate of professional training, or who, by extensive knowledge, training and experience, has successfully demonstrated the ability to solve problems relating to the subject matter and work.



- All applicable wiring methods in accordance with the relevant local regulations and the authority having jurisdiction.
- U.S. Installations: The relevant requirements of the National Electric Code® (ANSI/NFPA-70 NEC®).
- Canadian Installations: The relevant requirements of the Canadian Electrical Code (CSA C22.1).
- Do not attempt any repairs to this device; it contains no field-replaceable parts or components. Tampering and/or replacement with non-factory components may adversely affect the safe use of the system.
- The nonconducting materials of this device may be susceptible to ignition-capable level of electrostatic charging and precautions must be taken to avoid this. The user/installer shall ensure that the equipment is not installed in a location where it may be subjected to external conditions (such as high-pressure steam) which are conducive to creating a build-up of electrostatic charges.
- Clean with a damp cloth only.
- If the equipment is likely to come into contact with aggressive substances<sup>(1)</sup>, then it is the responsibility of the user to take suitable precautions<sup>(2)</sup> that prevent it from being adversely affected, thus ensuring that the type of protection is not compromised.
- The ingress protection (IP rating) of enclosures/panels may be invalidated by the installation of the beacon. The installation of the beacon in a particular enclosure/panel is subject to the evaluation/acceptance of the authority having jurisdiction.
- Models with integral quick-disconnect (QD) connectors:
  - Use recommended Banner cordsets (see "[Cordsets](#)" on page 5), or suitable quick-disconnect cordsets with threaded retaining nut (see "[Specifications](#)" on page 3). The cordset must be securely fastened using the quick-disconnect retaining nut to prevent disconnection. Maximum connector torque: 6 ft-lbs.
  - Must be installed such that the connector is protected from impact and unauthorized disconnection. The method of protection can include conduit (e.g. pole, pendent), enclosed raceway, a listed enclosure suitable for the intended use, and/or by inaccessible location that excludes possible impact damage.

## Wiring



An "X" denotes an active input.

For example: When Input 1 and Input 3 are both active, the indicator will be Color 1 Flashing at 1 Hz.

### Default Configuration

Wiring				Operating Mode/Function	
Brown (Input 1)	Blue (Input 2)	Black (Input 3)	Gray (Input 4)	Non-Audible	Audible
X				Color 1 Steady	Color 1 Steady
	X			Color 2 Steady	Color 2 Steady
		X		Color 3 Steady	Color 3 Steady
X		X		Color 1 Flashing at 1 Hz	Color 1 Flashing at 1 Hz
X	X			Color 2 Flashing at 1 Hz	Color 2 Flashing at 1 Hz
	X	X		Color 3 Flashing at 1 Hz	Color 3 Flashing at 1 Hz
X	X	X		Color 3, 3-pulse Strobe	Color 3, 3-pulse Strobe
			X	Off	Audible Steady, Frequency 2.5 KHz, Volume High
X			X	Color 1 Steady	Color 1 Steady, Audible Steady, Frequency 2.5 KHz, Volume High
	X		X	Color 2 Steady	Color 2 Steady, Audible Steady, Frequency 2.5 KHz, Volume High
		X	X	Color 3 Steady	Color 3 Steady, Audible Steady, Frequency 2.5 KHz, Volume High
X		X	X	Color 1 Flashing at 1 Hz	Color 1 Flashing at 1 Hz, Audible Steady, Frequency 2.5 KHz, Volume High
X	X		X	Color 2 Flashing at 1 Hz	Color 2 Flashing at 1 Hz, Audible Steady, Frequency 2.5 KHz, Volume High
	X	X	X	Color 3 Flashing at 1 Hz	Color 3 Flashing at 1 Hz, Audible Steady, Frequency 2.5 KHz, Volume High
X	X	X	X	Color 3, 3-pulse Strobe	Color 3, 3-pulse Strobe, Audible Steady, Frequency 2.5 KHz, Volume High

<sup>(1)</sup> Aggressive substances—for example, acidic liquids or gases that may attack metals, or solvents that may affect polymeric materials.

<sup>(2)</sup> Suitable precaution—for example, regular checks as part of routine inspections or establishing from the materials data sheet that is resistant to specific chemicals.

## Specifications

### Supply Protection Circuitry

Protected against reverse polarity and transient voltages

### Leakage Current Immunity

400  $\mu$ A

The use of relay output PLC is recommended since there is no leakage current. Solid state output PLCs often have leakage current above 1 mA and, therefore, turn the light on in the off state. To counteract the leakage current, a shunt resistor must be used. A resistor must be applied from the neutral wire of the device to the hot wire of each channel of the device.

### Indicator Response Time

On Response: 350 ms (maximum)

Off Response: 20 ms (maximum)

### Audible Characteristics

Sound Intensity at 2.5 KHz, at 1 m (typical):

Low volume setting: 93 dB

Medium volume setting: 96 dB

High volume setting: 101 dB

### Construction

Base, Dome, and Nut: Polycarbonate

### Operating Conditions

-40 °C to +60 °C (-40 °F to +140 °F)

90% at +50 °C maximum relative humidity (non-condensing)

Storage Temperature: -40 °C to +70 °C (-40 °F to +158 °F)

### Connections

Integral 5-pin 1/2 in. 20UNF male quick-disconnect connector or 2 m (6.5 ft) integral ITC-ER PVC-jacketed cable, depending on model

Models with a quick disconnect require a mating cordset

Connecting 5-pin M12 quick-disconnect cordsets (see "[Cordsets](#)" on page 5): Female single-ended Multiconductor cable (at minimum): UL Style 2517, 24 AWG wire, rated  $\geq$  80 °C; M12 quick-disconnect connector: per IEC 61076-2-101, must have threaded M12 x 1 retaining nut

### Mounting

M36 by 2.0 threaded base, maximum torque 5.0 N·m (44 inch-lbf)

Interior 3/4-14 NPT Thread

Mounting nut included

### Adjacent Unit Mounting Separation Distance

Minimum: 0 in (mounted with unit flanges touching)

### Approvals

NEC and CEC (cULus)

- Gas and Vapors: Class I Div 2 Groups ABCD T4
- Dust and Fibers/flyings: Class II Div 2 Groups FG T6; Class III Div 1 and Div 2 T6

### Maximum Input Power

Light Only: 12.1 W

Light and Audible: 13.7 W

### Vibration and Mechanical Shock

Meets IEC 60068-2-6 requirements (Vibration: 10 Hz to 55 Hz, 1.0 mm amplitude, 5 minutes sweep, 30 minutes dwell)

Meets IEC 60068-2-27 requirements (Shock: 30G 11 ms duration, half sine wave)

Impact: IK10 (60068-2-75)

### Environmental Rating

IP66, IP69K per DIN 40050-9, UL Type 4X

### LED Lifetime

Lumen maintenance L<sub>70</sub>

When operating within specifications, output decreases less than 30% after 42,000 hours

### Certifications



E530817

### Supply Voltage and Current

100 V AC to 240 V AC, 50 Hz to 60 Hz

Voltage	Maximum Current (mAAC at 60 Hz)			
	Steady On, Flash, or Strobe Function <sup>(1)</sup>		Rotate Function	
	Light Only	Light & Audible	Light Only	Light & Audible
100	140	154	96	100
230	78	85	62	68

### Default Indicator Characteristics

Color	Dominant Wavelength (nm) or Color Temperature (CCT)	Color Coordinates <sup>(2)</sup>		Lumen Output (Typical at 25 °C)
		x	y	
Green	528 nm	0.1603	0.6973	360
Yellow	589 nm	0.5557	0.4276	525
Red	625 nm	0.6999	0.2982	155
Blue	475 nm	0.1167	0.1121	165

Internal temperature compensation circuitry: Reduces the Lumen Output to decrease the unit internal operating temperature. The amount of reduction is dependent on the ambient operating temperature, supply voltage, color, and/or audible functions being utilized.

<sup>(1)</sup> Flash or Strobe Mode: Peak current, operating at 50% duty cycle or less.

<sup>(2)</sup> Refer to CIE 1931 chromaticity diagram or color chart, to show equivalent color with indicated color coordinates.

**Required Overcurrent Protection**



**WARNING:** Electrical connections must be made by qualified personnel in accordance with local and national electrical codes and regulations.

Overcurrent protection is required to be provided by end product application per the supplied table.

Overcurrent protection may be provided with external fusing or via Current Limiting, Class 2 Power Supply.

Supply wiring leads < 24 AWG shall not be spliced.

For additional product support, go to [www.bannerengineering.com](http://www.bannerengineering.com).

Supply Wiring (AWG)	Required Overcurrent Protection (A)	Supply Wiring (AWG)	Required Overcurrent Protection (A)
20	5.0	26	1.0
22	3.0	28	0.8
24	1.0	30	0.5

**Photometric Data**

Multiply the values shown in the chart by the maximum candela values in the Max. Candela table:  
Polar Candela Distribution

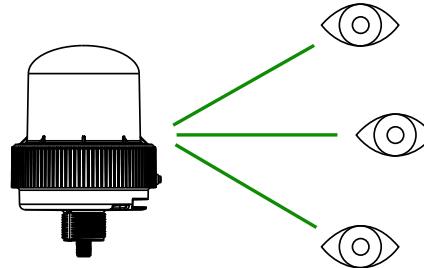
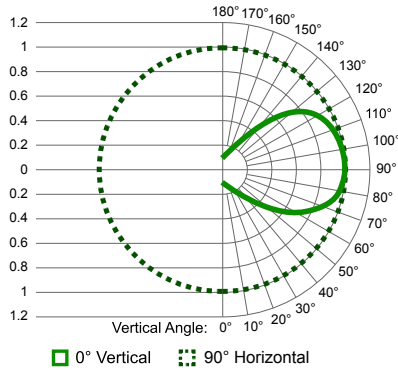

**Base Candela**

Green	46
Yellow	67
Red	20
Blue	21

**Candela Viewing Angle Example – Red**

Angle	Factor	Base <sup>(1)</sup>	Candela
120 (top view)	0.7	20	14
90 (side view)	1	20	20
60 (bottom view)	0.7	20	14

**Dimensions**

All measurements are listed in millimeters [inches], unless noted otherwise.

<sup>(1)</sup> Red shown. See Base Candela table.

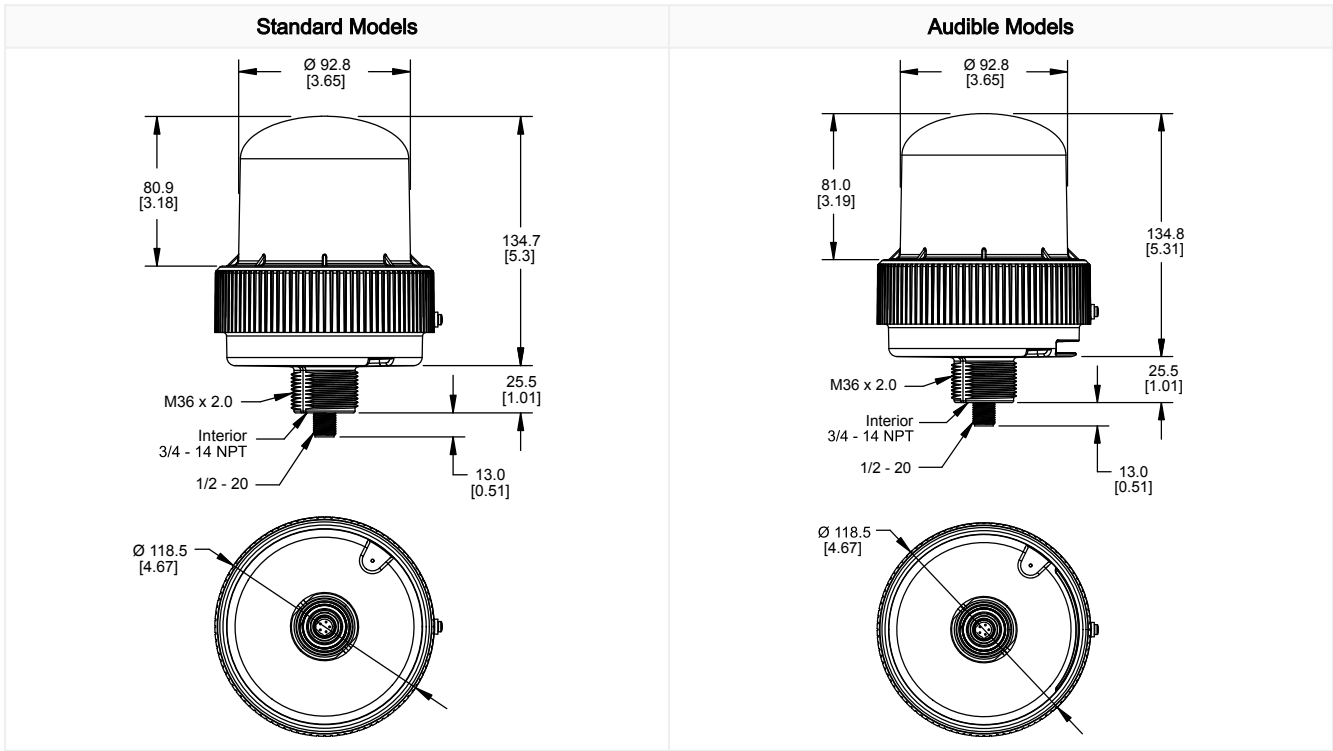

## Accessories

### Cordsets

All measurements are listed in millimeters, unless noted otherwise.



5-Pin 1/2-in Dual Key Cordsets—Single Ended				
Model	Length	Style	Dimensions	Pinout
MQAC2-506	2 m (6.56 ft)	Straight		
MQAC2-515	5 m (16.4 ft)			
MQAC2-530	9.14 m (30 ft)			

1 = Brown  
 2 = Blue  
 3 = White  
 4 = Black  
 5 = Gray

### Brackets

<p><b>LMB36RA</b></p> <ul style="list-style-type: none"> <li>Indicator light right-angle mounting</li> <li>36 mm mounting hole</li> <li>Stainless steel</li> </ul>	
--	--

## Elevated Mount System

Model			Features	Components
Black Anodized Aluminum ¼ in. NPT	Black Anodized Aluminum ½ in. NPT	Clear Anodized Aluminum ½ in. NPT		
<b>SOP-E34-150A</b> 150 mm (6 in) long	<b>SOP-E12-150A</b> 150 mm (6 in) long	<b>SOP-E12-150AC</b> 150 mm (6 in) long	<ul style="list-style-type: none"> <li>Elevated-use stand-off pipe</li> <li>Black anodized aluminum or clear anodized aluminum surface</li> <li>Threaded at both ends</li> <li>Compatible with most industrial environments</li> </ul>	
<b>SOP-E34-300A</b> 300 mm (12 in) long	<b>SOP-E12-300A</b> 300 mm (12 in) long	<b>SOP-E12-300AC</b> 300 mm (12 in) long		
<b>SOP-E34-600A</b> 600 mm (24 in) long	<b>SOP-E12-600A</b> 600 mm (24 in) long	—		
<b>SOP-E34-900A</b> 900 mm (36 in) long	<b>SOP-E12-900A</b> 900 mm (36 in) long	<b>SOP-E12-900AC</b> 900 mm (36 in) long		
<b>SA-M36E12</b>			<ul style="list-style-type: none"> <li>Adapter from M36 thread to 12-14 NPSM thread</li> <li>Streamlined black plastic mounting base adapter/cover</li> <li>Drilled hole</li> </ul>	
<b>SA-M36SOP</b>			<ul style="list-style-type: none"> <li>M36 thread adapter with clearance for ¾ pipe mount</li> <li>Streamlined black plastic mounting base adapter/cover</li> <li>Drilled hole</li> </ul>	

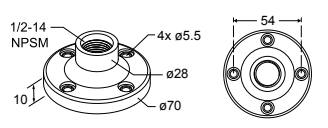
Pipe Mounting Flange			
Model	Features	Construction	
<b>SA-F12</b>	<ul style="list-style-type: none"> <li>Elevated-use stand-off pipes (½ in, NPSM/DN15)</li> <li>M5 mounting hardware and nitrile gasket included</li> </ul>	Die-cast zinc base with black paint	

## Banner Engineering Corp Limited Warranty

Banner Engineering Corp. warrants its products to be free from defects in material and workmanship for one year following the date of shipment. Banner Engineering Corp. will repair or replace, free of charge, any product of its manufacture which, at the time it is returned to the factory, is found to have been defective during the warranty period. This warranty does not cover damage or liability for misuse, abuse, or the improper application or installation of the Banner product.

**THIS LIMITED WARRANTY IS EXCLUSIVE AND IN LIEU OF ALL OTHER WARRANTIES WHETHER EXPRESS OR IMPLIED (INCLUDING, WITHOUT LIMITATION, ANY WARRANTY OF MERCHANTABILITY OR FITNESS FOR A PARTICULAR PURPOSE), AND WHETHER ARISING UNDER COURSE OF PERFORMANCE, COURSE OF DEALING OR TRADE USAGE.**

This Warranty is exclusive and limited to repair or, at the discretion of Banner Engineering Corp., replacement. **IN NO EVENT SHALL BANNER ENGINEERING CORP. BE LIABLE TO BUYER OR ANY OTHER PERSON OR ENTITY FOR ANY EXTRA COSTS, EXPENSES, LOSSES, LOSS OF PROFITS, OR ANY INCIDENTAL, CONSEQUENTIAL OR SPECIAL DAMAGES RESULTING FROM ANY PRODUCT DEFECT OR FROM THE USE OR INABILITY TO USE THE PRODUCT, WHETHER ARISING IN CONTRACT OR WARRANTY, STATUTE, TORT, STRICT LIABILITY, NEGLIGENCE, OR OTHERWISE.**

Banner Engineering Corp. reserves the right to change, modify or improve the design of the product without assuming any obligations or liabilities relating to any product previously manufactured by Banner Engineering Corp. Any misuse, abuse, or improper application or installation of this product or use of the product for personal protection applications when the product is identified as not intended for such purposes will void the product warranty. Any modifications to this product without prior express approval by Banner Engineering Corp will void the product warranties. All specifications published in this document are subject to change; Banner reserves the right to modify product specifications or update documentation at any time. Specifications and product information in English supersede that which is provided in any other language. For the most recent version of any documentation, refer to: [www.bannerengineering.com](http://www.bannerengineering.com).

For patent information, see [www.bannerengineering.com/patents](http://www.bannerengineering.com/patents).