

DATASHEET

UJ3N120065K3S

1200V-66mΩ SiC Normally-on JFET

Rev. A, November 2019

Description

UnitedSiC offers the high-performance G3 SiC normally-on JFET transistors. This series exhibits ultra-low on resistance ($R_{DS(ON)}$) and gate charge (Q_G) allowing for low conduction and switching loss. The device normally-on characteristics with low $R_{DS(ON)}$ at $V_{GS} = 0V$ is also ideal for current protection circuits without the need for active control, as well as for cascode operation.

Features

- ◆ Typical on-resistance $R_{DS(on),typ}$ of 66mΩ
- ◆ Voltage controlled
- ◆ Maximum operating temperature of 175°C
- ◆ Extremely fast switching not dependent on temperature
- ◆ Low gate charge
- ◆ Low intrinsic capacitance
- ◆ RoHS compliant

Typical applications

- ◆ Over Current Protection Circuits
- ◆ DC-AC Inverters
- ◆ Switch mode power supplies
- ◆ Power factor correction modules
- ◆ Motor drives
- ◆ Induction heating

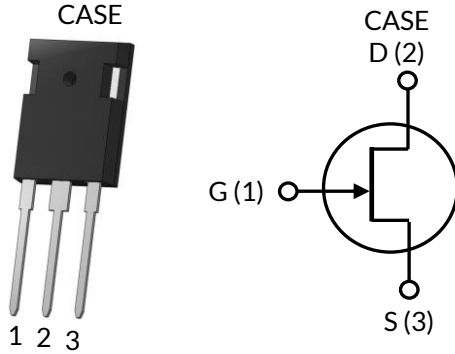

Part Number	Package	Marking
UJ3N120065K3S	TO-247-3L	UJ3N120065K3S



Maximum Ratings

Parameter	Symbol	Test Conditions	Value	Units
Drain-source voltage	V_{DS}		1200	V
Gate-source voltage	V_{GS}	DC	-20 to +3	V
		AC ¹	-30 to +20	V
Continuous drain current ²	I_D	$T_C = 25^\circ\text{C}$	34	A
		$T_C = 100^\circ\text{C}$	25	A
Pulsed drain current ³	I_{DM}	$T_C = 25^\circ\text{C}$	90	A
Power dissipation	P_{tot}	$T_C = 25^\circ\text{C}$	254	W
Maximum junction temperature	$T_{J,max}$		175	$^\circ\text{C}$
Operating and storage temperature	T_J, T_{STG}		-55 to 175	$^\circ\text{C}$
Max. lead temperature for soldering, 1/8" from case for 5 seconds	T_L		250	$^\circ\text{C}$

1. +20V AC rating applies for turn-on pulses <200ns applied with external $R_G > 1\Omega$.

2. Limited by $T_{J,max}$

3. Pulse width t_p limited by $T_{J,max}$

Thermal Characteristics

Parameter	Symbol	Test Conditions	Value			Units
			Min	Typ	Max	
Thermal resistance, junction-to-case	$R_{\theta JC}$			0.45	0.59	$^\circ\text{C/W}$

Electrical Characteristics ($T_J = +25^\circ\text{C}$ unless otherwise specified)

Typical Performance - Static

Parameter	Symbol	Test Conditions	Value			Units
			Min	Typ	Max	
Drain-source breakdown voltage	BV_{DS}	$V_{GS}=-20\text{V}, I_D=1\text{mA}$	1200			V
Total drain leakage current	I_{DSS}	$V_{DS}=1200\text{V}, V_{GS}=-20\text{V}, T_J=25^\circ\text{C}$		5	30	μA
		$V_{DS}=1200\text{V}, V_{GS}=-20\text{V}, T_J=175^\circ\text{C}$		56		
Total gate leakage current	I_{GSS}	$V_{GS}=-20\text{V}, T_J=25^\circ\text{C}$		0.1	50	μA
		$V_{GS}=-20\text{V}, T_J=175^\circ\text{C}$		1		μA
Drain-source on-resistance	$R_{DS(on)}$	$V_{GS}=2\text{V}, I_D=10\text{A}, T_J=25^\circ\text{C}$		55		m Ω
		$V_{GS}=0\text{V}, I_D=10\text{A}, T_J=25^\circ\text{C}$		66	90	
		$V_{GS}=2\text{V}, I_D=10\text{A}, T_J=175^\circ\text{C}$		122		
		$V_{GS}=0\text{V}, I_D=10\text{A}, T_J=175^\circ\text{C}$		142		
Gate threshold voltage	$V_{G(th)}$	$V_{DS}=5\text{V}, I_D=35\text{mA}$	-9.3	-6.6	-4.7	V
Gate resistance	R_G	f=1MHz, open drain		2.6		Ω

Typical Performance - Dynamic

Parameter	Symbol	Test Conditions	Value			Units
			Min	Typ	Max	
Input capacitance	C_{iss}	$V_{DS}=100V, V_{GS}=-20V$ $f=100kHz$		1008		pF
Output capacitance	C_{oss}			100		
Reverse transfer capacitance	C_{rss}			95		
Effective output capacitance, energy related	$C_{oss(er)}$	$V_{DS}=0V$ to 800V, $V_{GS}=-20V$		56		pF
C_{oss} stored energy	E_{oss}	$V_{DS}=800V, V_{GS}=-20V$		18		μJ
Total gate charge	Q_G	$V_{DS}=800V, I_D=25A,$ $V_{GS} = -18V$ to 0V		114		nC
Gate-drain charge	Q_{GD}			75		
Gate-source charge	Q_{GS}			16		
Turn-on delay time	$t_{d(on)}$	$V_{DS}=800V, I_D=25A,$ Gate Driver = -18V to 0V, $R_G=1\Omega,$ Inductive Load, FWD: UJ2D1215T $T_J=25^\circ C$		32		ns
Rise time	t_r			43		
Turn-off delay time	$t_{d(off)}$			19		
Fall time	t_f			16		
Turn-on energy	E_{ON}			785		
Turn-off energy	E_{OFF}		150		μJ	
Total switching energy	E_{TOTAL}		935			
Turn-on delay time	$t_{d(on)}$	$V_{DS}=800V, I_D=25A,$ Gate Driver = -18V to 0V, $R_G=1\Omega,$ Inductive Load, FWD: UJ2D1215T $T_J=150^\circ C$		28		ns
Rise time	t_r			42		
Turn-off delay time	$t_{d(off)}$			18		
Fall time	t_f			15		
Turn-on energy	E_{ON}			730		
Turn-off energy	E_{OFF}		146		μJ	
Total switching energy	E_{TOTAL}		876			

Typical Performance Diagrams

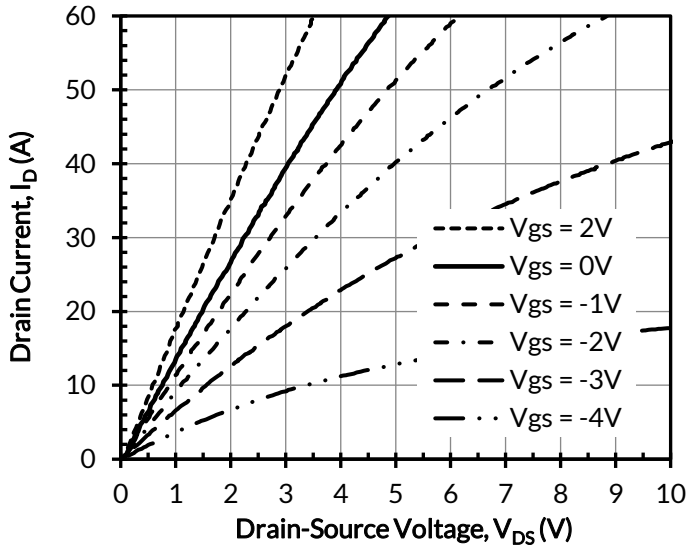

Figure 1. Typical output characteristics at $T_j = -55^\circ\text{C}$, $t_p < 250\mu\text{s}$

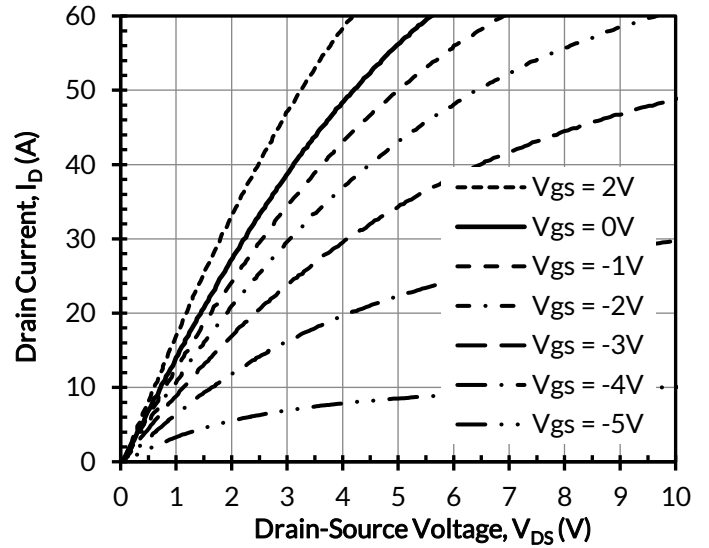

Figure 2. Typical output characteristics at $T_j = 25^\circ\text{C}$, $t_p < 250\mu\text{s}$

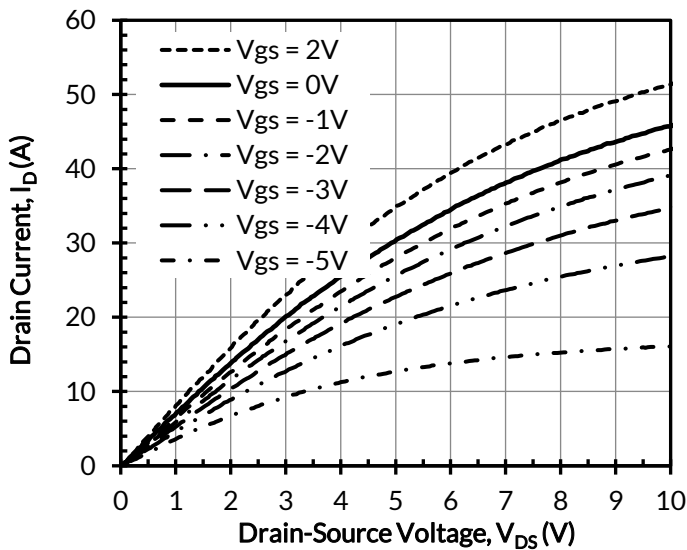

Figure 3. Typical output characteristics at $T_j = 175^\circ\text{C}$, $t_p < 250\mu\text{s}$

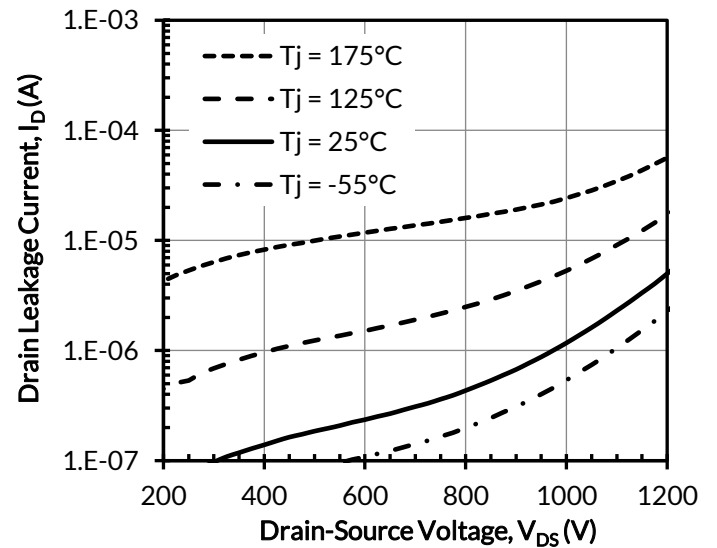

Figure 4. Typical drain-source leakage at $V_{GS} = -20\text{V}$

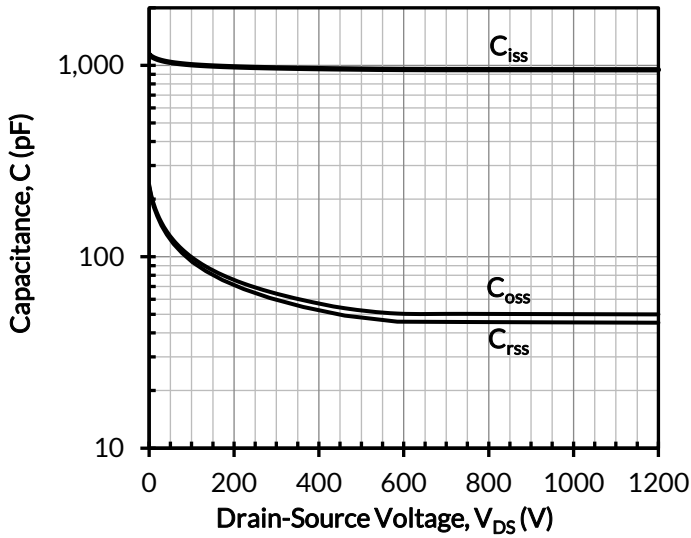

Figure 5. Typical capacitances at $f = 100\text{kHz}$ and $V_{GS} = -20\text{V}$

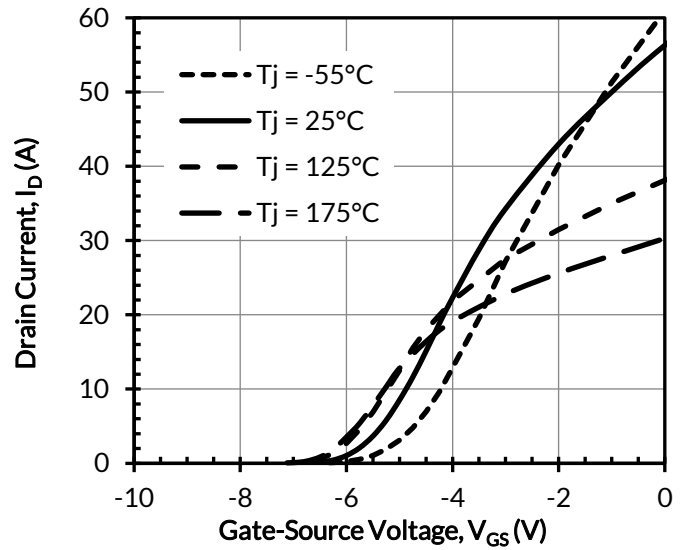

Figure 6. Typical transfer characteristics at $V_{DS} = 5\text{V}$

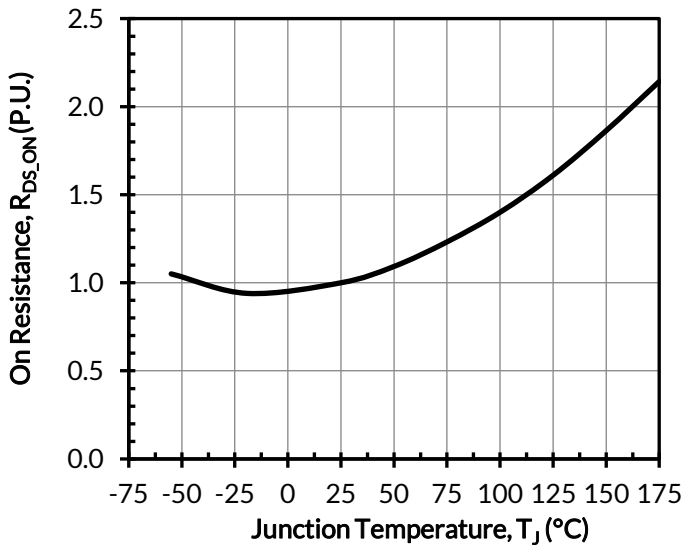

Figure 7. Normalized on-resistance vs. temperature at $V_{GS} = 0\text{V}$ and $I_D = 10\text{A}$

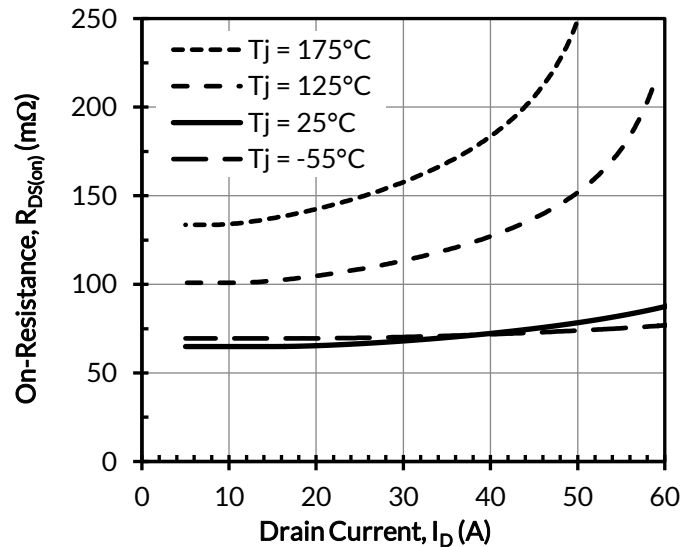

Figure 8. Typical drain-source on-resistances at $V_{GS} = 0\text{V}$

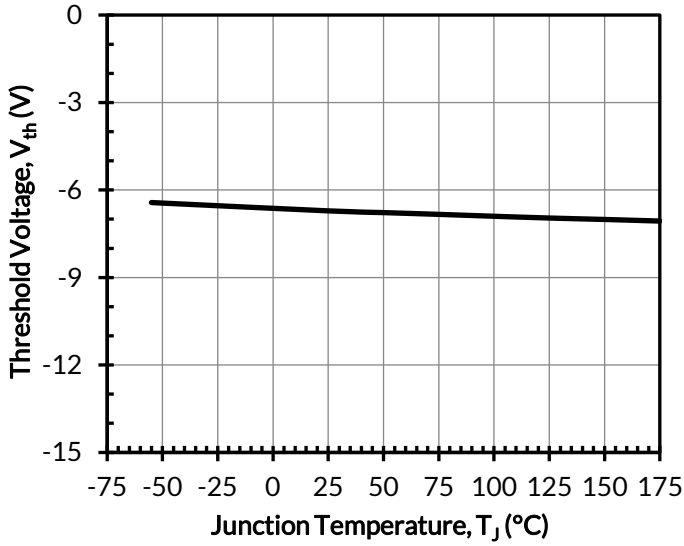

Figure 9. Threshold voltage vs. junction temperature at $V_{DS} = 5V$ and $I_D = 35mA$

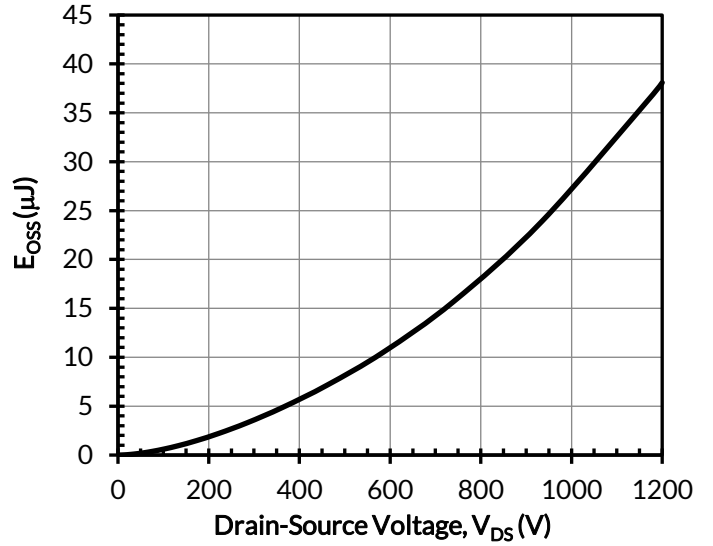

Figure 10. Typical stored energy in C_{OSS} at $V_{GS} = -20V$

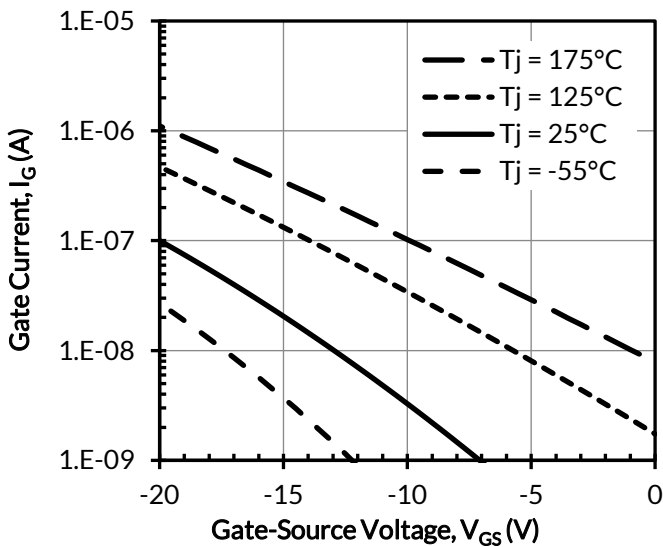

Figure 11. Typical gate leakage at $V_{DS} = 0V$

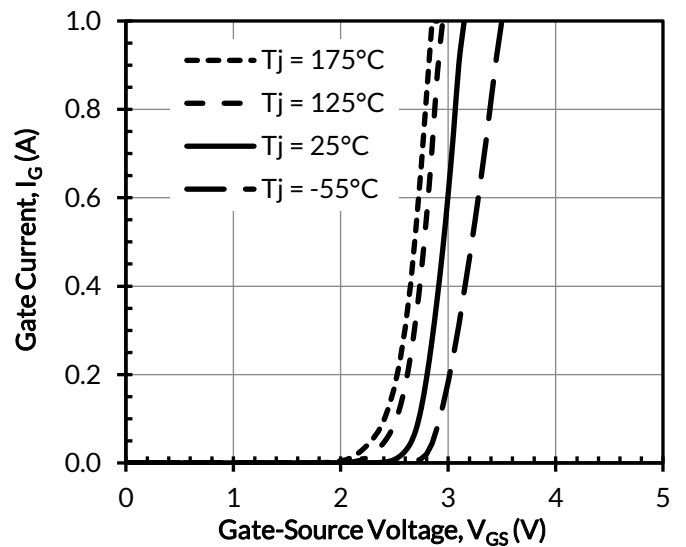

Figure 12. Typical gate forward current at $V_{DS} = 0V$

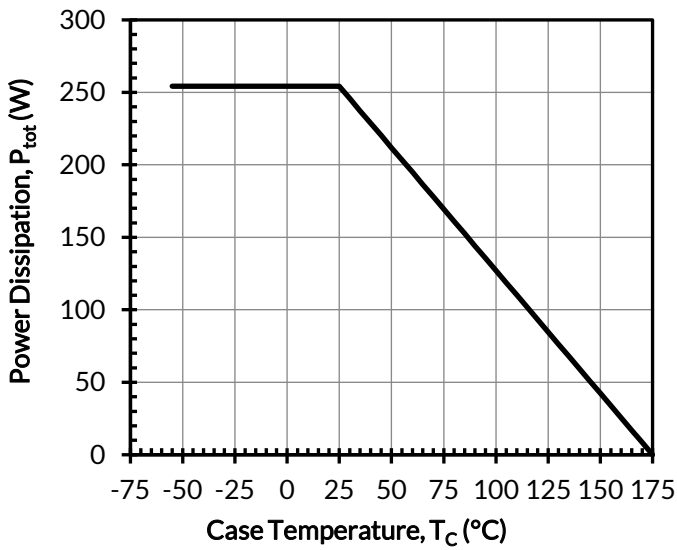

Figure 13. Total power Dissipation

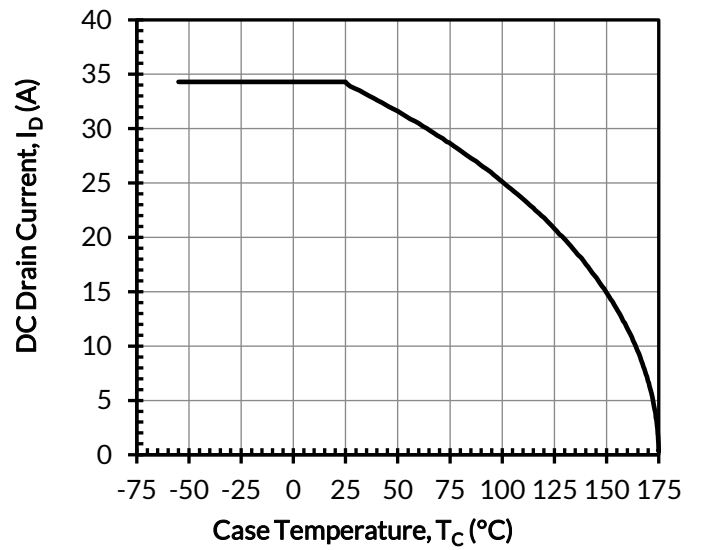

Figure 14. DC drain current derating

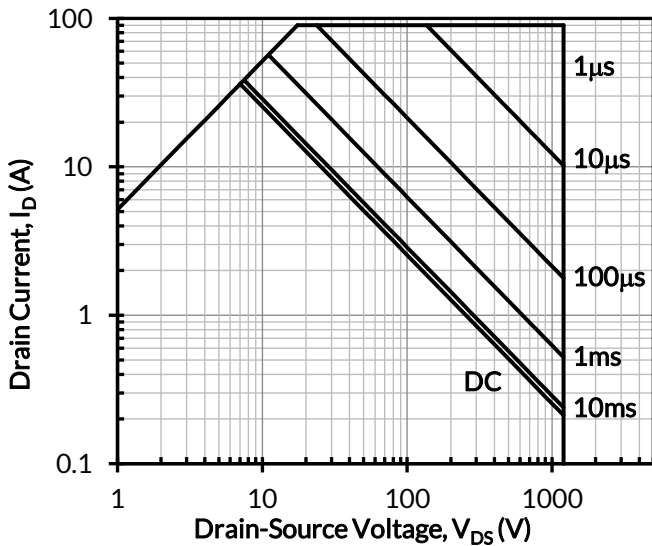

Figure 15. Safe operation area at $T_C = 25^\circ\text{C}$, Parameter t_p

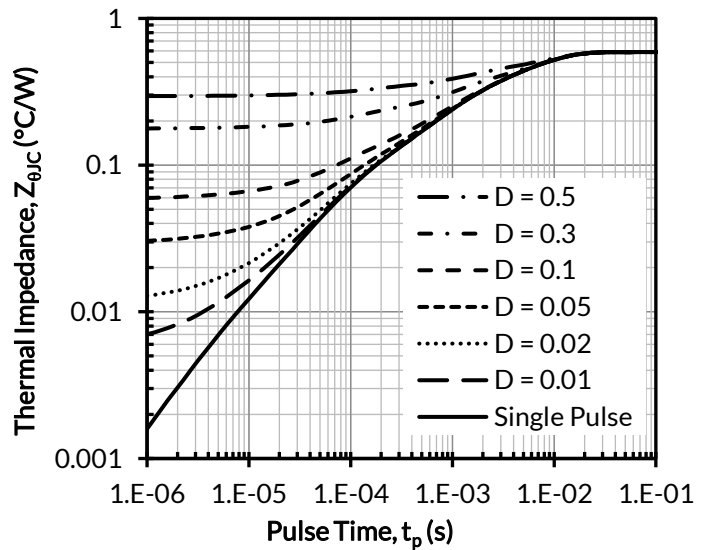

Figure 16. Maximum transient thermal impedance

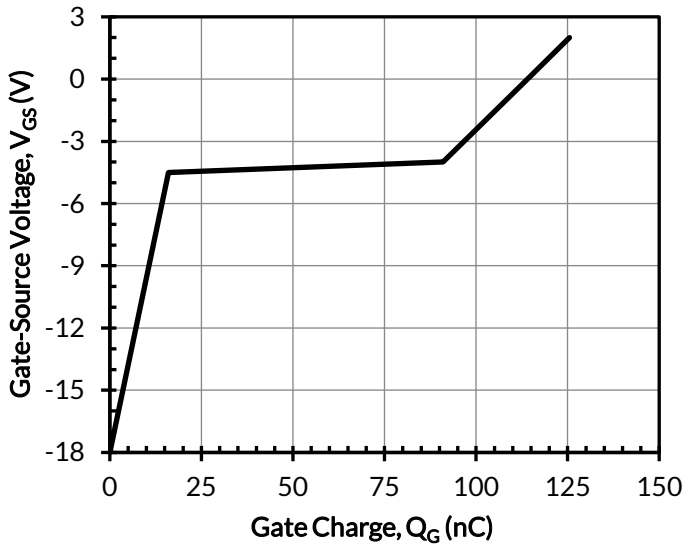

Figure 17. Typical gate charge at $V_{DS} = 800V$ and $I_D = 25A$

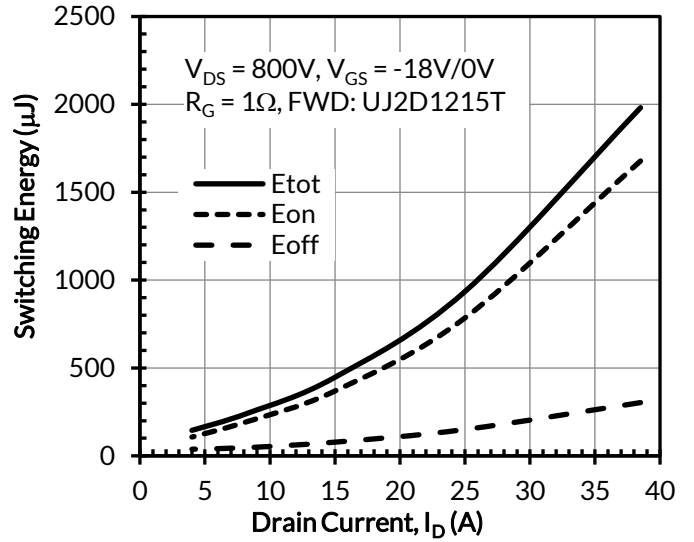

Figure 18. Clamped inductive switching energy vs. drain current at $T_J = 25^\circ C$

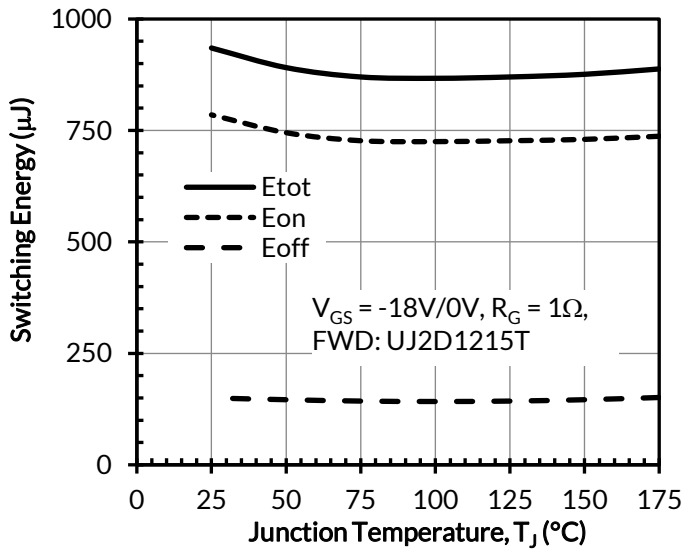

Figure 19. Clamped inductive switching energy vs. junction temperature at $V_{DS} = 800V$ and $I_D = 25A$

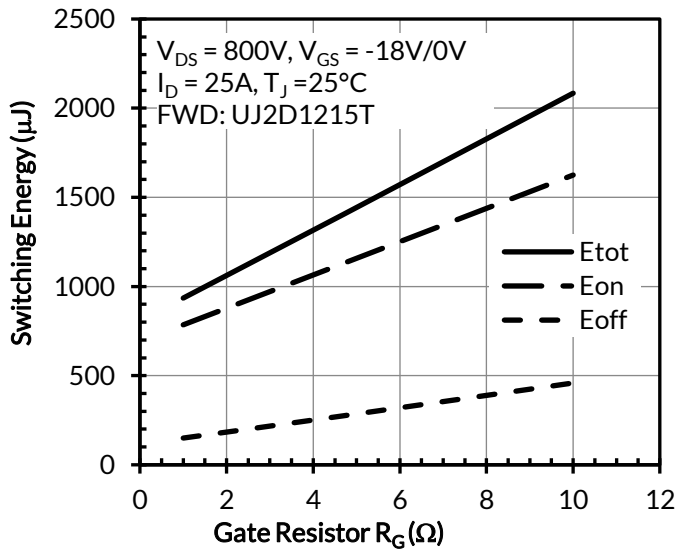

Figure 20. Clamped inductive switching energy vs. gate resistor R_G

Disclaimer

UnitedSiC reserves the right to change or modify any of the products and their inherent physical and technical specifications without prior notice. UnitedSiC assumes no responsibility or liability for any errors or inaccuracies within.

Information on all products and contained herein is intended for description only. No license, express or implied, to any intellectual property rights is granted within this document.

UnitedSiC assumes no liability whatsoever relating to the choice, selection or use of the UnitedSiC products and services described herein.