

## OTi DALI 50/220...240/1A4 LT2 FAN

OPTOTRONIC Intelligent – DALI LT2 | Compact constant current LED driver – Dimmable



### Product family features

- Supply voltage: 220...240 V
- Line frequency: 0 Hz | 50 Hz | 60 Hz
- Line voltage: 198...264 V
- Safety according to EN 61347-1, 61347-2-3, 61347-2-13, 62384
- RI suppression: to EN 55015/CISPR 15
- Line harmonics according to EN 61000-3-2
- Immunity according to EN 61547
- Lifetime: up to 100,000 h
- Type of protection: IP20
- Independent connection via through-looping (except OTi DALI 15)

### Product family benefits

- Versatile DALI window driver due to flexible output characteristic
- Very high efficiency
- Protection of the system thanks to thermal management and Smart Control
- High-quality dimming of 1...100 % by amplitude dimming

### Versatile scope of application due to OSRAM DALI Technology:

- Easy to use in corridors and restrooms because of three-level Corridor function
- Touch DIM application: easy to control via pushbutton or sensor
- Energy efficient Touch DIM operation due to automatic switch-off at sufficient residual light
- Suitable for emergency Installations (acc. to EN 60598-2-22 and IEC 61347-2-13, appendix J) thanks to DC detection (0 Hz, pulsating DC), on/off switchable
- Feedback of power consumption and operating hours (Fit for SMART GRID)
- Suitable for buildings according to EPBD/BREEAM/LEED due to automatic Constant Lumen Output setting



## Product datasheet

---

### Areas of application

- Installation in emergency lighting systems according to IEC 61347-2-13, appendix J
- Suitable for use in luminaires with flexible current setting (DALI, CLO, LEDset)
- Suitable for indoor SELV installations
- Suitable for luminaires of protection classes I and II
- Suitable for downlights, spotlights and LED panels
- Installation via Cable Clamp Kit possible (depending on version of product)

## Technical data

### Electrical data

Nominal input voltage	220...240 V
Mains frequency	0/50/60 Hz
Input voltage AC	198...264 V <sup>1)</sup>
Input voltage DC	176...276 V
Total harmonic distortion	< 10 % <sup>2)</sup>
Power factor $\lambda$	0.81C...0.97
Efficiency in full-load	91 % <sup>3)</sup>
Device power loss	7.5 W
Inrush current	30 A <sup>4)</sup>
Max. ECG no. on circuit breaker 10 A (B)	12
Max. ECG no. on circuit breaker 16 A (B)	20
Max. ECG no. on circuit breaker 25 A (B)	-
Surge capability (L/N-Ground)	2 kV <sup>5)</sup>
Surge capability (L-N)	1 kV
Nominal output voltage	15...54 V <sup>6)</sup>
U-OUT (working voltage)	60 V
Nominal output current	600...1400 mA <sup>7)</sup>
Output current LEDset open	300 mA
Output current LEDset shorted	1050 mA
Default output current	1050 mA <sup>8)</sup>
Output current tolerance	±3 %
Output ripple current (100 Hz)	< 2 % <sup>9)</sup>
Output PSTLM	≤1
Output SVM	≤0.4
Nominal output power	55 W <sup>10)</sup>
Maximum output power	55 W
Power loss in stand-by mode	<0.15 W
Galvanic isolation primary/secondary	SELV
Current set	DALI / LEDset2
Galvanic isolation DALI/mains	Basic
Galvanic isolation DALI/output	SELV
Networked standby power	≤0.15 W <sup>3)</sup>

<sup>1)</sup> Permitted voltage range

<sup>2)</sup> At full load, 220...240 V, 50 Hz / see graphs

<sup>3)</sup> at 230 V, 50 Hz

<sup>4)</sup>  $t_{width} = 200 \mu s$  (measured at 50 %  $I_{peak}$ )

<sup>5)</sup> Functional Earth

## Product datasheet

- 6) Maximum 60 V
- 7)  $\pm 5\%$
- 8) LEDset deactivated
- 9) Ripple average at 100 Hz
- 10) Partial load 22...55 W

### Dimensions & weight

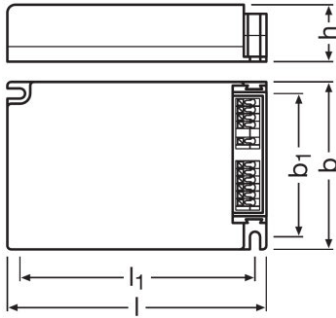

Mounting hole spacing, length	99.0 mm
Mounting hole spacing, width	64.0 mm
Product weight	180.00 g
Cable cross-section, input side	0.2...1.5 mm <sup>2</sup> <sup>1)</sup>
Cable cross-section, output side	0.2...1.5 mm <sup>2</sup> <sup>1)</sup>
Wire preparation length, input side	8.0...9.0 mm
Wire preparation length, output side	8.0...9.0 mm
Length	110.0 mm
Width	75.0 mm
Height	25.0 mm

<sup>1)</sup> Solid or flexible leads

### Colors & materials

Casing material	Plastic
-----------------	---------

### Temperatures & operating conditions

Ambient temperature range	-20...+50 °C
Maximum temperature at tc test point	80 °C <sup>1)</sup>
Max.housing temperature in case of fault	110 °C
Temperature range at storage	-25...85 °C
Permitted rel. humidity during operation	5...85 % <sup>2)</sup>

<sup>1)</sup> Maximum at the Tc-point

<sup>2)</sup> Maximum 56 days/year at 85 %

## Lifespan

<b>ECG lifetime</b>	50000 / 100000 h <sup>1)</sup>
---------------------	--------------------------------

<sup>1)</sup>  $T_c = 80^\circ\text{C}$ , 0.2% / 1,000 h failure rate /  $T_c = 70^\circ\text{C}$ , 0.1% / 1,000 h failure rate

## Capabilities

<b>Dimmable</b>	Yes
<b>Dimming interface</b>	DALI-2 / Touch DIM / Touch DIM Sensor
<b>Dimming range</b>	1...100 % <sup>1)</sup>
<b>Dimming method</b>	Amplitude Modulation
<b>Constant lumen function</b>	Programmable
<b>Overheating protection</b>	Automatic reversible
<b>Overload protection</b>	Automatic reversible
<b>Short-circuit protection</b>	Automatic reversible
<b>No-load proof</b>	Yes
<b>Intended for no-load operation</b>	No
<b>Max. cable length to lamp/LED module</b>	2.0 m <sup>2)</sup>
<b>Suitable for fixtures with prot. class</b>	I / II
<b>Suitable for emergency lighting</b>	Yes
<b>Type of connection, output side</b>	Push terminal
<b>Suitable for through-wiring</b>	Yes with optional cable clamp
<b>Programming interface</b>	DALI, LEDset
<b>Number of channels</b>	1
<b>DALI-2 Energy Data</b>	Yes <sup>3)</sup>
<b>DALI-2 Diagnostic Data</b>	Yes <sup>4)</sup>

<sup>1)</sup> For maximum nominal output current

<sup>2)</sup> Output wires must be routed as close as possible to each other

<sup>3)</sup> Acc. DALI part 252

<sup>4)</sup> Acc. DALI part 253

## Programming

<b>Tuner4TRONIC Field App</b>	No
<b>Programming device</b>	DALI / LEDset

## Programmable features

<b>Operating Current</b>	Yes
<b>Lamp Operating Time</b>	Yes
<b>Driver Guard</b>	No
<b>DALI Settings</b>	Yes
<b>Emergency Mode</b>	Yes

## Product datasheet

DALI-2 Luminaire Data	Yes <sup>1)</sup>
Configuration Lock	No
Soft Switch Off	Yes
Dim to Dark	No
TouchDIM + Sensor	Yes
Corridor Functionality	Yes
OEM Key	Yes

<sup>1)</sup> Acc. DALI part 251

### Certificates & standards

Approval marks – approval	ENEC 10 / VDE / EMC / EL / CE / DALI-2
Standards	Acc. to EN 61347-1/Acc. to EN 61347-2-13/Acc. to EN 55015/Acc. to EN 61547/Acc. to EN 61000-3-2/Acc. to EN 62384/Acc. to EN 62386/Acc. to IEC 62386-101:Ed2/Acc. to IEC 62386-102:Ed2/Acc. to IEC 62386-207:Ed1
Protection class	II
Type of protection	IP20



### Logistical data

Commodity code	850440839000
----------------	--------------









### Environmental information

Information according Art. 33 of EU Regulation (EC) 1907/2006 (REACH)	
Date of Declaration	14-04-2023
Primary Article Identifier	4052899488182
Candidate List Substance 1	Lead
CAS No. of substance 1	7439-92-1
Safe Use Instruction	The identification of the Candidate List substance is sufficient to allow safe use of the article.
Declaration No. in SCIP database	bb67ec73-9cf7-40a1-b713-ffb71366060b

### Download Data

File	
	User instruction OPTOTRONIC LED Power Supply
	Certificates OTI DALI 50 LT2 FAN CB DE1 59836 040320

## Product datasheet

	Certificates LED drivers EMC 40011668 300922
	Certificates OT ENEC 40038447 260623
	Declarations of conformity OTi DALI LT2 UK DoC 4281294 180221
	Declarations of conformity EATON(CEAG)-Conformity declaration AB42878_OTi_DALI_50_220-240_1A4_LT2_FAN
	Declarations of conformity INOTEC- Conformity declaration AB42878_OTi_DALI_50_220-240_1A4_LT2_FAN
	Declarations of conformity OTi DALI LT2 CE 3365628 200821
	CAD data 3-dim 491394_OTi DALI 50 LT2 FAN STEP 61119
	CAD data PDF 491393_OTi DALI 50 LT2 FAN CADPDF 61119
	CAD data PDF 491395_OTi DALI 50 LT2 FAN IGS 61119

### Ecodesign regulation information:

Intended for use with LED modules.

The forward voltage of the LED light source shall be within the defined operating window of the control gear in all operating conditions including dimming if applicable.

Separate control gear and light sources must be disposed of at certified disposal companies in accordance with Directive 2012/19/EU (WEEE) in the EU and with Waste Electrical and Electronic Equipment (WEEE) Regulations 2013 in the UK. For this purpose, collection points for recycling centres and take-back systems (CRSO) are available from retailers or private disposal companies, which accept separate control gear and light sources free of charge. In this way, raw materials are conserved and materials are recycled.

### Logistical Data

Product code	Product description	Packaging unit (Pieces/Unit)	Dimensions (length x width x height)	Volume	Gross weight
4052899488182	OTi DALI 50/220...240/1A4 LT2 FAN	Shipping carton box 20	389 mm x 234 mm x 72 mm	6.55 dm <sup>3</sup>	4118.00 g

The mentioned product code describes the smallest quantity unit which can be ordered. One shipping unit can contain one or more single products. When placing an order, for the quantity please enter single or multiples of a shipping unit.

### Accessories Optional

## Product datasheet

Product description	Accessory name	Accessory code
OTi DALI 50/220...240/1A4 LT2 FAN	OT CABLE CLAMP A-STYLE	▶ 4052899089570
OTi DALI 50/220...240/1A4 LT2 FAN	OT CABLE CLAMP A-STYLE TL	▶ 4052899325982

---

### Data privacy

This OSRAM driver can be configured using the Tuner4TRONIC software. This requires registering on [www.myosram.com](http://www.myosram.com) and downloading the Tuner4TRONIC software from the Internet. The Tuner4TRONIC software enables users to access and view the operational data of a luminaire or driver via the corresponding programming interfaces. A password key (Config Lock) must be set up in the driver via the Tuner4TRONIC software in order to control which users can access and view operational data. Follow the instructions for password setup. To grant an external person or company rights to access or view operational data, you can assign password keys. In this case, however, you are responsible for ensuring that the third party concerned takes notice of the information described here. However, OSRAM can read out operating data from devices for maintenance and service purposes even when a password key has been assigned. In individual cases, OSRAM will also use its access rights in order to optimize or improve driver hardware and driver functions. In accordance with data privacy principles, any user of operating data (luminaire manufacturers, third parties with access rights) must ensure that personal data (e.g. name, address, location IDs) are only merged with the prior written consent of the person (end user) concerned. The respective user of the operating data is responsible for providing evidence of consent.

---

### Disclaimer

— Subject to change without notice. Errors and omission excepted. Always make sure to use the most recent release.