

CONTINUOUS VOLTAGE SMD CRYSTAL OSCILLATOR

ASETDV

Request Samples



Check Inventory



ESD Sensitive



3.2 x 2.5 x 1.2mm

RoHS/RoHS II Compliant

MSL Level = 1

Features

- Continuous Vdd operation from 1.68 V ~ 3.63 V
- Low current consumption
- Standby (Power Down) function
- Output waveform CMOS
- Hermetically seam-sealed ceramic package

Applications

- Portable & wearable electronics
- Internet of Things (IoT)
- Consumer electronics
- Industrial control & automation
- Mobile communication

Electrical Specifications

Parameters	Min.	Typ.	Max.	Units	Notes
Frequency Range	9.6		60	MHz	
Operating Temperature Range	-40		+125	°C	See options
Storage Temperature Range	-55		+125	°C	
Overall Frequency Stability ^[Note 1]	-10		+10	ppm	See options
Supply Voltage (Vdd)	1.68		3.63	V	
Output Load			15	pF	CMOS
Output Voltage	V _{OH}	0.9*Vdd		V	
	V _{OL}		0.1*Vdd		
Aging 1 year @25°C± 3°C	-1.0		+1.0	ppm	
Symmetry @ ½ Vdd	45	50	55	%	
Start-up Time			10.0	ms	
Rise and Fall Time (Tr/Tf) @10%Vdd-90%Vdd, 15pF load	Vdd = 1.8V to 3.63V		5.0	ns	
	Vdd = 1.68V to 1.79V		8.0		
RMS Phase Jitter @25°C± 3°C (10 - 39MHz: 12kHz to 5MHz) (>39MHz: 12kHz to 20MHz)			1.0	ps	
Tri-state function	“1” (VIH≥0.7*Vdd) or Open: Oscillation; “0” (VIL<0.3*Vdd): No Oscillation/Hi Z			V	
Disable Current			10.0	µA	

Note 1:

Overall frequency stability includes initial frequency tolerance @25°C± 3°C and stability over the operating temperature range.



5101 Hidden Creek Ln Spicewood TX 78669
 Phone: 512-371-6159 | Fax: 512-351-8858
 For terms and conditions of sales, please visit:
www.abracon.com

REVISED: 06-19-23

ABRACON IS
 ISO9001-2015
 CERTIFIED

CONTINUOUS VOLTAGE SMD CRYSTAL OSCILLATOR

ASETDV

Request Samples



Check Inventory



ESD Sensitive



3.2 x 2.5 x 1.2mm
RoHS/RoHS II Compliant
 MSL Level = 1

Electrical Specifications *continued*

Parameters	Min.	Typ.	Max.	Units	Notes
Supply Current (I _{dd}) into 15pF Load @25°C± 3°C @ V _{dd} =3.3V			4.8	mA	9.60MHz to 20.00MHz
			5.5		20.01MHz to 30.00MHz
			6.0		30.01MHz to 40.00MHz
			7.0		40.01MHz to 50.00MHz
			8.0		50.01MHz to 60.00MHz
Supply Current (I _{dd}) into 15pF Load @25°C± 3°C @ V _{dd} =2.5V			4.3	mA	9.60MHz to 20.00MHz
			5.0		20.01MHz to 30.00MHz
			5.5		30.01MHz to 40.00MHz
			6.5		40.01MHz to 50.00MHz
			7.5		50.01MHz to 60.00MHz
Supply Current (I _{dd}) into 15pF Load @25°C± 3°C @ V _{dd} =1.8V			3.8	mA	9.60MHz to 20.00MHz
			4.5		20.01MHz to 30.00MHz
			5.0		30.01MHz to 40.00MHz
			6.0		40.01MHz to 50.00MHz
			7.0		50.01MHz to 60.00MHz

Typical Current Consumption (I_{dd}) vs. Supply Voltage (V_{dd}) Characteristics @25°C±3°C [Load=15pF]

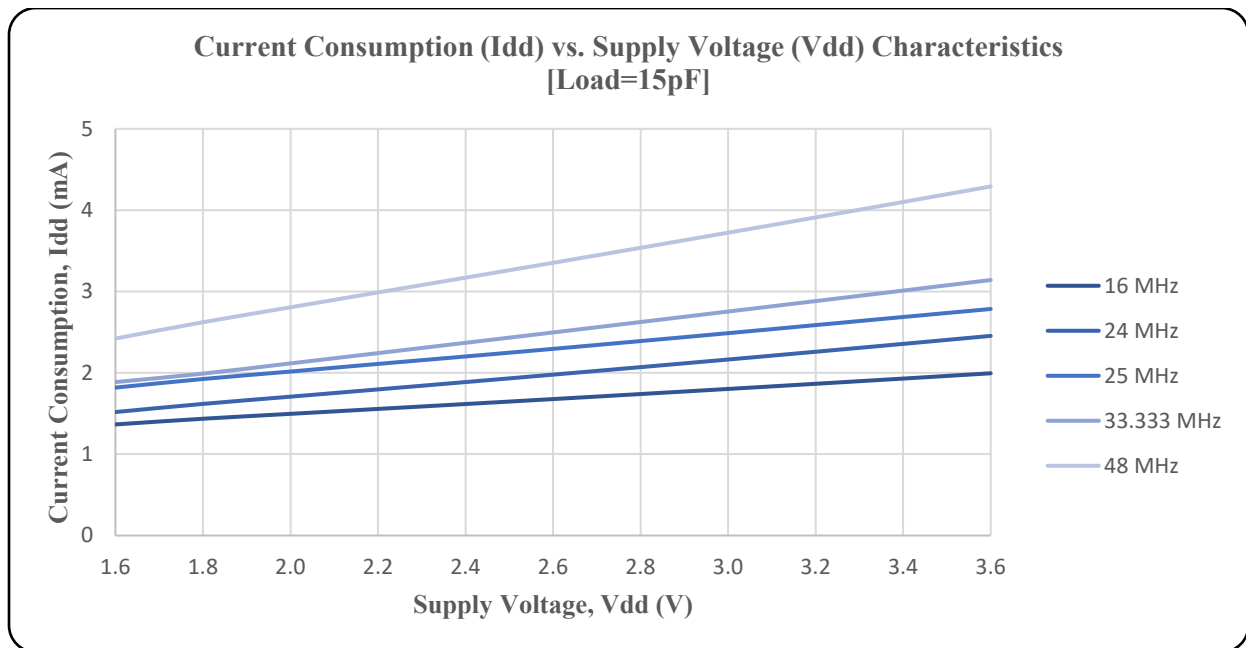

CONTINUOUS VOLTAGE SMD CRYSTAL OSCILLATOR

ASETDV

Request Samples



Check Inventory



ESD Sensitive



3.2 x 2.5 x 1.2mm
RoHS/RoHS II Compliant
 MSL Level = 1

Typical Frequency vs. Operating Temperature Characteristics @ Vdd = 2.5V [Load=15 pF]

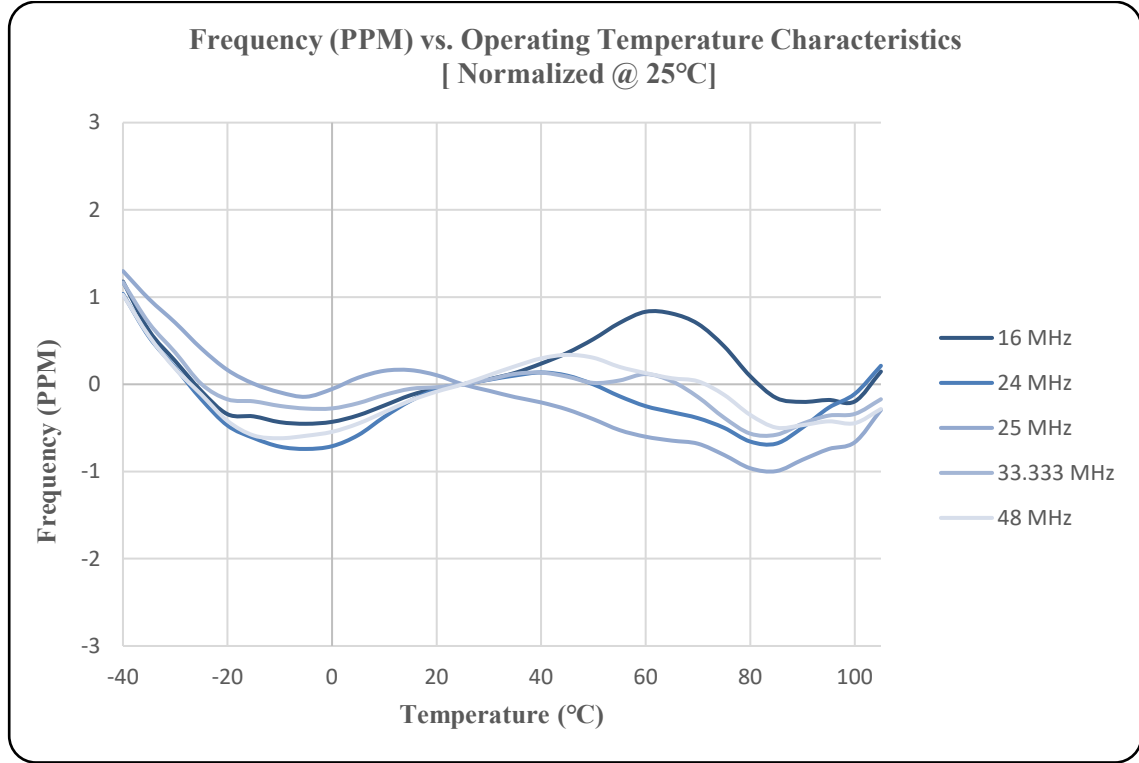

Part Identification

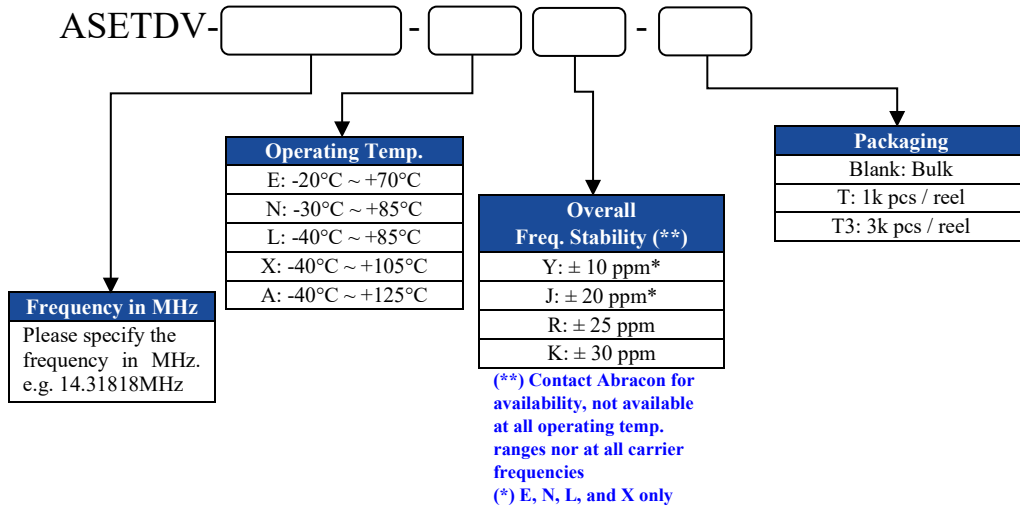

5101 Hidden Creek Ln Spicewood TX 78669
 Phone: 512-371-6159 | Fax: 512-351-8858
 For terms and conditions of sales, please visit:
www.abracon.com

REVISED: 06-19-23

ABRACON IS
 ISO9001-2015
 CERTIFIED

CONTINUOUS VOLTAGE SMD CRYSTAL OSCILLATOR

ASETDV

Request Samples



Check Inventory



ESD Sensitive



3.2 x 2.5 x 1.2mm
RoHS/RoHS II Compliant
MSL Level = 1

Mechanical Dimensions

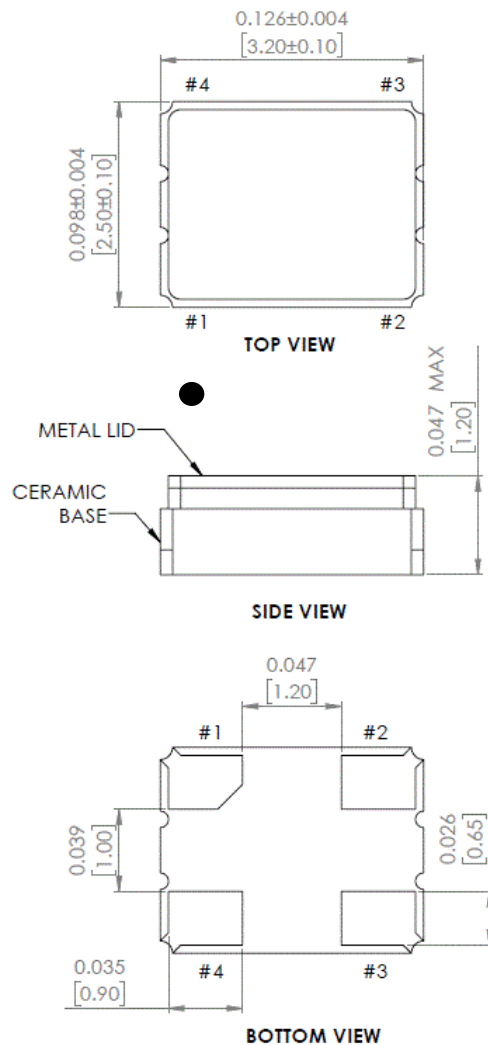

Recommended Land Pattern

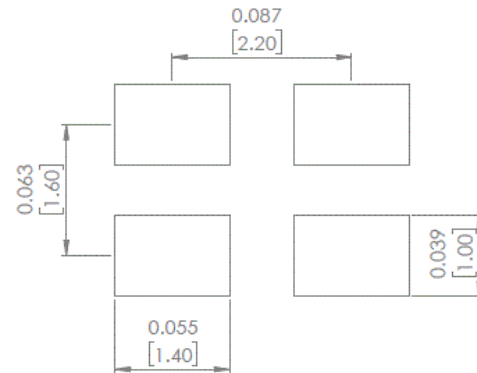

Pin #	Function
1	Tri-State
2	GND
3	Output
4	Vdd

Note: Recommended to use approximately 0.01µF bypass capacitor between PIN 2 and PIN 4

INH Function	
PAD #1	PAD #3 (Output)
Open	Active
"H" Level	Active
"L" Level	High Z (No Oscillation)

Dimensions: inches (mm)



5101 Hidden Creek Ln Spicewood TX 78669
Phone: 512-371-6159 | Fax: 512-351-8858
For terms and conditions of sales, please visit:
www.abracon.com

REVISED: 06-19-23

ABRACON IS
ISO9001-2015
CERTIFIED

CONTINUOUS VOLTAGE SMD CRYSTAL OSCILLATOR

ASETDV

Request Samples



Check Inventory



ESD Sensitive



3.2 x 2.5 x 1.2mm
RoHS/RoHS II Compliant
MSL Level = 1

Reflow Profile [JEDEC J-STD-020]

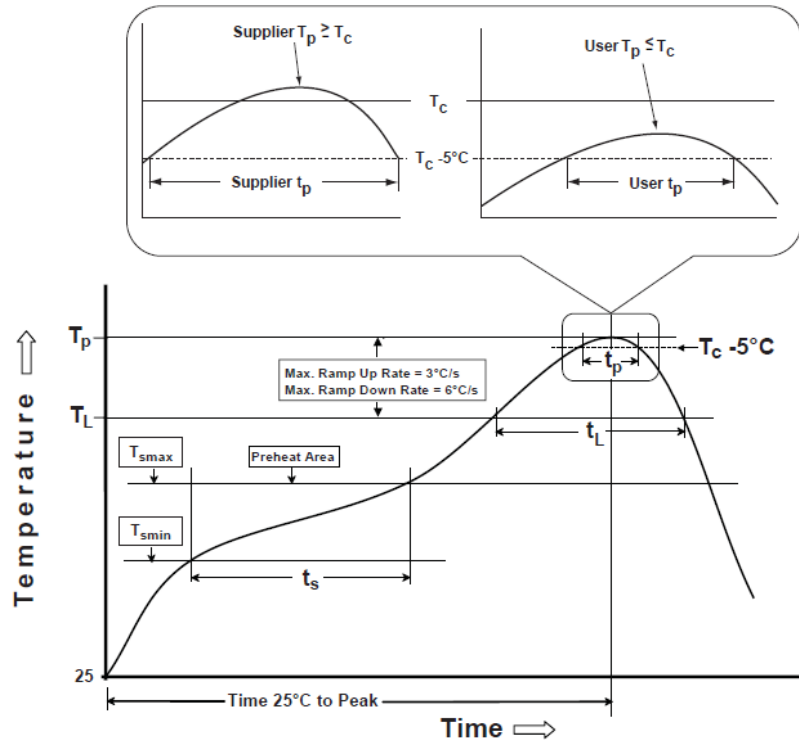

Table 1

SnPb Eutectic Process Classification Temperatures (T_c)

Package Thickness	Volume mm ³ <350	Volume mm ³ ≥350
<2.5 mm	235 °C	220 °C
≥2.5 mm	220 °C	220 °C

Table 2

Pb-Free Process Classification Temperatures (T_c)

Package Thickness	Volume mm ³ <350	Volume mm ³ 350-2000	Volume mm ³ >2000
<1.6 mm	260 °C	260 °C	260 °C
1.6 mm - 2.5 mm	260 °C	250 °C	245 °C
>2.5 mm	250 °C	245 °C	245 °C

Profile Feature	Sn-Pb Eutectic Assembly	Pb-Free Assembly
Preheat / soak		
Temperature minimum (T_{smin})	100°C	150°C
Temperature maximum (T_{smax})	150°C	200°C
Time (T_{smin} to T_{smax}) (t_s)	60 - 120 sec.	60 - 120 sec.
Average ramp-up rate (T_{smax} to T_p)	3°C/sec. max	3°C/sec. max
Liquidous temperature (T_L)	183°C	217°C
Time at liquidous (t_L)	60 - 150 sec.	60 - 150 sec.
Peak package body temperature (T_p)*	see Table 1	see Table 2
Time (t_p)** within 5°C of the specified classification temperature (T_c)	20 sec.	30 sec.
Ramp-down rate (T_p to T_{smax})	6°C/sec. max	6°C/sec. max
Time 25°C to peak temperature	6 min. max	8 min. max
Reflow cycles	2 max	2 max

*Tolerance for peak profile temperature (T_p) is defined as a supplier minimum and a user maximum.

**Tolerance for time at peak profile temperature (t_p) is defined as supplier minimum and a user maximum.



5101 Hidden Creek Ln Spicewood TX 78669
Phone: 512-371-6159 | Fax: 512-351-8858
For terms and conditions of sales, please visit:
www.abracon.com

REVISED: 06-19-23

ABRACON IS
ISO9001-2015
CERTIFIED

CONTINUOUS VOLTAGE SMD CRYSTAL OSCILLATOR

ASETDV

Request Samples



Check Inventory



3.2 x 2.5 x 1.2mm
RoHS/RoHS II Compliant
MSL Level = 1



ESD Sensitive



Packaging

T: 1,000pcs/reel

T3: 3,000pcs/reel

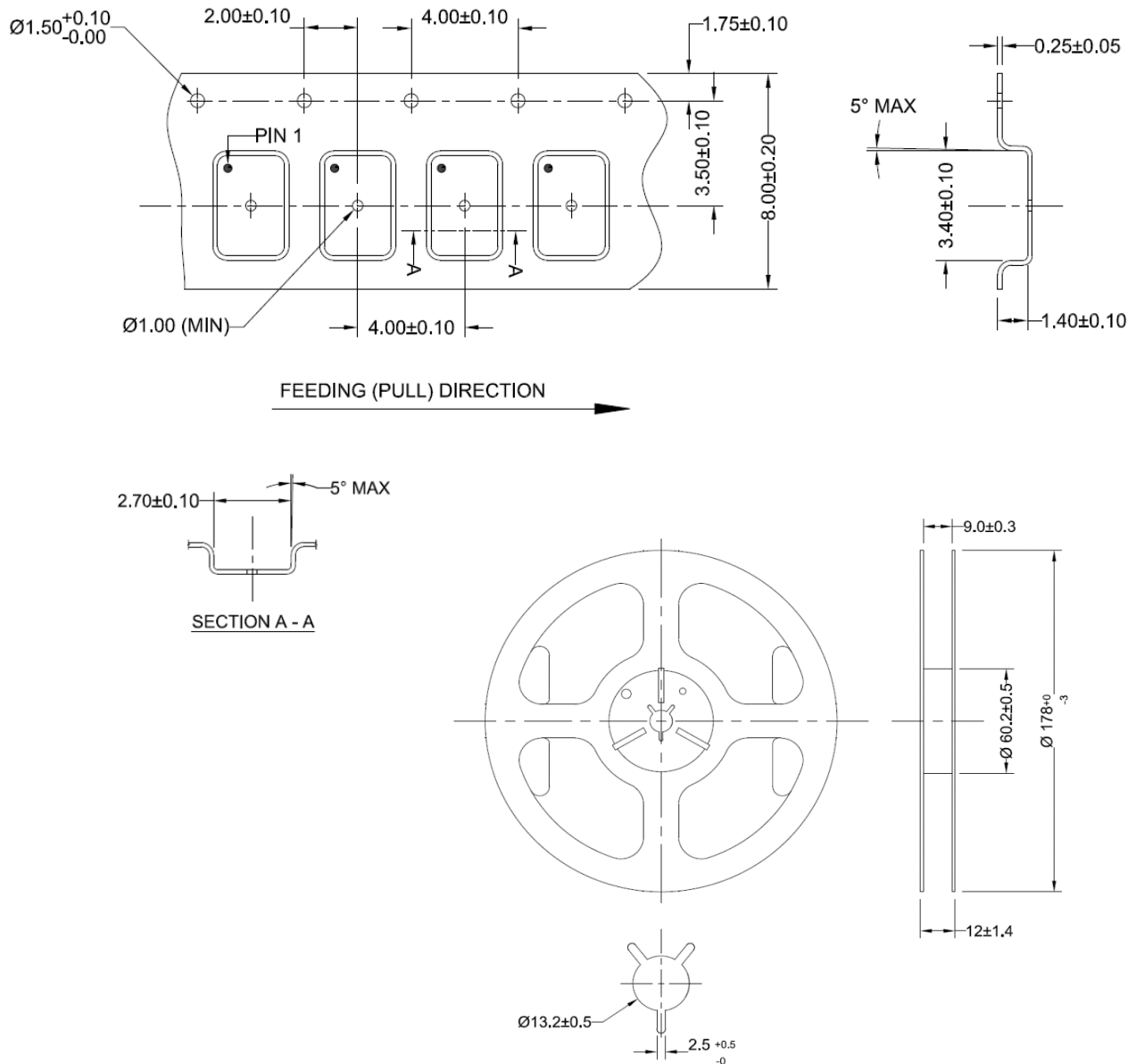

Dimensions: mm

ATTENTION: Abracon LLC's products are COTS – Commercial-Off-The-Shelf products; suitable for Commercial, Industrial and, where designated, Automotive Applications. Abracon's products are not specifically designed for Military, Aviation, Aerospace, Life-dependent Medical applications or any application requiring high reliability where component failure could result in loss of life and/or property. For applications requiring high reliability and/or presenting an extreme operating environment, written consent, and authorization from Abracon LLC is required. Please contact Abracon LLC for more information.



5101 Hidden Creek Ln Spicewood TX 78669
 Phone: 512-371-6159 | Fax: 512-351-8858
 For terms and conditions of sales, please visit:
www.abracon.com

REVISED: 06-19-23

ABRACON IS
 ISO9001-2015
 CERTIFIED