

COMBI 1610/3 LG

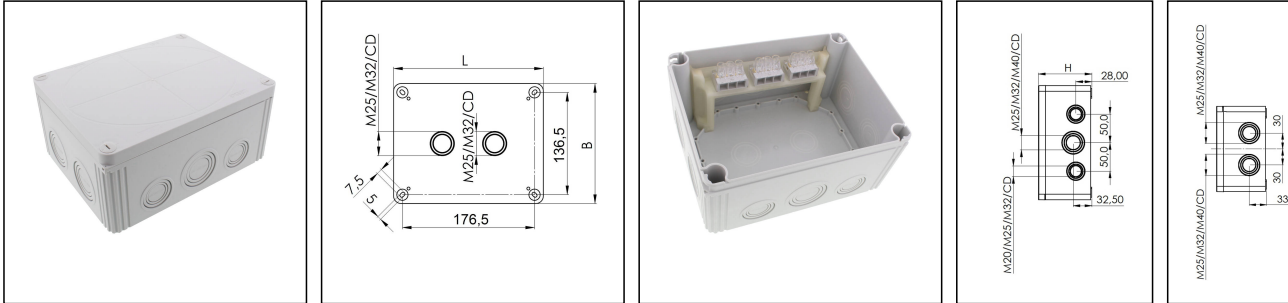

Products may differ in size, colour and appearance to those shown. If you require further information or customisation, please contact us directly.



Material	Polycarbonate
Material sealing gasket	PU
Temp. range min	-30 °C
Temp. range max	100 °C
Temperatures during install.	-5 °C - 60 °C
Protection class	IP66 / IP67
Glow wire test	960 °C
Voltage	690 V
Rated cross section	16 mm ²
Terminals/poles	3-pole, 16,0 mm ²
External dimensions LxWxH	200 x 160 x 94 mm
Product Color	RAL 7035
Order no. RAL 7035	10110736
Type	COMBI 1610/3 LG
Packing unit	1
EAN number	4007686251708
Tariff number	85369010
ETIM-Classification	EC002600

Remarks:

IP66: using the QUIXX self sealing membrane screw
 IP67: using the knockout entry together with ESKV cable gland

Equipment:
 - 10 knockouts side 6x M25/M32/M40; 4x M20/M25/M32
 - 2 knockouts in the bottom 2x M25/M32

Your Contact:
WISKA UK Ltd.
 Unit 7, Hurling Way · St. Columb Major Business Park · TR9 6SX, St. Columb Major, Cornwall · Great Britain
 ☎ +44-12-08816062 · 📠 +44-12-08816708
 info@wiska.co.uk · www.wiska.co.uk

- 4 captive cover screws
- including 3 QUIXX membrane spout EMT 32
- CD (cable diameter) 6-28mm
- inclusive terminal block 3-poles, 16mm²

Mounting:

4 internal openings outside of the sealing area

Recommended accessories

External mounting - COMBI LG

10108836

Spare parts

SP-HKT 1610 Terminal block

22001224

23.07.2023

Your Contact:

WISKA UK Ltd.

Unit 7, Hurling Way · St. Columb Major Business Park · TR9 6SX, St. Columb Major, Cornwall · Great Britain

☎ +44-12-08816062 · 📠 +44-12-08816708

info@wiska.co.uk · www.wiska.co.uk

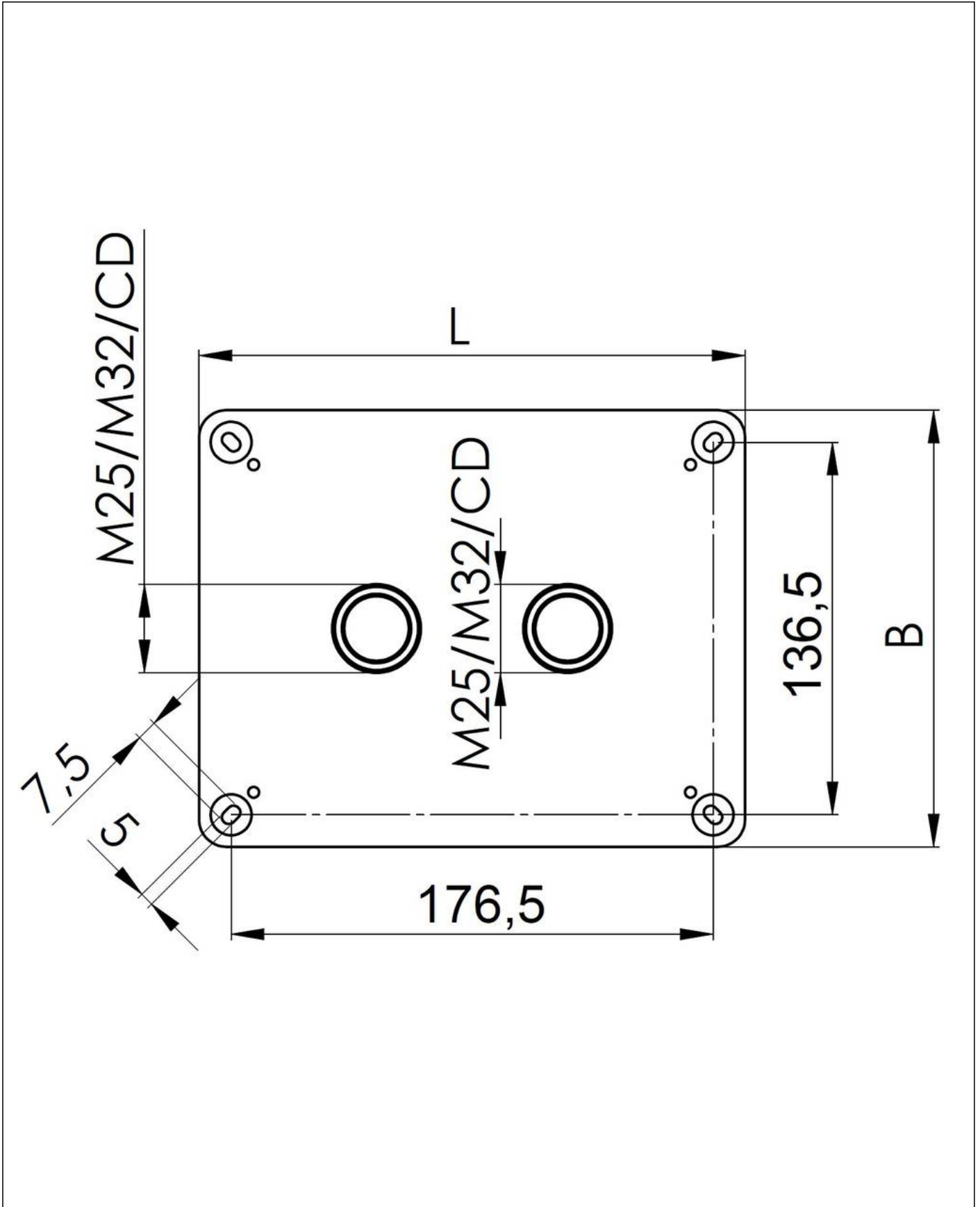

Your Contact:

WISKA UK Ltd.

Unit 7, Hurling Way · St. Columb Major Business Park · TR9 6SX, St. Columb Major, Cornwall · Great Britain

☎ +44-12-08816062 · 📠 +44-12-08816708

info@wiska.co.uk · www.wiska.co.uk

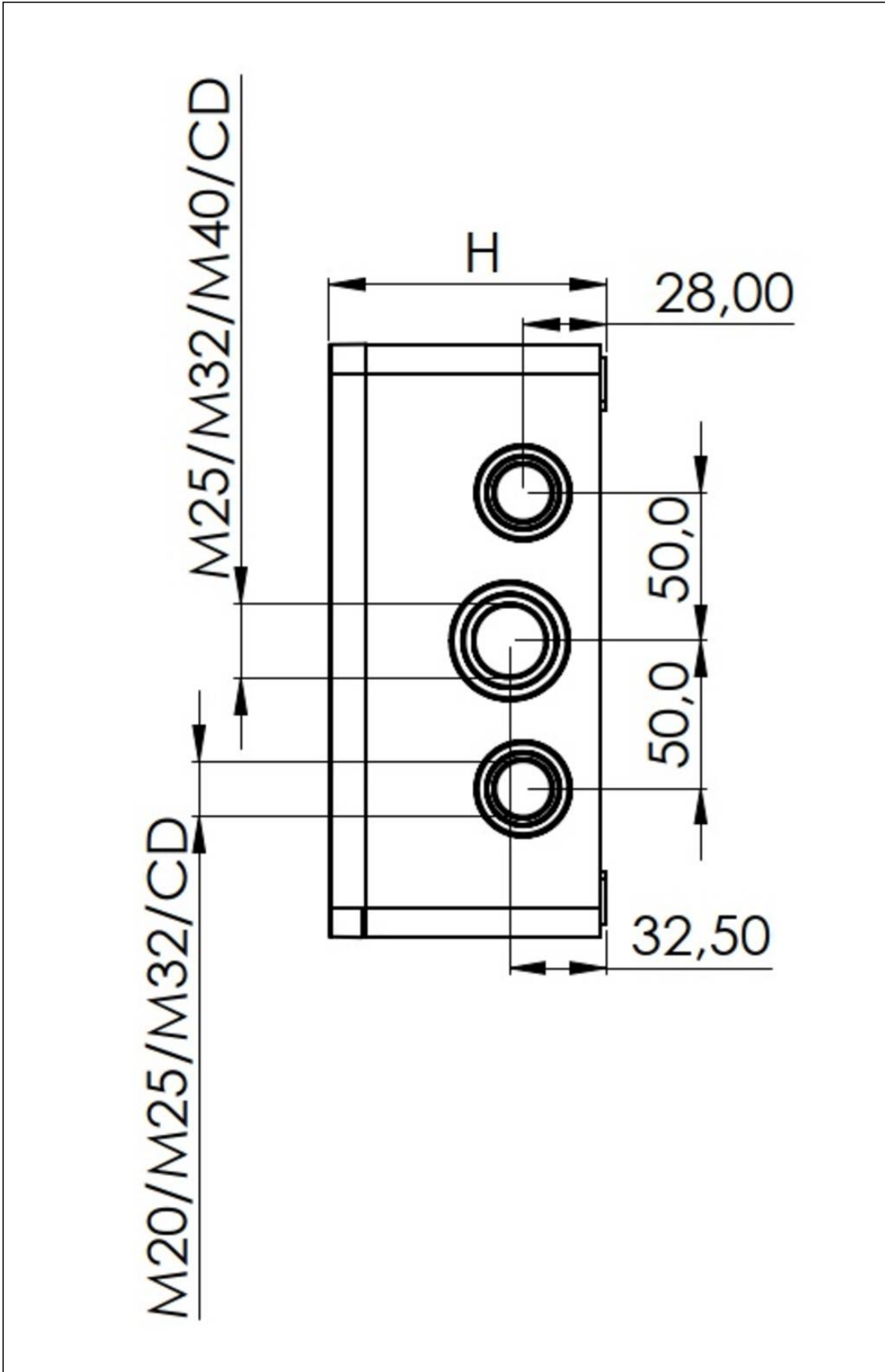

Your Contact:

WISKA UK Ltd.

Unit 7, Hurling Way · St. Columb Major Business Park · TR9 6SX, St. Columb Major, Cornwall · Great Britain

☎ +44-12-08816062 · 📠 +44-12-08816708

info@wiska.co.uk · www.wiska.co.uk