



OCX24688-FNM

Wi-Fi 6E Tri-Band Omni Array Antenna 2.4-2.484 GHz, 4.9 - 7.125 GHz

The OCX24688-FNM is a 2.4-2.484 / 4.9-7.125 GHz tri-band omnidirectional array antenna especially designed to complement interior or exterior mounted Wi-Fi 6E wireless network systems.

The integrated male N-connector is embedded in the antenna base cap for direct AP mounting. Sealing permits either upright or inverted orientation in outdoor locations. The antenna may also be pole-mounted when separation from the AP is required for optimal positioning.

FEATURES AND BENEFITS

- Tri-Band Wi-Fi coverage including legacy Wi-Fi, Wi-Fi 6, Wi-Fi 6E and Wi-Fi 7
- IP67 outdoor rated
- Direct mounting to access points or pole/mast mountable
- Suitable for upright or inverted orientation in both indoor and outdoor locations

APPLICATIONS

- WLAN
- Wi-Fi - Wi-Fi 7 (802.11be), Wi-Fi 6E (802.11ax), Wi-Fi 6 (802.11ax), Wi-Fi 5 (802.11ac), Wi-Fi 4 (802.11n), 802.11b/g
- Automation and control
- Outdoor and indoor rated

ELECTRICAL SPECIFICATION

Operating Frequency (MHz)	2400-2484	4900-4990	5170-5330	5490-7125
VSWR - Average	<2.5:1	<2.2:1	<2.0:1	<2.0:1
Peak Gain - Max (dBi)	5.0	5.5	6.7	7
Average Gain, Near Horizon (dBi)	3.5 ± 0.5	5.0 ± 1.0	5.0 ± 1.0	5.5 ± 1.0
Average 3 dB Beamwidth (°)	37	23	22	20
Input Max Power (W)	2			
Polarization	Linear, Vertical			
Azimuth Beamwidth (All Models)	360°, Omnidirectional			
Nominal Impedance (Ohms)	50			

MECHANICAL SPECIFICATION

Dimensions - height x circumference - mm (in.)	287 x 32Ø (11.3 x 1.26)
Weight - g (lbs.)	137 (0.3)
Radome	Polycarbonate, UV (White)
Cap and Base	ASA, UV

ENVIRONMENTAL SPECIFICATION

Operating Temperature - °C (°F)	-40 to +70°C (-40 to +158°F)
Storage Temperature - °C (°F)	-40 to +85°C (-40 to +185°F)
Ingress Protection (IP Rating)	IP67
Material Substance Compliance	RoHS Compliant CE & UKCA
Wind Loading (mph)	165

MECHANICAL DRAWINGS

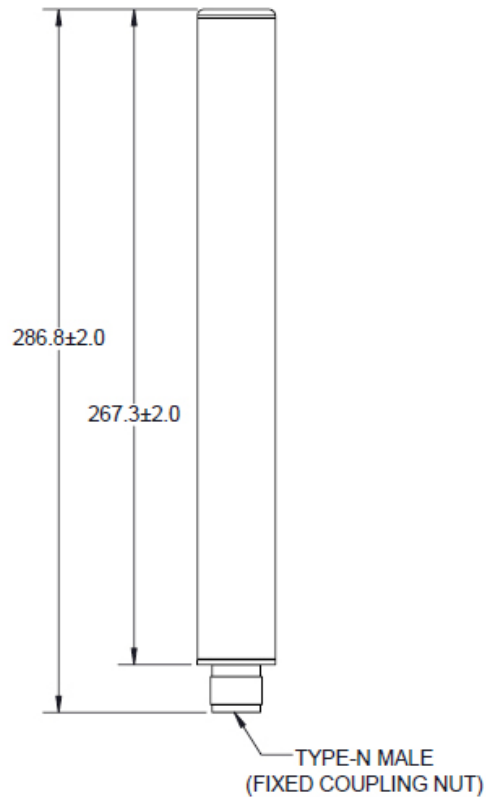
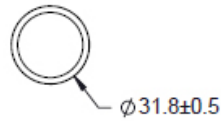

RADIATION PATTERNS

Radiation Patterns at 2.4 - 2.484 GHz

Azimuth Plane

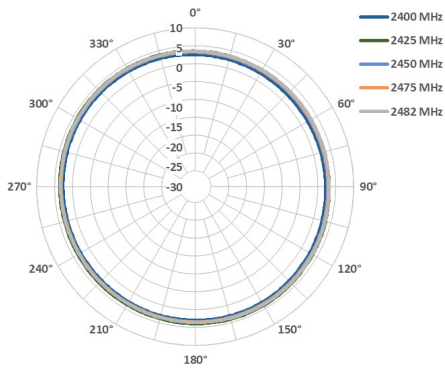

Phi 0° Plane

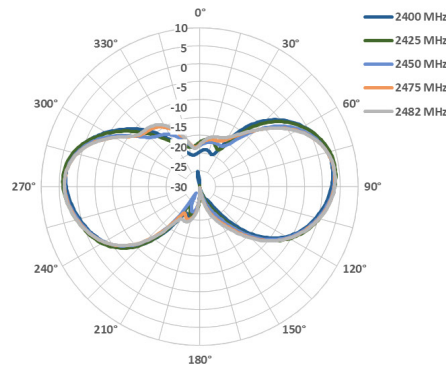

Phi 90° Plane

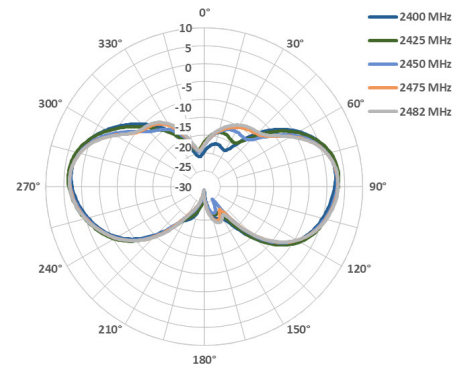

Radiation Patterns at 4.9 - 4.99 GHz

Azimuth Plane

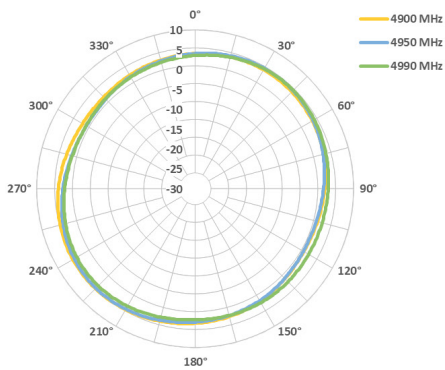

Phi 0° Plane

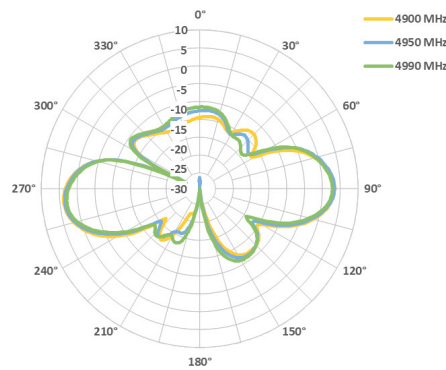

Phi 90° Plane

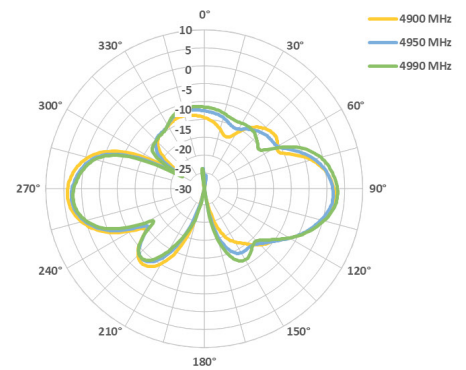

Radiation Patterns at 5.17 - 5.33 GHz

Azimuth Plane

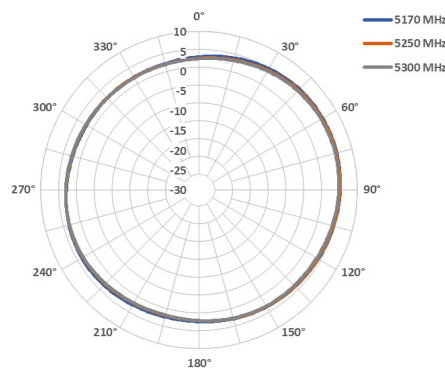

Phi 0° Plane

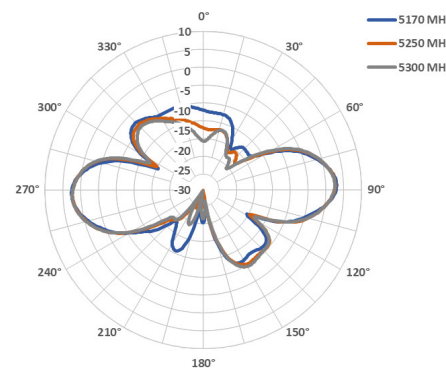

Phi 90° Plane

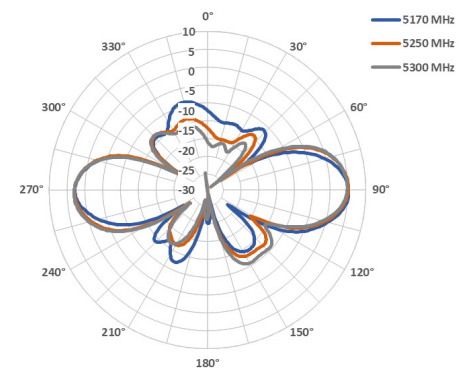

Radiation Patterns at 5.49 - 5.9 GHz

Azimuth Plane

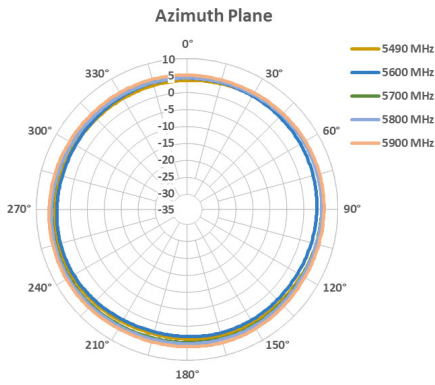

Phi 0° Plane

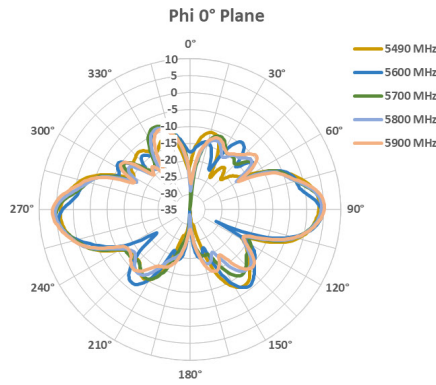

Phi 90° Plane

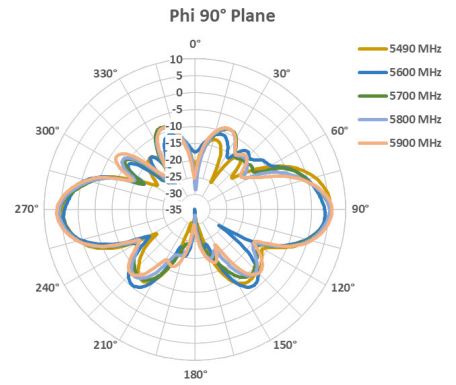

Radiation Patterns at 6.0 - 6.4 GHz

Azimuth Plane

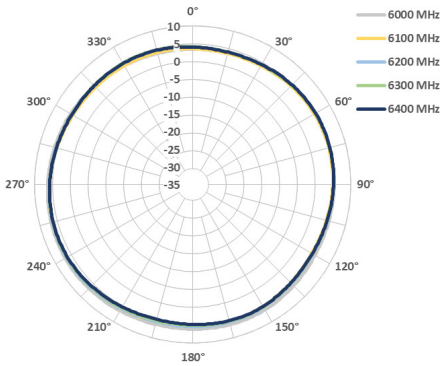

Phi 0° Plane

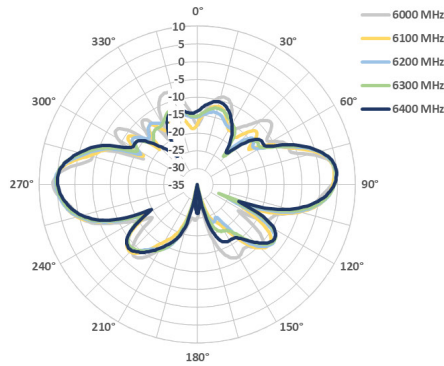

Phi 90° Plane

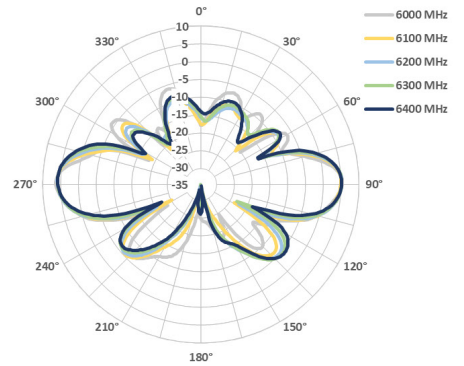

Radiation Patterns at 6.5 - 7.125 GHz

Azimuth Plane

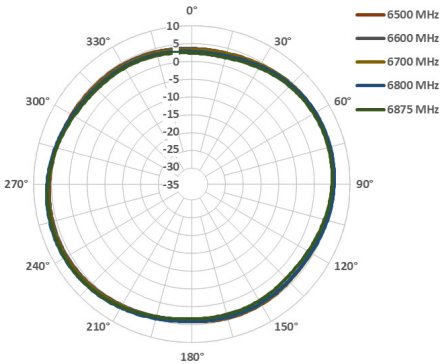

Phi 0° Plane

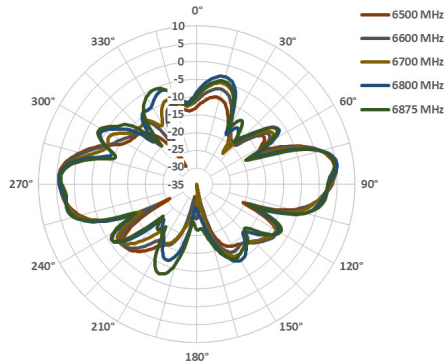

Phi 90° Plane

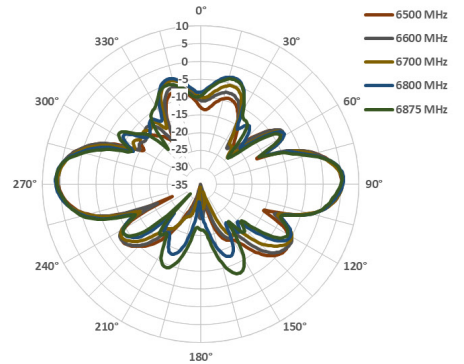

Radiation Patterns at 7.0 - 7.125 GHz

Azimuth Plane

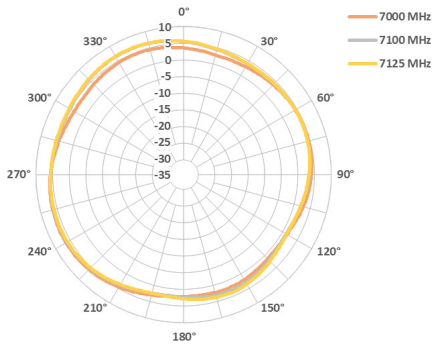

Phi 0° Plane

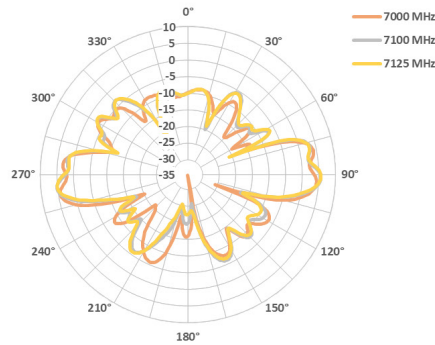

Phi 90° Plane

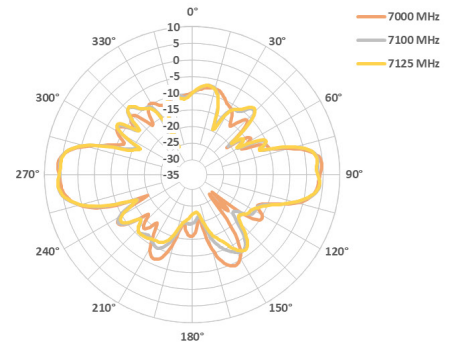

PACKING INFORMATION

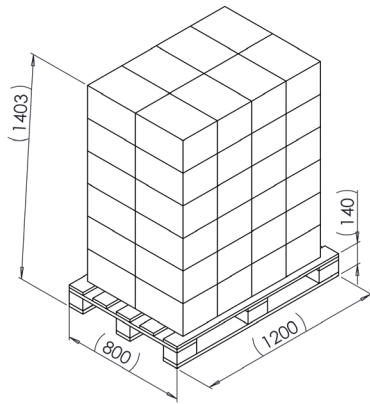

AIR PALLET

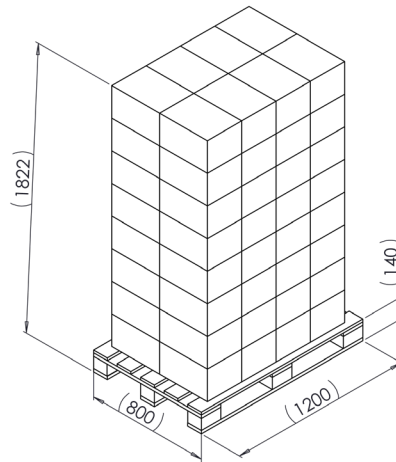

OCEAN PALLET

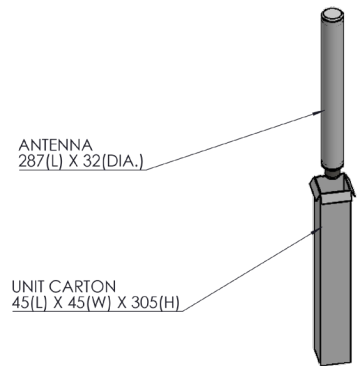

MASTER CARTON
355(L) X 255(W) X 210(H)
QTY:16pcs

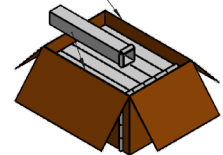

PACKAGED DIMENSIONS	Unit Carton	MASTER CARTON	AIR PALLET	OCEAN PALLET
Number of Antennas	1	16	768	960
Height mm(in)	305 (12)	210 (8.27)	1466 (57.24)	1791 (69.96)
Length mm(in)	45 (1.77)	355 (13.98)	1200 (47.24)	1200 (47.24)
Width mm(in)	45 (1.77)	255 (10.04)	800 (31.50)	800 (31.50)
Est. Shipping Weight kg (lbs.)	0.125 (0.28)	2.5 (5.51)	108 (238.10)	132 (291.01)

TE TECHNICAL SUPPORT CENTER

USA:	+1 (800) 522-6752
Canada:	+1 (905) 475-6222
Mexico:	+52 (0) 55-1106-0800
Latin/S. America:	+54 (0) 11-4733-2200
Germany:	+49 (0) 6251-133-1999
UK:	+44 (0) 800-267666
France:	+33 (0) 1-3420-8686
Netherlands:	+31 (0) 73-6246-999
China:	+86 (0) 400-820-6015

te.com

TE, and TE connectivity (logo) are trademarks owned or licensed by the TE Connectivity Ltd. family of companies. All other logos, products and/or company names referred to herein might be trademarks of their respective owners.

The information given herein, including drawings, illustrations and schematics which are intended for illustration purposes only, is believed to be reliable. However, TE Connectivity makes no warranties as to its accuracy or completeness and disclaims any liability in connection with its use. TE Connectivity's obligations shall only be as set forth in TE Connectivity's Standard Terms and Conditions of Sale for this product and in no case will TE Connectivity be liable for any incidental, indirect or consequential damages arising out of the sale, resale, use or misuse of the product. Users of TE Connectivity products should make their own evaluation to determine the suitability of each such product for the specific application.

TE Connectivity warrants to the original end user customer of its products that its products are free from defects in material and workmanship. Subject to conditions and limitations TE Connectivity will, at its option, either repair or replace any part of its products that prove defective because of improper workmanship or materials. This limited warranty is in force for the useful lifetime of the original end product into which the TE Connectivity product is installed. Useful lifetime of the original end product may vary but is not to exceed one (1) year from the original date of the end product purchase.

©2023 TE Connectivity. All Rights Reserved.

05/23 Original