

Data Sheet | Item Number: 2022-1401

2-conductor/2-pin carrier terminal block; 2.5 mm²; for DIN-rail 35 x 15 and 35 x 7.5;
Push-in CAGE CLAMP®; 2,50 mm²; gray

<https://www.wago.com/2022-1401>

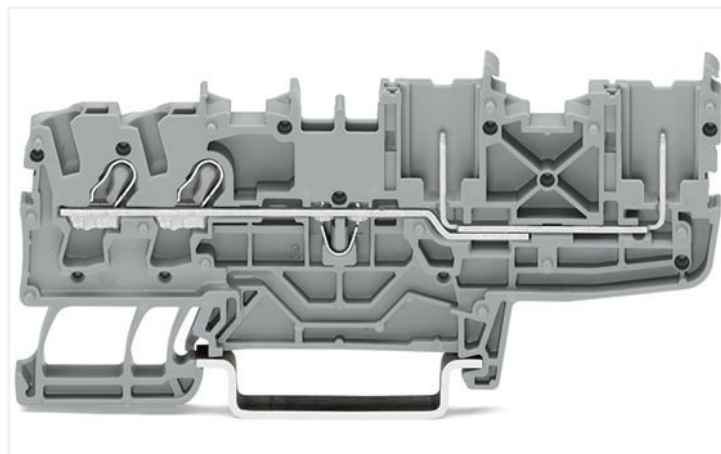
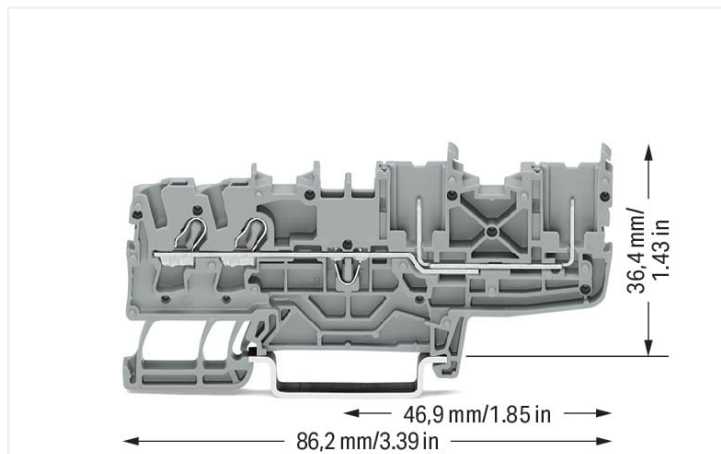

Color: ■ gray

Electrical data

Ratings per	IEC/EN 60947-7-1		
Overvoltage category	III	III	II
Pollution degree	3	2	2
Nominal voltage	690 V	-	-
Rated surge voltage	6 kV	-	-
Rated current	24 A	-	-
Current at conductor cross-section (max.) mm ²	28 A	-	-

Approvals per	UL 1059		
Use group	B	C	D
Rated voltage	600 V	600 V	-
Rated current	20 A	20 A	-

Approvals per	CSA 22.2 No 158		
Use group	B	C	D
Rated voltage	-	600 V	-
Rated current	-	20 A	-

Power Loss	
Power loss, per pole (potential)	0.7661 W
Rated current I _N for specified power loss	24 A
Resistance value for specified, current-dependent power loss	0.00133 Ω

Connection data

Connection points	2
Female plug slots	2
Total number of potentials	1
Number of levels	1

Connection 1	
Connection technology	Push-in CAGE CLAMP®
Actuation type	Operating tool
Connectable conductor materials	Copper
Nominal cross-section	2.5 mm ²
Solid conductor	0.25 ... 4 mm ² / 22 ... 12 AWG
Solid conductor; push-in termination	1 ... 4 mm ² / 18 ... 12 AWG
Fine-stranded conductor	0.25 ... 4 mm ² / 22 ... 12 AWG
Fine-stranded conductor; with insulated ferrule	0.25 ... 2.5 mm ² / 22 ... 14 AWG
Fine-stranded conductor; with ferrule; push-in termination	1 ... 2.5 mm ² / 18 ... 14 AWG
Note (conductor cross-section)	Depending on the conductor characteristic, a conductor with a smaller cross-section can also be inserted via push-in termination.
Strip length	10 ... 12 mm / 0.39 ... 0.47 inches
Wiring direction	Front-entry wiring

Physical data

Width	5.2 mm / 0.205 inches
Height	86.2 mm / 3.394 inches
Depth from upper-edge of DIN-rail	36.4 mm / 1.433 inches

Mechanical data

Mounting type	DIN-35 rail
Marking level	Center/side marking

Material data

Note (material data)	Information on material specifications can be found here
Color	gray
Material group	I
Insulation material	Polyamide (PA66)
Flammability class per UL94	V0
Fire load	0.181 MJ
Weight	9.3 g

Environmental requirements

Processing temperature	-35 ... +85 °C
Continuous operating temperature	-60 ... +105 °C

Commercial data

Product Group	18 (X-COM-System)
eCl@ss 10.0	27-14-11-20
eCl@ss 9.0	27-14-11-20
ETIM 8.0	EC000897
ETIM 7.0	EC000897
PU (SPU)	50 pcs
Packaging type	Box
Country of origin	CN
GTIN	4050821145226
Customs tariff number	85366990990

Environmental Product Compliance

RoHS Compliance Status	Compliant, No Exemption
------------------------	-------------------------

Approvals / Certificates

General approvals



General approvals

UL Underwriters Laboratories Inc.	UL 1059	E45172
---	---------	--------

Approval	Standard	Certificate Name
CCA DEKRA Certification B.V.	EN 60947	NTR CCA NL-7864
CSA DEKRA Certification B.V.	C22.2 No. 158	2437422
KEMA/KEUR DEKRA Certification B.V.	EN 60947	71-116567

Declarations of conformity and manufacturer's declarations

Approval	Standard	Certificate Name
EU-Declaration of Conformity WAGO GmbH & Co. KG	-	-
UK-Declaration of Conformity WAGO GmbH & Co. KG	-	-

Approvals for marine applications



Approval	Standard	Certificate Name
ABS American Bureau of Shipping	EN 60947	20-HG1941090-PDA
BV Bureau Veritas S.A.	EN 60947	38586/B0 BV
DNV GL Det Norske Veritas, Germanischer Lloyd	-	TAE00001V2
LR Lloyds Register	EN 60947	91/20112 (E9)

Downloads

Environmental Product Compliance

Compliance Search
Environmental Product Compliance 2022-1401 ↓

Documentation

Additional Information
Technical Section pdf 2142.18 KB ↓

Bid Text				
2022-1401	17.05.2019	xml	4.24 KB	↓
2022-1401	14.05.2019	docx	15.36 KB	↓

CAD/CAE-Data

CAD data
2D/3D Models 2022-1401 ↓

CAE data
EPLAN Data Portal 2022-1401 ↓
WSCAD Universe 2022-1401 ↓
ZUKEN Portal 2022-1401 ↓

1 Compatible Products

1.1 System counterpart

1.1.1 Female connector/socket



Item No.: 2022-101
 1-conductor female connector; Push-in CAGE CLAMP®; 4 mm²; Pin spacing 5.2 mm; 1-pole; 4,00 mm²; gray

1.2 Required Accessories

1.2.1 End plate

1.2.1.1 End plate



Item No.: 2022-1491
 End and intermediate plate; 1 mm thick; gray



Item No.: 2022-1492
 End and intermediate plate; 1 mm thick; orange

1.3 Optional Accessories

1.3.1 Coding

1.3.1.1 Coding



Item No.: 2022-100
 Carrier with 6 coding pins; for coding of female plugs; orange

1.3.2 DIN-rail

1.3.2.1 Mounting accessories



Item No.: 210-196
 Aluminum carrier rail; 35 x 8.2 mm; 1.6 mm thick; 2 m long; unslotted; similar to EN 60715; silver-colored



Item No.: 210-198
 Copper carrier rail; 35 x 15 mm; 2.3 mm thick; 2 m long; unslotted; according to EN 60715; copper-colored



Item No.: 210-197
 Steel carrier rail; 35 x 15 mm; 1.5 mm thick; 2 m long; slotted; similar to EN 60715; silver-colored



Item No.: 210-114
 Steel carrier rail; 35 x 15 mm; 1.5 mm thick; 2 m long; unslotted; similar to EN 60715; silver-colored



Item No.: 210-118
 Steel carrier rail; 35 x 15 mm; 2.3 mm thick; 2 m long; unslotted; according to EN 60715; silver-colored



Item No.: 210-115
 Steel carrier rail; 35 x 7.5 mm; 1 mm thick; 2 m long; slotted; according to EN 60715; "Hole width 18 mm; silver-colored



Item No.: 210-112
 Steel carrier rail; 35 x 7.5 mm; 1 mm thick; 2 m long; slotted; according to EN 60715; "Hole width 25 mm; silver-colored



Item No.: 210-113
 Steel carrier rail; 35 x 7.5 mm; 1 mm thick; 2 m long; unslotted; according to EN 60715; silver-colored

1.3.3 Ferrule

1.3.3.1 Ferrule

<p>Item No.: 216-241 Ferrule; Sleeve for 0.5 mm² / 20 AWG; insulated; electro-tin plated; electrolytic copper; gastight crimped; acc. to DIN 46228, Part 4/09.90; white</p>	<p>Item No.: 216-242 Ferrule; Sleeve for 0.75 mm² / 18 AWG; insulated; electro-tin plated; electrolytic copper; gastight crimped; acc. to DIN 46228, Part 4/09.90; gray</p>	<p>Item No.: 216-262 Ferrule; Sleeve for 0.75 mm² / 18 AWG; insulated; electro-tin plated; electrolytic copper; gastight crimped; acc. to DIN 46228, Part 4/09.90; gray</p>	<p>Item No.: 216-243 Ferrule; Sleeve for 1 mm² / AWG 18; insulated; electro-tin plated; electrolytic copper; gastight crimped; acc. to DIN 46228, Part 4/09.90; red</p>
<p>Item No.: 216-263 Ferrule; Sleeve for 1 mm² / AWG 18; insulated; electro-tin plated; electrolytic copper; gastight crimped; acc. to DIN 46228, Part 4/09.90; red</p>	<p>Item No.: 216-244 Ferrule; Sleeve for 1.5 mm² / AWG 16; insulated; electro-tin plated; electrolytic copper; gastight crimped; acc. to DIN 46228, Part 4/09.90; black</p>	<p>Item No.: 216-264 Ferrule; Sleeve for 1.5 mm² / AWG 16; insulated; electro-tin plated; electrolytic copper; gastight crimped; acc. to DIN 46228, Part 4/09.90; black</p>	<p>Item No.: 216-284 Ferrule; Sleeve for 1.5 mm² / AWG 16; insulated; electro-tin plated; electrolytic copper; gastight crimped; acc. to DIN 46228, Part 4/09.90; black</p>
<p>Item No.: 216-246 Ferrule; Sleeve for 2.5 mm² / AWG 14; insulated; electro-tin plated; electrolytic copper; gastight crimped; acc. to DIN 46228, Part 4/09.90; blue</p>	<p>Item No.: 216-266 Ferrule; Sleeve for 2.5 mm² / AWG 14; insulated; electro-tin plated; electrolytic copper; gastight crimped; acc. to DIN 46228, Part 4/09.90; blue</p>	<p>Item No.: 216-286 Ferrule; Sleeve for 2.5 mm² / AWG 14; insulated; electro-tin plated; electrolytic copper; gastight crimped; acc. to DIN 46228, Part 4/09.90; blue</p>	

1.3.4 Insulation stop

1.3.4.1 Insulation stop

<p>Item No.: 2002-171 Insulation stop; 0.25 - 0.5 mm²; 5 pieces/strip; light gray</p>	<p>Item No.: 2002-172 Insulation stop; 0.75 - 1 mm²; 5 pieces/strip; dark gray</p>

1.3.5 Jumper

1.3.5.1 Jumper

<p>Item No.: 2002-400 Continuous jumper; 2-way; insulated; light gray</p>	<p>Item No.: 2002-423/000-006 Continuous jumper; from 1 to 3; insulated; blue</p>	<p>Item No.: 2002-423 Continuous jumper; from 1 to 3; insulated; light gray</p>	<p>Item No.: 2002-423/000-005 Continuous jumper; from 1 to 3; insulated; red</p>
<p>Item No.: 2002-424/000-006 Continuous jumper; from 1 to 4; insulated; blue</p>	<p>Item No.: 2002-424 Continuous jumper; from 1 to 4; insulated; light gray</p>	<p>Item No.: 2002-424/000-005 Continuous jumper; from 1 to 4; insulated; red</p>	<p>Item No.: 2002-406/020-000 Delta jumper; insulated; light gray</p>
<p>Item No.: 2002-410/000-006 Jumper; 10-way; insulated; blue</p>	<p>Item No.: 2002-410 Jumper; 10-way; insulated; light gray</p>	<p>Item No.: 2002-410/000-005 Jumper; 10-way; insulated; red</p>	<p>Item No.: 2002-402/000-006 Jumper; 2-way; insulated; blue</p>
<p>Item No.: 2002-402 Jumper; 2-way; insulated; light gray</p>	<p>Item No.: 2002-402/000-005 Jumper; 2-way; insulated; red</p>	<p>Item No.: 2002-403/000-006 Jumper; 3-way; insulated; blue</p>	<p>Item No.: 2002-403 Jumper; 3-way; insulated; light gray</p>
<p>Item No.: 2002-403/000-005 Jumper; 3-way; insulated; red</p>	<p>Item No.: 2002-404/000-006 Jumper; 4-way; insulated; blue</p>	<p>Item No.: 2002-404 Jumper; 4-way; insulated; light gray</p>	<p>Item No.: 2002-404/000-005 Jumper; 4-way; insulated; red</p>
<p>Item No.: 2002-405/000-006 Jumper; 5-way; insulated; blue</p>	<p>Item No.: 2002-405 Jumper; 5-way; insulated; light gray</p>	<p>Item No.: 2002-405/000-005 Jumper; 5-way; insulated; red</p>	<p>Item No.: 2002-406/000-006 Jumper; 6-way; insulated; blue</p>

1.3.5.1 Jumper

Item No.: 2002-406 Jumper; 6-way; insulated; light gray	Item No.: 2002-406/000-005 Jumper; 6-way; insulated; red	Item No.: 2002-407/000-006 Jumper; 7-way; insulated; blue	Item No.: 2002-407 Jumper; 7-way; insulated; light gray
Item No.: 2002-407/000-005 Jumper; 7-way; insulated; red	Item No.: 2002-408/000-006 Jumper; 8-way; insulated; blue	Item No.: 2002-408 Jumper; 8-way; insulated; light gray	Item No.: 2002-408/000-005 Jumper; 8-way; insulated; red
Item No.: 2002-409/000-006 Jumper; 9-way; insulated; blue	Item No.: 2002-409 Jumper; 9-way; insulated; light gray	Item No.: 2002-409/000-005 Jumper; 9-way; insulated; red	Item No.: 2002-440 Jumper; from 1 to 10; insulated; light gray
Item No.: 2002-433 Jumper; from 1 to 3; insulated; light gray	Item No.: 2002-434 Jumper; from 1 to 4; insulated; light gray	Item No.: 2002-435 Jumper; from 1 to 5; insulated; light gray	Item No.: 2002-436 Jumper; from 1 to 6; insulated; light gray
Item No.: 2002-437 Jumper; from 1 to 7; insulated; light gray	Item No.: 2002-438 Jumper; from 1 to 8; insulated; light gray	Item No.: 2002-439 Jumper; from 1 to 9; insulated; light gray	Item No.: 2002-480 Staggered jumper; 10-way; insulated; light gray
Item No.: 2002-481 Staggered jumper; 11-way; insulated; light gray	Item No.: 2002-482 Staggered jumper; 12-way; insulated; light gray	Item No.: 2002-473/011-000 Staggered jumper; 2-way; from 1 to 3; insulated; light gray	Item No.: 2002-472 Staggered jumper; 2-way; insulated; light gray
Item No.: 2002-473 Staggered jumper; 3-way; insulated; light gray	Item No.: 2002-475/011-000 Staggered jumper; 3-way; insulated; light gray	Item No.: 2002-474 Staggered jumper; 4-way; insulated; light gray	Item No.: 2002-475 Staggered jumper; 5-way; insulated; light gray
Item No.: 2002-476 Staggered jumper; 6-way; insulated; light gray	Item No.: 2002-477 Staggered jumper; 7-way; insulated; light gray	Item No.: 2002-478 Staggered jumper; 8-way; insulated; light gray	Item No.: 2002-479 Staggered jumper; 9-way; insulated; light gray
Item No.: 2002-477/011-000 Staggered jumper; insulated; light gray	Item No.: 2002-479/011-000 Staggered jumper; insulated; light gray	Item No.: 2002-481/011-000 Staggered jumper; insulated; light gray	Item No.: 2002-405/011-000 Star point jumper; 3-way; insulated; light gray
Item No.: 210-103 Wire commoning chain; insulated; black	Item No.: 210-123 Wire commoning chain; insulated; blue		

1.3.6 Marking

1.3.6.1 Group marker carrier

Item No.: 2009-191 Group marker carrier; gray	Item No.: 2009-192 Group marker carrier; gray	Item No.: 2009-193 Group marker carrier; gray

1.3.6.2 Marker



Item No.: 2009-145
Mini-WSB Inline; for Smart Printer; 1700 pieces on roll; stretchable 5 - 5.2 mm; plain; snap-on type; white



Item No.: 248-501
Mini-WSB marking card; as card; not stretchable; plain; snap-on type; white



Item No.: 793-5501
WMB marking card; as card; for terminal block width 5 - 17.5 mm; stretchable 5 - 5.2 mm; plain; snap-on type; white



Item No.: 2009-115
WMB-Inline; for Smart Printer; 1500 pieces on roll; stretchable 5 - 5.2 mm; plain; snap-on type; white

1.3.6.3 Marker carrier



Item No.: 2002-161
Adaptor; gray



Item No.: 2009-198
Adaptor; gray

1.3.6.4 Marking strip



Item No.: 2009-110
Marking strips; for Smart Printer; on reel; not stretchable; plain; snap-on type; white

1.3.7 Protective warning marker

1.3.7.1 Cover



Item No.: 2002-115
Protective warning marker; for 5 terminal blocks; with high-voltage symbol, black; yellow

1.3.8 Push-in type wire jumper

1.3.8.1 Jumper



Item No.: 2009-414
Push-in type wire jumper; 1.5 mm²; insulated; 110 mm long; black



Item No.: 2009-414/000-005
Push-in type wire jumper; 1.5 mm²; insulated; 110 mm long; black



Item No.: 2009-416
Push-in type wire jumper; 1.5 mm²; insulated; 250 mm long; black



Item No.: 2009-414/000-006
Push-in type wire jumper; insulated; 110 mm long; black



Item No.: 2009-412
Push-in type wire jumper; insulated; 60 mm long; black

1.3.9 Test and measurement

1.3.9.1 Testing accessories



Item No.: 2002-560

Modular TOPJOB®S connector; modular; for jumper contact slot; 10-pole; 2,50 mm²; gray



Item No.: 2002-511

Modular TOPJOB®S connector; modular; for jumper contact slot; 1-pole; 2,50 mm²; gray



Item No.: 2002-552

Modular TOPJOB®S connector; modular; for jumper contact slot; 2-pole; 2,50 mm²; gray



Item No.: 2002-553

Modular TOPJOB®S connector; modular; for jumper contact slot; 3-pole; 2,50 mm²; gray



Item No.: 2002-554

Modular TOPJOB®S connector; modular; for jumper contact slot; 4-pole; 2,50 mm²; gray



Item No.: 2002-555

Modular TOPJOB®S connector; modular; for jumper contact slot; 5-pole; 2,50 mm²; gray



Item No.: 2002-556

Modular TOPJOB®S connector; modular; for jumper contact slot; 6-pole; 2,50 mm²; gray



Item No.: 2002-557

Modular TOPJOB®S connector; modular; for jumper contact slot; 7-pole; 2,50 mm²; gray



Item No.: 2002-558

Modular TOPJOB®S connector; modular; for jumper contact slot; 8-pole; 2,50 mm²; gray



Item No.: 2002-559

Modular TOPJOB®S connector; modular; for jumper contact slot; 9-pole; 2,50 mm²; gray



Item No.: 2002-549

Spacer module; modular; e.g., for bridging commoned terminal blocks; gray



Item No.: 2009-174

Test plug adapter; for 4 mm Ø test plugs; for testing TOPJOB®S rail-mounted terminal blocks; gray



Item No.: 2009-182

Testing tap; for max. 2.5 mm²; tool-free connection for individual test wires 0.08 - 2.5 mm; gray



Item No.: 859-500

WAGO Test pin; 1 mm Ø; 30 V AC / 60 V DC; CAT0; 1 A; 10 mm uninsulated; Test lead for soldering up to 0,5mm²

1.3.10 Tool

1.3.10.1 Operating tool



Item No.: 210-720

Operating tool; Blade: 3.5 x 0.5 mm; with a partially insulated shaft; multicoloured

Installation Notes

Installation

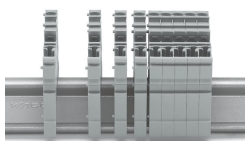

Snap individual carrier terminal blocks onto the DIN-rail and slide together.

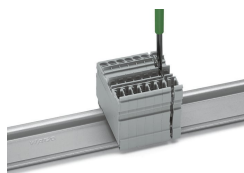

Open the assembly by laterally sliding a block via operating tool (3.5 x 0.5 mm blade).

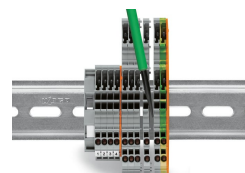

Separate terminal block assembly and slide individual terminal blocks laterally using an operating tool.

Conductor termination

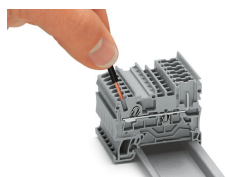

Push-in CAGE CLAMP® enables solid conductors to be connected by simply pushing them into the unit.

Commoning

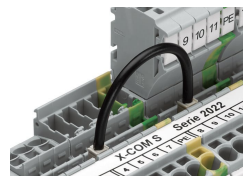
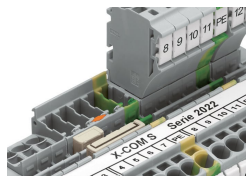
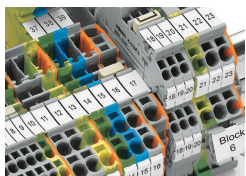

Commoning X-COM®S-SYSTEM Terminal Blocks using jumpers for TOPJOB® S Terminal Blocks. An end plate provides connection to TOPJOB® S Terminal Blocks. 2020 and 2022 Series Terminal Blocks are combinable. Jumper slots are on the same level for both series.

Pairing push-in comb style jumpers.

Commoning with push-in type wire jumper.

Testing

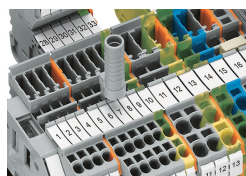

Test plug adapter (2009-174) for 4 mm test plugs or banana plugs – also suitable for X-COM®S-SYSTEM-MINI Terminal Blocks.

Coding

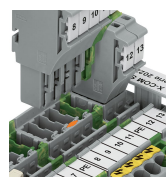
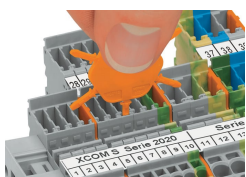

Insert coding pin into the corresponding slot and twist it off.

Coding a female plug: remove coding finger using a suitable tool.

Insert a coding pin (2022-100) into the corresponding location of the carrier terminal block.

Marking

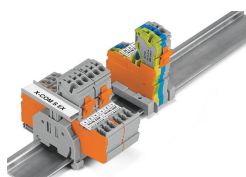
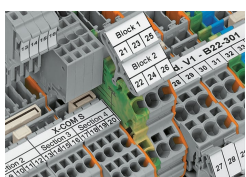

Clear marking via large marking area

Group marking with height-adjustable group marker carrier (2009-163)

Security

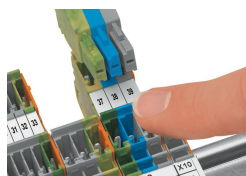

Carrier terminal blocks and female plugs are touch-proof.

Subject to changes. Please also observe the further product documentation!

Current addresses can be found at: www.wago.com