

## Data Sheet | Item Number: 769-103/021-000

1-conductor female connector; CAGE CLAMP®; 4 mm<sup>2</sup>; Pin spacing 5 mm; 3-pole;  
coding finger; Lateral locking levers; 4,00 mm<sup>2</sup>; gray

<https://www.wago.com/769-103/021-000>

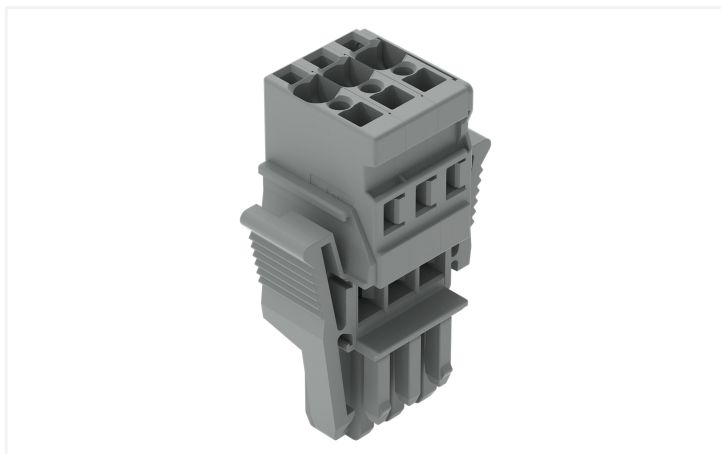

Color: ■ gray

### Notes

#### Safety information

According to EN 61984, pluggable connectors without current interrupting capacity must not be mated or unmated when live or under load.

### Electrical data

Ratings per	IEC/EN 61984		
	III	III	II
Overvoltage category	III	III	II
Pollution degree	3	2	2
Nominal voltage	500 V	-	-
Rated surge voltage	6 kV	-	-
Rated current	32 A	-	-

### Connection data

Connection points	3
Total number of potentials	3

#### Connection 1

Connection technology	CAGE CLAMP®
Actuation type	Operating tool
Connectable conductor materials	Copper
Nominal cross-section	4 mm <sup>2</sup> / 12 AWG
Solid conductor	0.08 ... 4 mm <sup>2</sup> / 28 ... 12 AWG
Fine-stranded conductor	0.08 ... 4 mm <sup>2</sup> / 28 ... 12 AWG
Strip length	8 ... 9 mm / 0.31 ... 0.35 inches
Pole number	3
Wiring direction	Front-entry wiring

### Physical data

Width	30 mm / 1.205 inches
Height	45.2 mm / 1.78 inches
Depth	18.3 mm / 0.72 inches
Module width	5 mm / 0.197 inches

### Mechanical data

Variable coding	Yes
Direct ground contact to DIN-rail/drilled hole/housing	No
Marking level	Side marking
Anti-rotation protection	Yes

### Plug-in connection

Contact type (pluggable connector)	Female connector/socket
Connector (connection type)	for conductor
Mismating protection	No
Plugging without loss of pin spacing	Yes
Locking lever	Yes

### Material data

Note (material data)	<a href="_blank">Information on material specifications can be found here</a>
Color	gray
Material group	I
Insulation material	Polyamide (PA66)
Flammability class per UL94	V0
Fire load	0.27 MJ
Halogen-free	Yes
Weight	8.3 g

### Environmental requirements

Processing temperature	-35 ... +85 °C
Continuous operating temperature	-60 ... +105 °C

### Commercial data

Product Group	18 (X-COM-System)
eCl@ss 10.0	27-14-11-06
eCl@ss 9.0	27-14-11-06
ETIM 8.0	EC001284
ETIM 7.0	EC001284
PU (SPU)	25 pcs
Packaging type	Box
Country of origin	DE
GTIN	4044918481007
Customs tariff number	85366990990

**Environmental Product Compliance**

RoHS Compliance Status	Compliant, No Exemption
------------------------	-------------------------

**Approvals / Certificates**

**General approvals** **Declarations of conformity and manufacturer's declarations**



Approval	Standard	Certificate Name
CCA DEKRA Certification B.V.	EN 60947	NTR NL-7626
CCA DEKRA Certification B.V.	EN 61984	2190419.02
CCA DEKRA Certification B.V.	IEC 61984	NL-47799/A1
CSA DEKRA Certification B.V.	C22.2 No. 158	1101144
KEMA/KEUR DEKRA Certification B.V.	EN 60947	2190419.01
UL Underwriters Laboratories Inc.	UL 1977	E 45171
UR Underwriters Laboratories Inc.	UL 1059	E45172

Approval	Standard	Certificate Name
EU-Declaration of Conformity WAGO GmbH & Co. KG	-	-
UK-Declaration of Conformity WAGO GmbH & Co. KG	-	-

**Approvals for marine applications**



Approval	Standard	Certificate Name
ABS American Bureau of Shipping	EN 60947	20-HG1941090-PDA
DNV GL Det Norske Veritas, Germanischer Lloyd	-	TAE00001V2

**Downloads**

**Environmental Product Compliance**

<b>Compliance Search</b>	
Environmental Product Compliance 769-103/021-000	<a href="#">↓</a>

**Documentation**

Additional Information		
Technical Section	pdf 2142.18 KB	<a href="#">↓</a>

Bid Text			
769-103/021-000	19.02.2019	xml 3.21 KB	<a href="#">↓</a>
769-103/021-000	04.10.2017	doc 25.00 KB	<a href="#">↓</a>

CAD/CAE-Data	
<b>CAD data</b>	<b>CAE data</b>
2D/3D Models 769-103/021-000 <a href="#">↓</a>	EPLAN Data Portal 769-103/021-000 <a href="#">↓</a>
	WSCAD Universe 769-103/021-000 <a href="#">↓</a>
	ZUKEN Portal 769-103/021-000 <a href="#">↓</a>

## 1 Compatible Products

### 1.1 Optional Accessories

#### 1.1.1 Cover

##### 1.1.1.1 Cover



**Item No.: 769-436**

Jumper cover; for 1-conductor female plugs; for 5 poles; gray

### 1.1.2 Ferrule

#### 1.1.2.1 Ferrule



**Item No.: 216-301**

Ferrule; Sleeve for 0.25 mm<sup>2</sup> / AWG 24; insulated; electro-tin plated; yellow



**Item No.: 216-302**

Ferrule; Sleeve for 0.34 mm<sup>2</sup> / 22 AWG; insulated; electro-tin plated; light turquoise



**Item No.: 216-201**

Ferrule; Sleeve for 0.5 mm<sup>2</sup> / 20 AWG; insulated; electro-tin plated; white



**Item No.: 216-101**

Ferrule; Sleeve for 0.5 mm<sup>2</sup> / AWG 22; un-insulated; electro-tin plated; silver-colored



**Item No.: 216-202**

Ferrule; Sleeve for 0.75 mm<sup>2</sup> / 18 AWG; insulated; electro-tin plated; gray



**Item No.: 216-102**

Ferrule; Sleeve for 0.75 mm<sup>2</sup> / AWG 20; un-insulated; electro-tin plated; silver-colored



**Item No.: 216-203**

Ferrule; Sleeve for 1 mm<sup>2</sup> / AWG 18; insulated; electro-tin plated; red



**Item No.: 216-103**

Ferrule; Sleeve for 1 mm<sup>2</sup> / AWG 18; un-insulated; electro-tin plated



**Item No.: 216-204**

Ferrule; Sleeve for 1.5 mm<sup>2</sup> / AWG 16; un-insulated; electro-tin plated; black



**Item No.: 216-104**

Ferrule; Sleeve for 1.5 mm<sup>2</sup> / AWG 16; un-insulated; electro-tin plated; silver-colored



**Item No.: 216-206**

Ferrule; Sleeve for 2.5 mm<sup>2</sup> / AWG 14; insulated; electro-tin plated; blue

### 1.1.3 Insulation stop

### 1.1.3.1 Insulation stop



**Item No.: 769-470**

Insulation stop; 0.08 - 0.2 mm<sup>2</sup> "s" (0.14 mm<sup>2</sup> "f-st"); 5 pieces/strip; white

**Item No.: 769-471**

Insulation stop; 0.25 - 0.5 mm<sup>2</sup>; 5 pieces/strip; light gray

**Item No.: 769-472**

Insulation stop; 0.75 - 1 mm<sup>2</sup>; 5 pieces/strip; dark gray

### 1.1.4 Jumper

#### 1.1.4.1 Jumper



**Item No.: 769-402**

Jumper; insulated; gray

### 1.1.5 Locking system

#### 1.1.5.1 Locking system



**Item No.: 769-430**

Locking lever; for female connectors; 1 part; Pin spacing 5 mm; 2-pole; gray

**Item No.: 769-431**

Locking lever; for female connectors; 1 part; Pin spacing 5 mm; 2-pole; orange

### 1.1.6 Marking

#### 1.1.6.1 Label



**Item No.: 210-805**

Labels; for Smart Printer; permanent adhesive; 6 x 15 mm; white

**Item No.: 210-805/000-002**

Labels; for Smart Printer; permanent adhesive; 6 x 15 mm; yellow

#### 1.1.6.2 Marker



**Item No.: 2009-145**

Mini-WSB Inline; for Smart Printer; 1700 pieces on roll; stretchable 5 - 5.2 mm; plain; snap-on type; white

**Item No.: 248-501**

Mini-WSB marking card; as card; not stretchable; plain; snap-on type; white

#### 1.1.6.3 Marking strip



**Item No.: 210-831**

Marking strips; on reel; 2.3 mm wide; plain; Self-adhesive; white

**Item No.: 210-832**

Marking strips; on reel; 3 mm wide; plain; Self-adhesive; white

**Item No.: 210-834**

Marking strips; on reel; 5 mm wide; plain; Self-adhesive; white

### 1.1.7 Protective warning marker

### 1.1.7.1 Cover



**Item No.: 280-415**

Protective warning marker; for 5 terminal blocks; with high-voltage symbol, black; yellow

### 1.1.8 Strain relief

#### 1.1.8.1 Strain relief



**Item No.: 769-1603**

Strain relief housing; for female and male connectors; 2 parts; Pin spacing 5 mm; 3-pole; gray



**Item No.: 769-411**

Strain relief plate; for female and male connectors; 1 part; Pin spacing 5 mm; 2- to 3-pole; gray

### 1.1.9 Test and measurement

#### 1.1.9.1 Testing accessories



**Item No.: 210-136**

Test plug; 2 mm Ø; with 500 mm cable; red

### 1.1.10 Tool

#### 1.1.10.1 Operating tool



**Item No.: 210-490**

Operating tool



**Item No.: 769-434**

Operating tool; made of insulating material; 1-way; loose; white

## Installation Notes

### Conductor termination

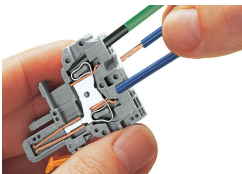

**CAGE CLAMP® connection**

Female plug: Inserting/removing a conductor via operating tool.

Operation 90° to conductor is also possible.

With ferruled conductors, it is necessary to use a terminal block one size smaller than the conductor's nominal cross-section.

### Commoning

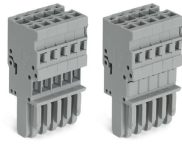
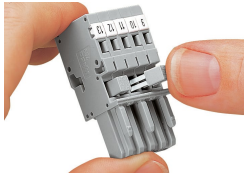

Commoning 1-conductor female plugs via miniature adjacent jumpers.

Jumper cover for 1-conductor female plugs

### Coding



Coding a female plug by removing coding finger(s) via cutting tool. Do not remove the first and last coding fingers or use an additional locking lever.

### Locking system

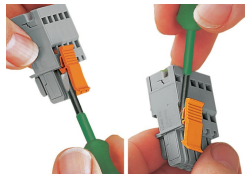

Locking/releasing a lever.

### Strain relief

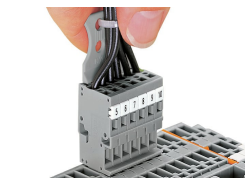

Removing a female plug via conductor bundle provided with strain relief plate.

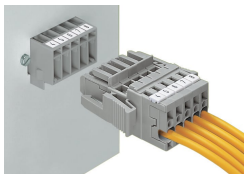

Male header with mounting flanges  
1-conductor female plug with lateral locking levers

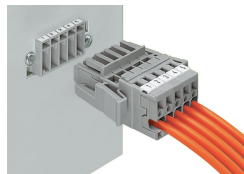

Male header and 1-conductor female plug with lateral locking levers

Marking



Labeling a female plug with CAGE CLAMP® connection via Mini-WSB Quick Markers.