

## Data Sheet | Item Number: 2001-1302

3-conductor through terminal block; 1.5 mm<sup>2</sup>; suitable for Ex e II applications; side and center marking; for DIN-rail 35 x 15 and 35 x 7.5; Push-in CAGE CLAMP®; 1,50 mm<sup>2</sup>; orange

<https://www.wago.com/2001-1302>

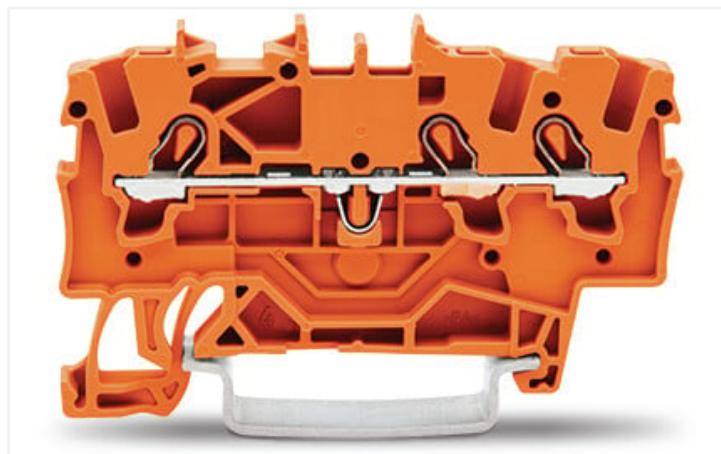
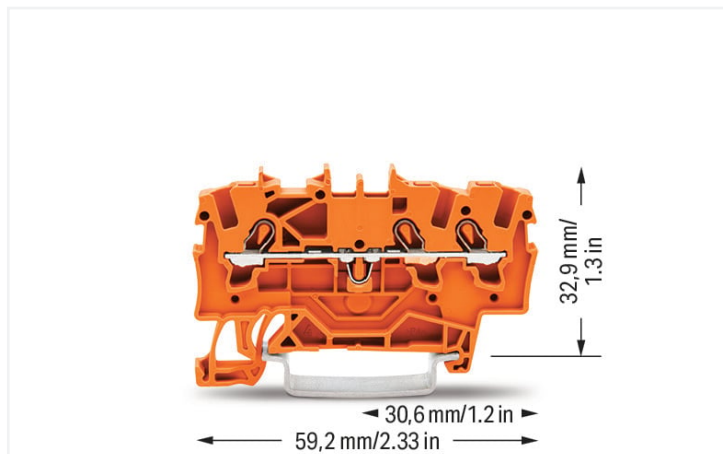

Color: ■ orange

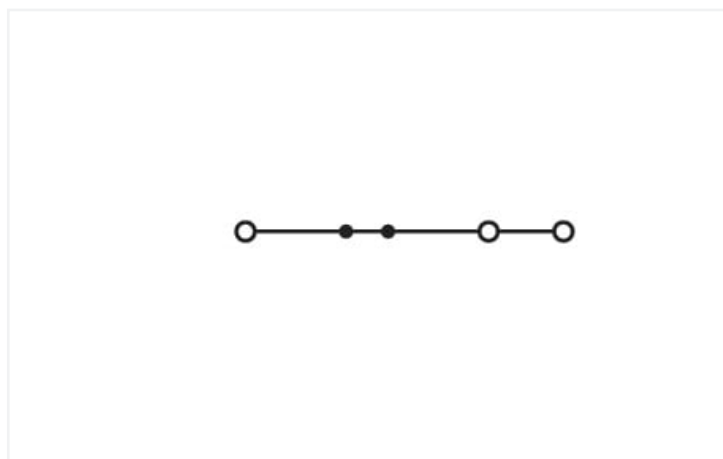

Similar to illustration

### Electrical data

Ratings per	IEC/EN 60947-7-1		
Overvoltage category	III	III	II
Pollution degree	3	2	2
Nominal voltage	800 V	-	-
Rated surge voltage	8 kV	-	-
Rated current	17.5 A	-	-
Current at conductor cross-section (max.) mm <sup>2</sup>	24 A	-	-

Approvals per	UL 1059		
Use group	B	C	D
Rated voltage	600 V	600 V	-
Rated current	15 A	15 A	-

Approvals per	CSA 22.2 No 158		
Use group	B	C	D
Rated voltage	600 V	600 V	-
Rated current	15 A	15 A	-

Ex information	
Reference hazardous areas	See application instructions in section "Knowledge and Downloads – Documentation – Additional Information: Technical Section; Technical Explanations"
Ratings per	ATEX: PTB 05 ATEX 1094 U / IECEx: PTB 05.0034U (Ex eb IIC Gb)
Rated voltage EN (Ex e II)	550 V
Rated current (Ex e II)	17 A
Rated current (Ex e II) with jumper	16 A

### Power Loss

Power loss, per pole (potential)	0.5929 W
Rated current $I_N$ for specified power loss	18 A
Resistance value for specified, current-dependent power loss	0.00183 $\Omega$

### Connection data

Connection points	3
Total number of potentials	1
Number of levels	1
Number of jumper slots	2

### Connection 1

Connection technology	Push-in CAGE CLAMP®
Actuation type	Operating tool
Connectable conductor materials	Copper
Nominal cross-section	1.5 mm <sup>2</sup>
Solid conductor	0.25 ... 2.5 mm <sup>2</sup> / 22 ... 14 AWG
Solid conductor; push-in termination	0.75 ... 2.5 mm <sup>2</sup> / 18 ... 14 AWG
Fine-stranded conductor	0.25 ... 2.5 mm <sup>2</sup> / 22 ... 14 AWG
Fine-stranded conductor; with insulated ferrule	0.25 ... 1.5 mm <sup>2</sup> / 22 ... 16 AWG
Fine-stranded conductor; with ferrule; push-in termination	0.75 ... 1.5 mm <sup>2</sup> / 18 ... 16 AWG
Note (conductor cross-section)	Depending on the conductor characteristic, a conductor with a smaller cross-section can also be inserted via push-in termination.
Strip length	9 ... 11 mm / 0.35 ... 0.43 inches
Wiring direction	Front-entry wiring

### Physical data

Width	4.2 mm / 0.165 inches
Height	59.2 mm / 2.33 inches
Depth from upper-edge of DIN-rail	32.9 mm / 1.295 inches

### Mechanical data

Mounting type	DIN-35 rail
Marking level	Center/side marking

### Material data

Note (material data)	<a href="#">Information on material specifications can be found here</a>
Color	orange
Material group	I
Insulation material	Polyamide (PA66)
Flammability class per UL94	V0
Fire load	0.106 MJ
Weight	4.9 g

### Environmental requirements

Processing temperature	-35 ... +85 °C
Continuous operating temperature	-60 ... +105 °C

### Commercial data

Product Group	22 (TOPJOB S)
eCl@ss 10.0	27-14-11-20
eCl@ss 9.0	27-14-11-20
ETIM 8.0	EC000897
ETIM 7.0	EC000897
PU (SPU)	100 pcs
Packaging type	Box
Country of origin	DE
GTIN	4017332998642
Customs tariff number	85369010000

### Environmental Product Compliance

RoHS Compliance Status	Compliant, No Exemption
------------------------	-------------------------

### Approvals / Certificates

#### General approvals



Approval	Standard	Certificate Name
CCA DEKRA Certification B.V.	EN 60947	NTR NL-7963
CSA DEKRA Certification B.V.	C22.2 No. 158	1645434
KEMA/KEUR DEKRA Certification B.V.	EN 60947	71-125954
UL UL International Germany GmbH	UL 1059	E45172

#### Declarations of conformity and manufacturer's declarations



Approval	Standard	Certificate Name
ATEX-Attestation of Conformity WAGO GmbH & Co. KG	-	-
EU-Declaration of Conformity WAGO GmbH & Co. KG	-	-
Railway WAGO GmbH & Co. KG	-	Railway Ready
UK-Declaration of Conformity WAGO GmbH & Co. KG	-	-

#### Approvals for marine applications



Approval	Standard	Certificate Name
ABS American Bureau of Shipping	EN 60947	20-HG1941090-PDA
BV Bureau Veritas S.A.	EN 60947	38586/B0 BV
DNV GL Det Norske Veritas, Germanischer Lloyd	-	TAE00001V2

#### Approvals for hazardous areas



Approval	Standard	Certificate Name
AEx UL International Germany GmbH c/o Physikalisch Technische Bundesanstalt	UL 60079	E185892 (AEx e II resp. Ex e II)
ATEX Physikalisch Technische Bundesanstalt (PTB)	EN 60079	PTB 05 ATEX 1094 U (II 2 G Ex eb IIC Gb bzw. I M 2 Ex eb I Mb)
CCC CNEX	GB/T 3836.3	2020312313000159 (Ex eb IIC Gb, Ex eb I Mb)
EAC Brjansker Zertifizierungsstelle	TP TC 012/2011	RU C-DE.AM02. B.00127/19 (Ex e IIC Gb U)
IECEx Physikalisch Technische Bundesanstalt (PTB)	IEC 60079	IECEx PTB 05. 0034 U (Ex eb IIC Gb or Ex eb I Mb)

Approvals for hazardous areas

INMETRO TÜV Rheinland do Brasil Ltda.	IEC 60079	TÜV 12.1308 U
---	-----------	---------------

Downloads

Environmental Product Compliance

Compliance Search

Environmental Product Compliance 2001-1302	↓
--	---

Documentation

Additional Information

Technical Section	pdf 2142.18 KB	↓
-------------------	-------------------	---

Bid Text

2001-1302	19.02.2019	xml 3.93 KB	↓
2001-1302	02.08.2018	docx 14.76 KB	↓

CAD/CAE-Data

CAD data

2D/3D Models 2001-1302	↓
---------------------------	---

CAE data

EPLAN Data Portal 2001-1302	↓
WSCAD Universe 2001-1302	↓
ZUKEN Portal 2001-1302	↓

1 Compatible Products

1.1 Required Accessories

1.1.1 End plate

1.1.1.1 End plate



**Item No.: 2002-1391**  
End and intermediate plate; 0.8 mm thick; gray



**Item No.: 2002-1392**  
End and intermediate plate; 0.8 mm thick; orange



**Item No.: 209-191**  
Separator for Ex e/Ex i applications; 3 mm thick; 120 mm wide; orange



**Item No.: 2002-1393**  
Seperator plate; 2 mm thick; oversized; gray



**Item No.: 2002-1394**  
Seperator plate; 2 mm thick; oversized; orange

1.2 Optional Accessories

## 1.2.1 DIN-rail

### 1.2.1.1 Mounting accessories



**Item No.: 210-196**

Aluminum carrier rail; 35 x 8.2 mm; 1.6 mm thick; 2 m long; unslotted; similar to EN 60715; silver-colored



**Item No.: 210-198**

Copper carrier rail; 35 x 15 mm; 2.3 mm thick; 2 m long; unslotted; according to EN 60715; copper-colored



**Item No.: 210-197**

Steel carrier rail; 35 x 15 mm; 1.5 mm thick; 2 m long; slotted; similar to EN 60715; silver-colored



**Item No.: 210-114**

Steel carrier rail; 35 x 15 mm; 1.5 mm thick; 2 m long; unslotted; similar to EN 60715; silver-colored



**Item No.: 210-118**

Steel carrier rail; 35 x 15 mm; 2.3 mm thick; 2 m long; unslotted; according to EN 60715; silver-colored



**Item No.: 210-115**

Steel carrier rail; 35 x 7.5 mm; 1 mm thick; 2 m long; slotted; according to EN 60715; "Hole width 18 mm; silver-colored



**Item No.: 210-112**

Steel carrier rail; 35 x 7.5 mm; 1 mm thick; 2 m long; slotted; according to EN 60715; "Hole width 25 mm; silver-colored



**Item No.: 210-113**

Steel carrier rail; 35 x 7.5 mm; 1 mm thick; 2 m long; unslotted; according to EN 60715; silver-colored

## 1.2.2 Ferrule

### 1.2.2.1 Ferrule



**Item No.: 216-241**

Ferrule; Sleeve for 0.5 mm<sup>2</sup> / 20 AWG; insulated; electro-tin plated; electrolytic copper; gastight crimped; acc. to DIN 46228, Part 4/09.90; white



**Item No.: 216-242**

Ferrule; Sleeve for 0.75 mm<sup>2</sup> / 18 AWG; insulated; electro-tin plated; electrolytic copper; gastight crimped; acc. to DIN 46228, Part 4/09.90; gray



**Item No.: 216-243**

Ferrule; Sleeve for 1 mm<sup>2</sup> / AWG 18; insulated; electro-tin plated; electrolytic copper; gastight crimped; acc. to DIN 46228, Part 4/09.90; red



**Item No.: 216-244**

Ferrule; Sleeve for 1.5 mm<sup>2</sup> / AWG 16; insulated; electro-tin plated; electrolytic copper; gastight crimped; acc. to DIN 46228, Part 4/09.90; black

## 1.2.3 Installation

### 1.2.3.1 Cover



**Item No.: 709-156**

Cover; Type 3; suitable for cover carrier, type 3; 1 m long; transparent

### 1.2.3.2 Cover carrier



**Item No.: 709-169**

Cover carrier; Type 3; gray

## 1.2.4 Insulation stop

### 1.2.4.1 Insulation stop



**Item No.: 2001-171**

Insulation stop; 0.25 - 0.5 mm<sup>2</sup>; 5 pieces/strip; light gray

















## 1.2.5 Jumper

1.2.5.1 Jumper

 <b>Item No.: 2001-406/020-000</b> Delta jumper; insulated; light gray	 <b>Item No.: 2001-410</b> Jumper; 10-way; insulated; light gray	 <b>Item No.: 2001-402</b> Jumper; 2-way; insulated; light gray	 <b>Item No.: 2001-403</b> Jumper; 3-way; insulated; light gray
 <b>Item No.: 2001-404</b> Jumper; 4-way; insulated; light gray	 <b>Item No.: 2001-405</b> Jumper; 5-way; insulated; light gray	 <b>Item No.: 2001-406</b> Jumper; 6-way; insulated; light gray	 <b>Item No.: 2001-407</b> Jumper; 7-way; insulated; light gray
 <b>Item No.: 2001-408</b> Jumper; 8-way; insulated; light gray	 <b>Item No.: 2001-409</b> Jumper; 9-way; insulated; light gray	 <b>Item No.: 2001-440</b> Jumper; from 1 to 10; insulated; light gray	 <b>Item No.: 2001-433</b> Jumper; from 1 to 3; insulated; light gray
 <b>Item No.: 2001-434</b> Jumper; from 1 to 4; insulated; light gray	 <b>Item No.: 2001-435</b> Jumper; from 1 to 5; insulated; light gray	 <b>Item No.: 2001-436</b> Jumper; from 1 to 6; insulated; light gray	 <b>Item No.: 2001-437</b> Jumper; from 1 to 7; insulated; light gray
 <b>Item No.: 2001-438</b> Jumper; from 1 to 8; insulated; light gray	 <b>Item No.: 2001-439</b> Jumper; from 1 to 9; insulated; light gray	 <b>Item No.: 2001-405/011-000</b> Star point jumper; 3-way; insulated; light gray	 <b>Item No.: 2006-499</b> Step-down jumper; from 2006/2004 to 2004/2002/2001 series; from 2206/2204 to 2204/2202/2201 series; insulated; light gray
 <b>Item No.: 210-103</b> Wire commoning chain; insulated; black	 <b>Item No.: 210-123</b> Wire commoning chain; insulated; blue		

1.2.6 Marking

1.2.6.1 Marker

 <b>Item No.: 793-4501/000-006</b> WMB marking card; as card; stretchable 4 - 4.2 mm; plain; snap-on type; blue	 <b>Item No.: 793-4501/000-007</b> WMB marking card; as card; stretchable 4 - 4.2 mm; plain; snap-on type; gray	 <b>Item No.: 793-4501/000-023</b> WMB marking card; as card; stretchable 4 - 4.2 mm; plain; snap-on type; green	 <b>Item No.: 793-4501/000-017</b> WMB marking card; as card; stretchable 4 - 4.2 mm; plain; snap-on type; light green
 <b>Item No.: 793-4501/000-012</b> WMB marking card; as card; stretchable 4 - 4.2 mm; plain; snap-on type; orange	 <b>Item No.: 793-4501/000-005</b> WMB marking card; as card; stretchable 4 - 4.2 mm; plain; snap-on type; red	 <b>Item No.: 793-4501/000-024</b> WMB marking card; as card; stretchable 4 - 4.2 mm; plain; snap-on type; violet	 <b>Item No.: 793-4501</b> WMB marking card; as card; stretchable 4 - 4.2 mm; plain; snap-on type; white
 <b>Item No.: 793-4501/000-002</b> WMB marking card; as card; stretchable 4 - 4.2 mm; plain; snap-on type; yellow	 <b>Item No.: 2009-114/000-006</b> WMB-Inline; for Smart Printer; 2000 pieces on roll; stretchable 4 - 4.2 mm; plain; snap-on type; blue	 <b>Item No.: 2009-114/000-007</b> WMB-Inline; for Smart Printer; 2000 pieces on roll; stretchable 4 - 4.2 mm; plain; snap-on type; gray	 <b>Item No.: 2009-114/000-023</b> WMB-Inline; for Smart Printer; 2000 pieces on roll; stretchable 4 - 4.2 mm; plain; snap-on type; green
 <b>Item No.: 2009-114/000-012</b> WMB-Inline; for Smart Printer; 2000 pieces on roll; stretchable 4 - 4.2 mm; plain; snap-on type; orange	 <b>Item No.: 2009-114/000-005</b> WMB-Inline; for Smart Printer; 2000 pieces on roll; stretchable 4 - 4.2 mm; plain; snap-on type; red	 <b>Item No.: 2009-114/000-024</b> WMB-Inline; for Smart Printer; 2000 pieces on roll; stretchable 4 - 4.2 mm; plain; snap-on type; violet	 <b>Item No.: 2009-114</b> WMB-Inline; for Smart Printer; 2000 pieces on roll; stretchable 4 - 4.2 mm; plain; snap-on type; white
 <b>Item No.: 2009-114/000-002</b> WMB-Inline; for Smart Printer; 2000 pieces on roll; stretchable 4 - 4.2 mm; plain; snap-on type; yellow			

1.2.6.2 Marking strip



**Item No.: 2009-110**  
 Marking strips; for Smart Printer; on reel; not stretchable; plain; snap-on type; white

1.2.7 Protective warning marker

1.2.7.1 Cover



**Item No.: 2001-115**  
 Protective warning marker; for 5 terminal blocks; with high-voltage symbol, black; yellow

1.2.8 Push-in type wire jumper

1.2.8.1 Jumper



**Item No.: 2009-414**  
 Push-in type wire jumper; 1.5 mm<sup>2</sup>; insulated; 110 mm long; black



**Item No.: 2009-414/000-005**  
 Push-in type wire jumper; 1.5 mm<sup>2</sup>; insulated; 110 mm long; black



**Item No.: 2009-416**  
 Push-in type wire jumper; 1.5 mm<sup>2</sup>; insulated; 250 mm long; black



**Item No.: 2009-414/000-006**  
 Push-in type wire jumper; insulated; 110 mm long; black



**Item No.: 2009-412**  
 Push-in type wire jumper; insulated; 60 mm long; black

1.2.9 Test and measurement

1.2.9.1 Testing accessories



**Item No.: 2001-560**  
 Modular TOPJOB®S connector; modular; for jumper contact slot; 10-pole; 1,50 mm<sup>2</sup>; gray



**Item No.: 2001-511**  
 Modular TOPJOB®S connector; modular; for jumper contact slot; 1-pole; 1,50 mm<sup>2</sup>; gray



**Item No.: 2001-552**  
 Modular TOPJOB®S connector; modular; for jumper contact slot; 2-pole; 1,50 mm<sup>2</sup>; gray



**Item No.: 2001-553**  
 Modular TOPJOB®S connector; modular; for jumper contact slot; 3-pole; 1,50 mm<sup>2</sup>; gray



**Item No.: 2001-554**  
 Modular TOPJOB®S connector; modular; for jumper contact slot; 4-pole; 1,50 mm<sup>2</sup>; gray



**Item No.: 2001-555**  
 Modular TOPJOB®S connector; modular; for jumper contact slot; 5-pole; 1,50 mm<sup>2</sup>; gray



**Item No.: 2001-556**  
 Modular TOPJOB®S connector; modular; for jumper contact slot; 6-pole; 1,50 mm<sup>2</sup>; gray



**Item No.: 2001-557**  
 Modular TOPJOB®S connector; modular; for jumper contact slot; 7-pole; 1,50 mm<sup>2</sup>; gray



**Item No.: 2001-558**  
 Modular TOPJOB®S connector; modular; for jumper contact slot; 8-pole; 1,50 mm<sup>2</sup>; gray



**Item No.: 2001-559**  
 Modular TOPJOB®S connector; modular; for jumper contact slot; 9-pole; 1,50 mm<sup>2</sup>; gray



**Item No.: 2001-549**  
 Spacer module; modular; e.g., for bridging commoned terminal blocks; gray



**Item No.: 2009-174**  
 Test plug adapter; for 4 mm Ø test plugs; for testing TOPJOB®S rail-mounted terminal blocks; gray



**Item No.: 2009-182**  
 Testing tap; for max. 2.5 mm<sup>2</sup>; tool-free connection for individual test wires 0.08 - 2.5 mm; gray

1.2.10 Tool

### 1.2.10.1 Operating tool



**Item No.: 210-719**

Operating tool; Blade: 2.5 x 0.4 mm; with a partially insulated shaft



**Item No.: 210-648**

Operating tool; Blade: 2.5 x 0.4 mm; with a partially insulated shaft; angled; short



**Item No.: 210-647**

Operating tool; Blade: 2.5 x 0.4 mm; with a partially insulated shaft; multicoloured

## Installation Notes

### Conductor termination



All conductor types at a glance

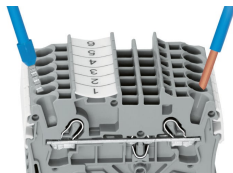

Push-in termination of solid and ferruled conductors

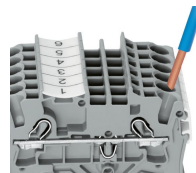

Inserting a conductor via push-in termination:  
Solid conductors with cross-sections from either one size above, or up to two sizes below, the rated cross-section can be simply pushed in – no tools needed.

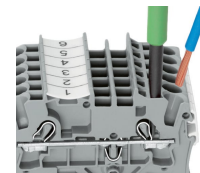

Inserting a conductor via operating tool:  
Connecting fine-stranded conductors without ferrules, or small cross-sectional conductors that cannot be pushed in, is performed similarly to the original CAGE CLAMP® – just use an operating tool.  
Advantage:  
To open the clamp, the operating tool is inserted vertically. The conductor entry is less than 15 degrees for easier wiring.

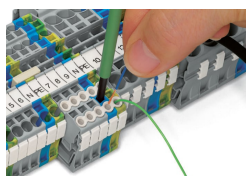

Conductor termination – insulation stop

### Commoning

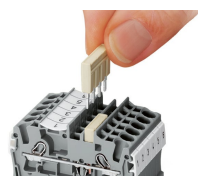

Insert push-in type jumper bar and push down until it hits backstop.

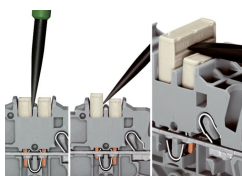

Removing a push-in type jumper bar:  
Insert the operating tool between the jumper and partition wall of the dual jumper slots, then lift up the jumper. Place the operating tool in the center of jumpers for up to five contacts (see above), or alternately on both sides for jumpers with more than five contacts.

### Commoning

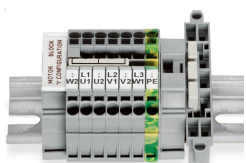

This star point jumper has been specially developed to create a “star point” and is used on motor terminal boards equipped with Rail-Mount Terminal Blocks TOPJOB® S.

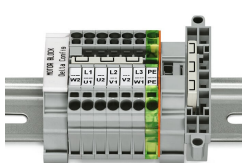

This delta jumper has been specially developed to create a delta configuration and is used on motor terminal boards equipped with rail-mount terminal blocks TOPJOB® S.

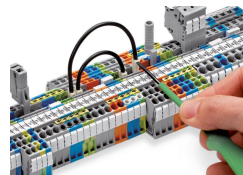

Push down the wire jumper until fully inserted. Lift the jumper with an operating tool for rewiring.



Commoning

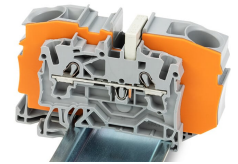
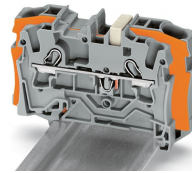
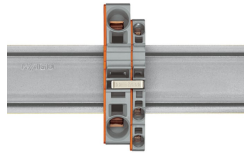
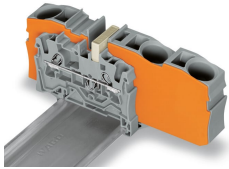

Step-down jumpers common terminal blocks of different sizes, without losing a conductor clamping point. This can be beneficial on long conductor runs where voltage drop can be a problem. A large conductor can be easily connected to smaller conductors at the distribution point. Commoning may be made in either direction using the special thin end plate to cover the open side. Additional through terminal blocks having a smaller cross-section may be commoned using push-in type jumper bars.

Using step-down jumpers, an end plate must be inserted between the terminal blocks to be commoned.

Step-down jumper (2006-499) commons 6/4 mm<sup>2</sup> (10/12 AWG) terminal blocks (2006/2004 Series) with 4/2.5/1.5 mm<sup>2</sup> (AWG 12/14/16) terminal blocks (2004/2002/2001 Series).

Step-down jumper (2016-499) commons 16/10 mm<sup>2</sup> (16/8 AWG) terminal blocks (2016/2010 Series) with 10/6/4/2.5 mm<sup>2</sup> (8/10/12/14 AWG) terminal blocks (2010/2006/2004/2002 Series).

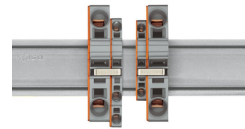
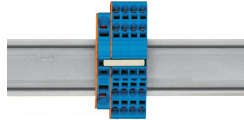
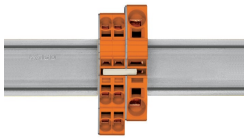

Stepping down via push-in type jumper bar:  
Commoning via open terminal side with end plate allows jumpering over two cross-section sizes for 16 mm<sup>2</sup> (6 AWG) and 10 mm<sup>2</sup> (8 AWG) and one cross-section size for 6/4/2.5 mm<sup>2</sup> (10/12/14 AWG). An example: from 16 mm<sup>2</sup> (6 AWG) to 6 mm<sup>2</sup> (10 AWG) (see illustration above) or from 10 mm<sup>2</sup> (8 AWG) to 4 mm<sup>2</sup> (12 AWG).

Stepping down via push-in type jumper bar:  
Commoning via closed terminal side with end plate allows jumpering over two cross-section sizes, e.g., from 16 mm<sup>2</sup> (6 AWG) to 6 mm<sup>2</sup> (10 AWG) or from 6 mm<sup>2</sup> (10 AWG) to 2.5 mm<sup>2</sup> (14 AWG) (see illustration above).

Note:  
The total current of the outgoing circuits must not exceed the nominal current of the step-down jumper/push-in type jumper bar.

Testing

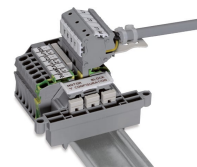
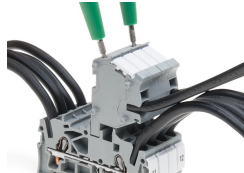

The modular TOPJOB® S connectors also connect conductors of the same size as the terminal blocks being used.

TOPJOB® S Connectors with a 2 mm Ø test socket for testing voltage via 2-pole voltage tester

Rail-mount terminal block assembly for electric motor wiring

Test plug adapter (2009-174, CAT I) for 4 mm Ø plugs – compatible with 2000 to 2016 Series



Testing tap (2009-182) for tool-free connection of test cables up to 2.5 mm<sup>2</sup> (12 AWG) – compatible with 2000 to 2016 Series

Marking

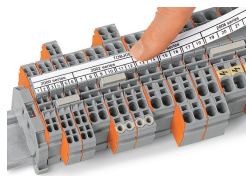
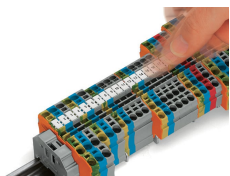

Snapping WMB Inline markers into marker slots.

TOPJOB® S 2009-193 Group Marker Carrier (equipped with a marking strip) for all 2001 to 2016 Series TOPJOB® S Rail-Mount Terminal Blocks  
Do not use on an end plate!

Ex application

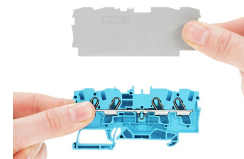
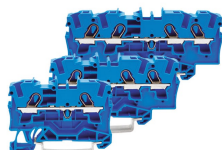
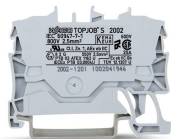

Through terminal blocks with a blue insulated housing are suitable for Ex i applications.

All through and ground conductor terminal blocks are suitable for Ex e II applications.

Separator plate for Ex e/Ex i applications  
An end plate must be applied to the terminal block located directly behind an Ex e/Ex i separator plate.

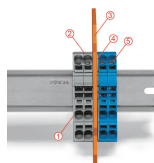
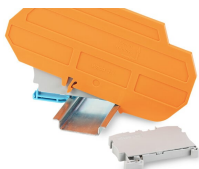

Ex e II/Ex i terminal strip

Note:  
The movable feet of terminal blocks and separator plates must face the same direction.

A separator plate is located between the Ex e II and Ex i terminal strip.

- End plate
- Ex e II terminal blocks
- Separator plate for Ex e/Ex i applications
- End plate
- Ex i terminal blocks

According to EN 50020, a minimum distance of 50 mm must be kept between live parts of Ex e and Ex i circuits. The use of Ex e/Ex i separators is a space-saving solution when Ex e and Ex i terminal blocks are mounted on a common DIN-rail.