

LTM4710-1
Low V_{IN} , Quad 8A Silent Switcher
 μ Module Regulator

DESCRIPTION

Demonstration circuit 3164A-B features the [LTM[®]4710-1](#), a quad DC/DC step-down μ Module[®] regulator with 8A per output, packaged in a compact (6mm × 12mm × 3.54mm) land grid array (LGA) with pre-made solder balls. DC3164A-B has an operating input range of 2.5V to 5.5V. The outputs of the four channels are 0.8V, 1.0V, 1.2V, and 1.5V with 8A per output, respectively. All outputs voltages are programmable from 0.5V up to 3.6V (step-down only). DC3164A-B operates by default at 1.5MHz and can be adjusted by an external resistor from 1MHz to 5MHz or by being synchronized to an external clock from 1.2MHz to 2.6MHz. DC3164A-B also allows for the channels to be paralleled up to 32A load current.

LTM4710-1 integrates four separate constant-frequency peak current mode control regulators, power MOSFETs, inductors, and other supporting discrete components. It employs the second-generation Silent Switcher[®] technology in which it allows fast switching edges for high efficiency at high switching frequencies, while simultaneously achieving good EMI performance. Refer to the LTM4710-1 data sheet for more detailed information.

It is recommended to read the data sheet of the LTM4710-1 prior to making any changes to the DC3164A-B board.

[Design files for this circuit board are available.](#)

All registered trademarks and trademarks are the property of their respective owners.

BOARD PHOTO Part marking is either ink mark or laser mark

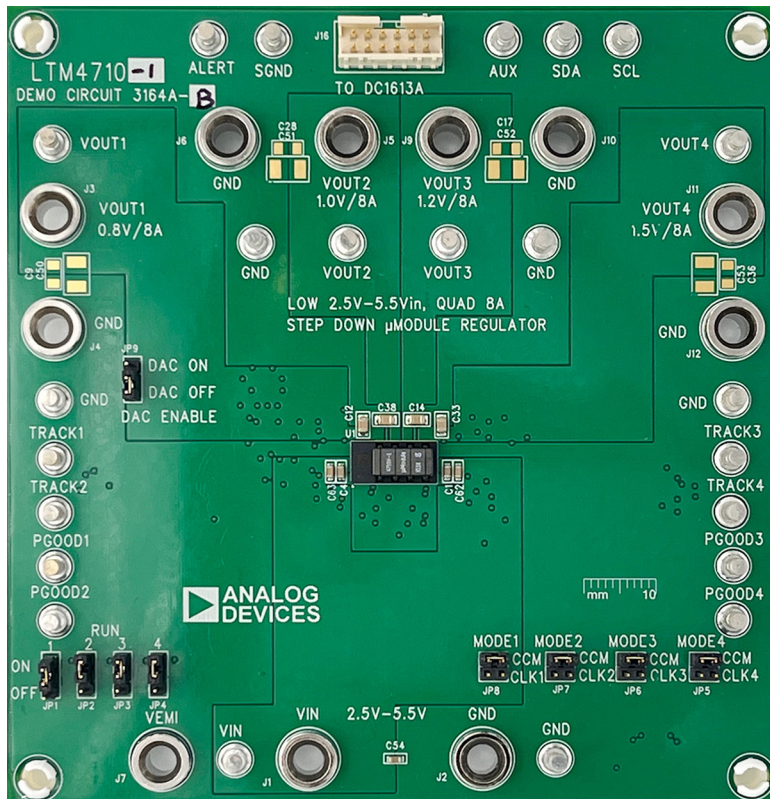

DEMO MANUAL DC3164A-B

PERFORMANCE SUMMARY

Specifications are at $T_A = 25^\circ\text{C}$, no forced-air cooling

PARAMETER	CONDITIONS	MIN	TYP	MAX	UNITS
Input Voltage Range V_{IN}		2.5		5.5	V
Default Switching Frequency			1.5		MHz
Maximum Output Current	For Each Channel		8		A
Output Voltage of Channel 1, V_{OUT1}			0.8		V
Output Voltage of Channel 2, V_{OUT2}			1.0		V
Output Voltage of Channel 3, V_{OUT3}			1.2		V
Output Voltage of Channel 4, V_{OUT4}			1.5		V
Efficiency of Channel 1	$V_{IN} = 3.3\text{V}$, $f_{SW} = 1.5\text{MHz}$, $V_{OUT1} = 0.8\text{V}$, $I_{OUT1} = 8\text{A}$		85.1		%
Efficiency of Channel 2	$V_{IN} = 3.3\text{V}$, $f_{SW} = 1.5\text{MHz}$, $V_{OUT2} = 1.0\text{V}$, $I_{OUT2} = 8\text{A}$		85.8		%
Efficiency of Channel 3	$V_{IN} = 3.3\text{V}$, $f_{SW} = 1.5\text{MHz}$, $V_{OUT3} = 1.2\text{V}$, $I_{OUT3} = 8\text{A}$		87.8		%
Efficiency of Channel 4	$V_{IN} = 3.3\text{V}$, $f_{SW} = 1.5\text{MHz}$, $V_{OUT4} = 1.5\text{V}$, $I_{OUT4} = 8\text{A}$		89.2		%

QUICK START PROCEDURE

Demonstration circuit 3164A-B is easy to set up to evaluate the performance of the LTM4710-1. See Figure 1 for the proper measurement equipment setup and follow the procedure below.

- With power off, place the jumpers as shown in the following positions.

NAME	POSITION	NAME	POSITION
RUN1	ON	MODE1	CCM
RUN2	ON	MODE2	CCM
RUN3	ON	MODE3	CCM
RUN4	ON	MODE4	CCM
DAC ENABLE	OFF		

- With power off, (see Figure 1), connect the input power supply between V_{IN} and GND. Connect the output loads between V_{OUT1} and GND, V_{OUT2} and GND, V_{OUT3} and GND, and V_{OUT4} and GND, respectively.
- Connect the DMMs to the input and outputs.
- Turn on the input power supply.

NOTE: The input voltage should be between 2.5V and 5.5V.

- Check for the proper output voltages. The output voltage meters for each channel should display the programmed output voltages ($V_{OUT1} = 0.8\text{V}$, $V_{OUT2} = 1.0\text{V}$, $V_{OUT3} = 1.2\text{V}$, $V_{OUT4} = 1.5\text{V}$) within $\pm 1.5\%$.
- Once the input and output voltages are properly established, adjust the load current within the operating range of 0A to 8A max for each channel. Observe the output voltage regulation, output voltage ripples, load transient response and other parameters.
- Vary the input voltage from 2.5V to 5.5V. Observe the output voltage regulation.

NOTE: When measuring the output or input voltage ripple, do not use the long ground lead on the oscilloscope probe. See Figure 2 for the proper scope probe technique. Short, stiff leads need to be soldered to the (+) and (-) terminals of an output capacitor. The probe's ground ring needs to touch the (-) lead and the probe tip needs to touch the (+) lead.

OPTIONAL: An input EMI filter is included on the board. To include this filter, connect the input supply positive terminal to VEMI. Connect the input positive supply to V_{IN} to exclude the input EMI filter.

QUICK START PROCEDURE

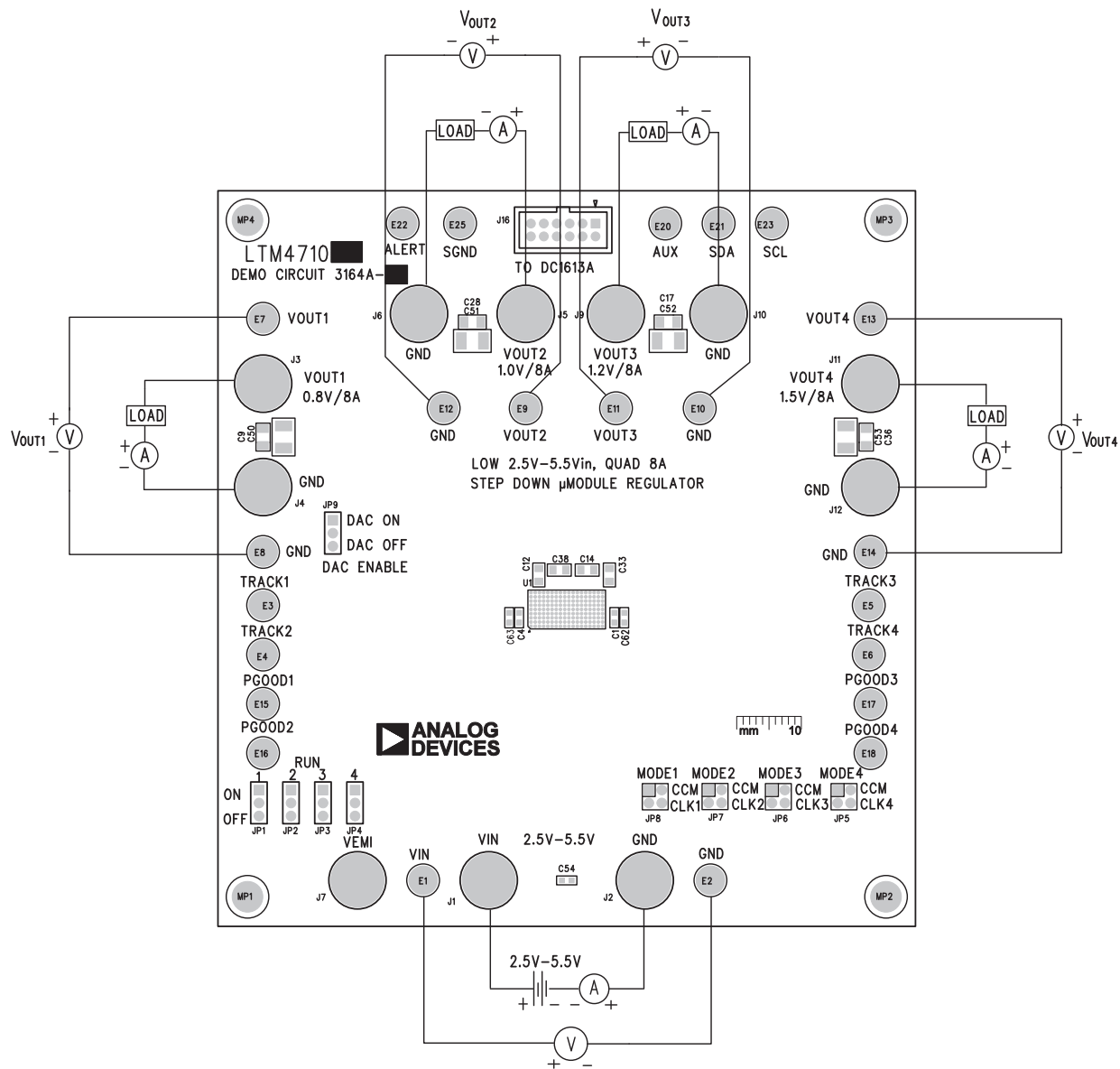

Figure 1. Proper Measurement Equipment Setup

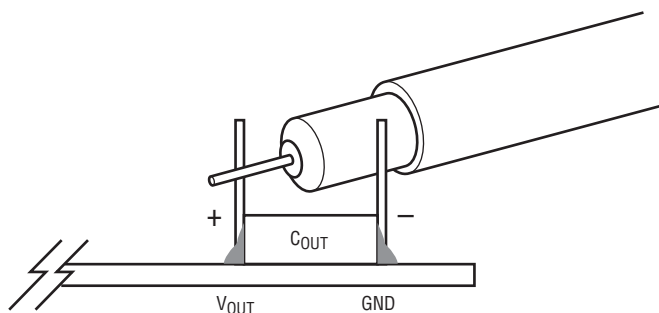

Figure 2. Measuring Output Voltage Ripple

MULTIPHASE CONFIGURATION

For output loads that demand more than 8A of current, multiple LTM4710-1 channels can be paralleled to run out of phase to provide more output current without increasing input and output voltage ripples. Figure 3 shows the typical paralleled application where channel 1 is used as the main channel and the rest of LTM4710-1 channels are programmed as the subordinate channels to achieve the same switching frequency, interleaved phase shift and current sharing among different channels.

The RT pin of the main phase is connected to a resistor to AGND, programming the frequency and configuring

the MODE pin to become clock output used to drive the MODE pin of the subordinate phase(s).

Connecting the FB pin to V_{IN} configures a phase as a subordinate phase. The MODE becomes an input, and the voltage control loop is disabled. The subordinate phase current control loop is still active, and the peak current is controlled via the shared COMP node. The phase shift of a subordinate phase relative to the main phase is programmed with a resistor divider on the RT pin. Refer to the LTM4710-1 data sheet for more detailed information.

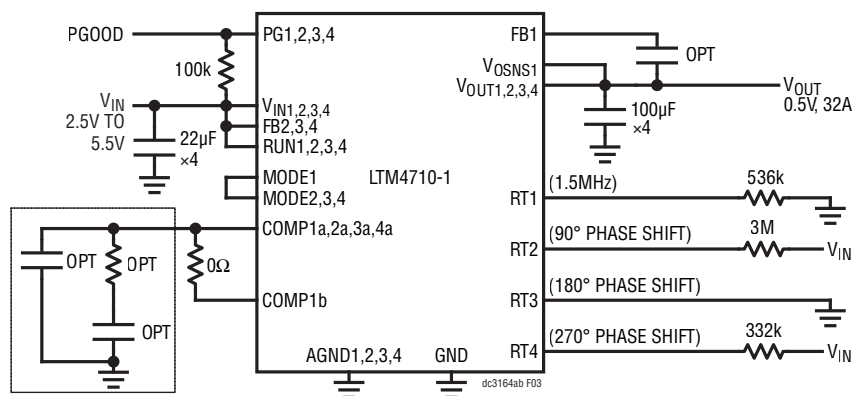

PINS NOT SHOWN IN THIS CIRCUIT: SSTT, SW; COMP2b, COMP3b, COMP4b NO CONNECTION.

Figure 3. Paralleled Single Output, 0.5V, 32A DC/DC μ Module Regulator

TYPICAL PERFORMANCE CHARACTERISTICS

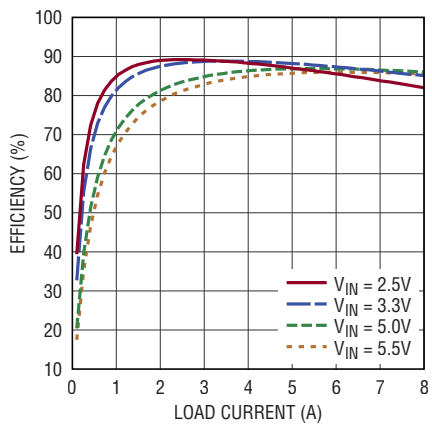

(a) $V_{OUT1} = 0.8V$

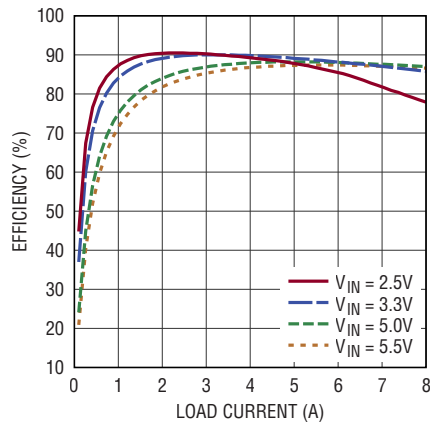

(b) $V_{OUT2} = 1.0V$

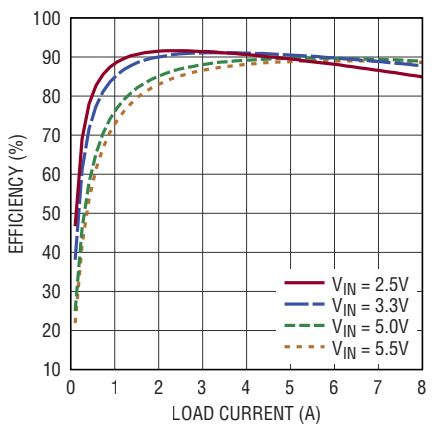

(c) $V_{OUT3} = 1.2V$

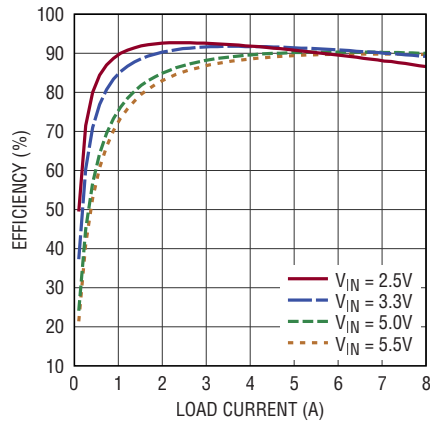

(d) $V_{OUT4} = 1.5V$

Figure 4. Measured Efficiency of Each Channel ($f_{SW} = 1.5MHz$), No Forced Air Cooling with $T_A = 25^\circ C$

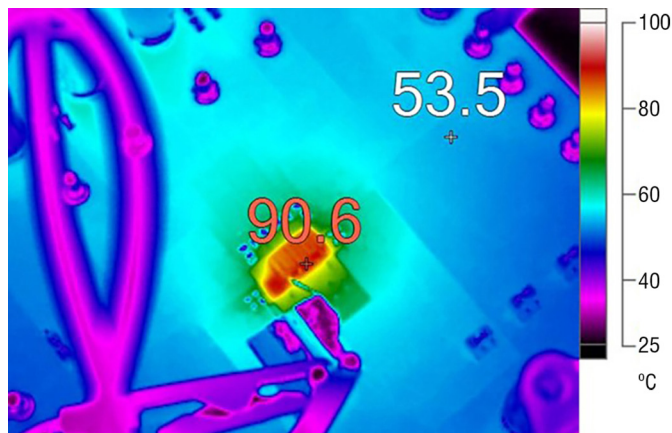
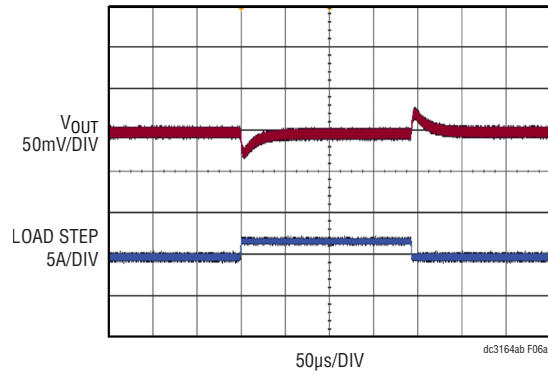
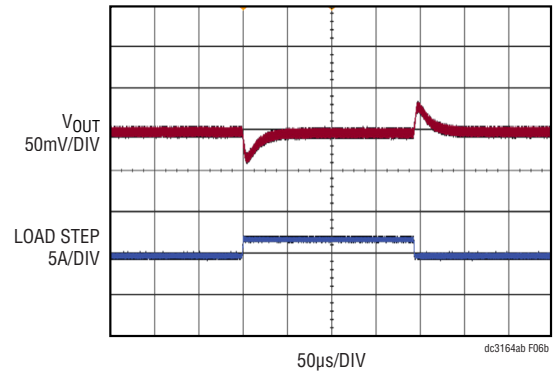

Figure 5. Thermal Performance of 0.8V, 1.0V, 1.2V, and 1.5V with 8A per Output ($V_{IN} = 3.3V$, $f_{SW} = 1.5MHz$), $T_A = 25^\circ C$, No Forced Air Cooling

TYPICAL PERFORMANCE CHARACTERISTICS



(a) $V_{OUT1} = 0.8V$



(b) $V_{OUT2} = 1.0V$

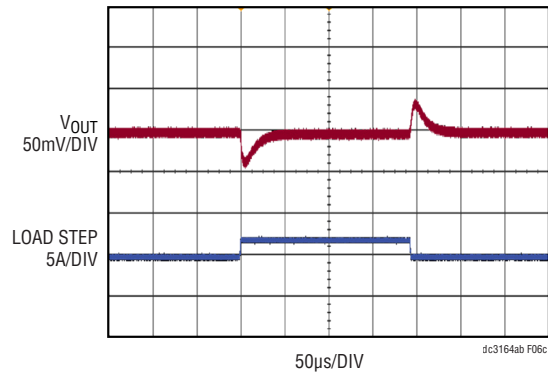

(c) $V_{OUT3} = 1.2V$

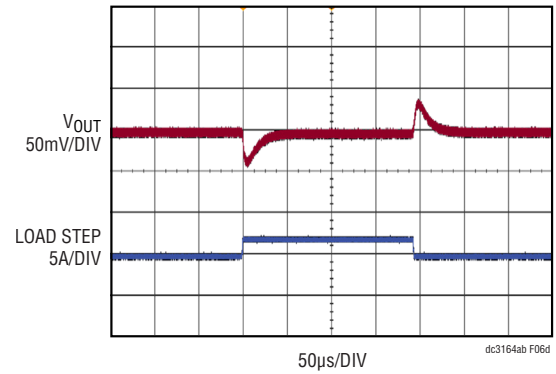

(d) $V_{OUT4} = 1.5V$

Figure 6. Load Transient Responses with Load Steps 0A to 2A to 0A, $di/dt = 2A/\mu s$ ($V_{IN} = 3.3V$, $f_{SW} = 1.5MHz$)

TYPICAL PERFORMANCE CHARACTERISTICS

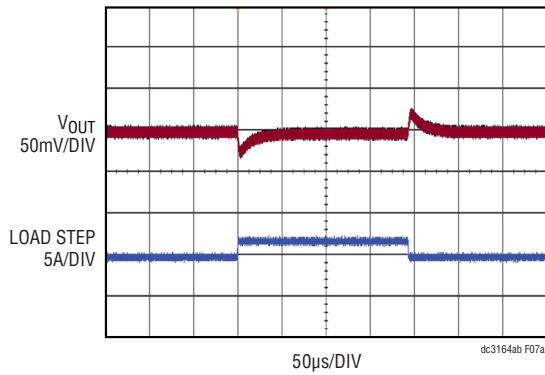

(a) $V_{OUT1} = 0.8V$

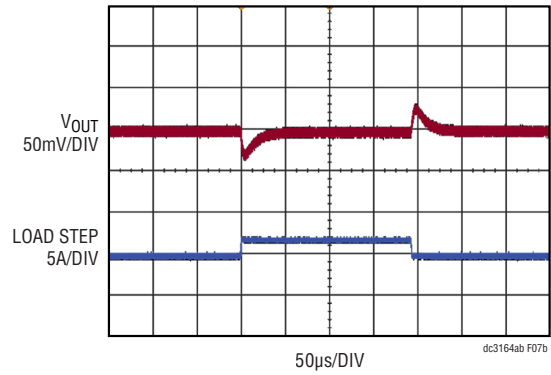

(b) $V_{OUT2} = 1.0V$

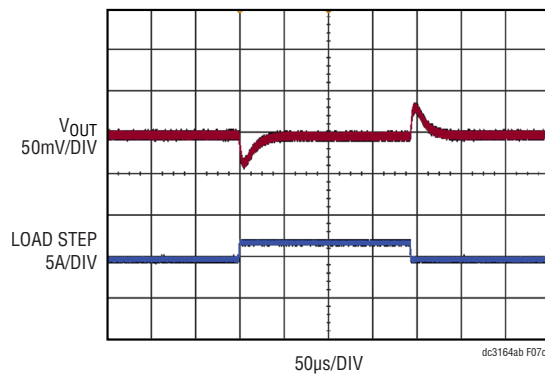

(c) $V_{OUT3} = 1.2V$

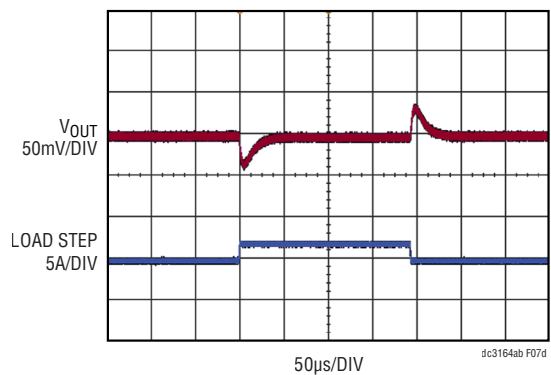

(d) $V_{OUT4} = 1.5V$

Figure 7. Load Transient Responses with Load Steps 6A to 8A to 6A, $di/dt = 2A/\mu s$ ($V_{IN} = 3.3V$, $f_{SW} = 1.5MHz$)

TYPICAL PERFORMANCE CHARACTERISTICS

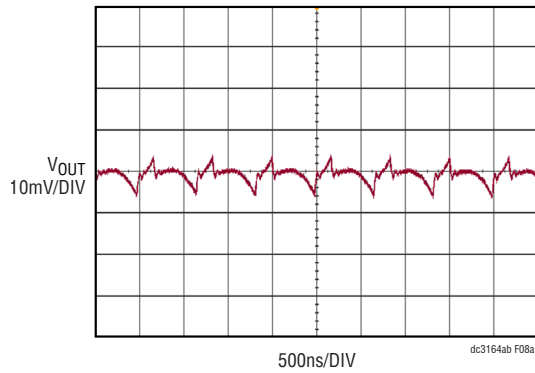

(a) $V_{OUT1} = 0.8V$, $I_{OUT1} = 8A$

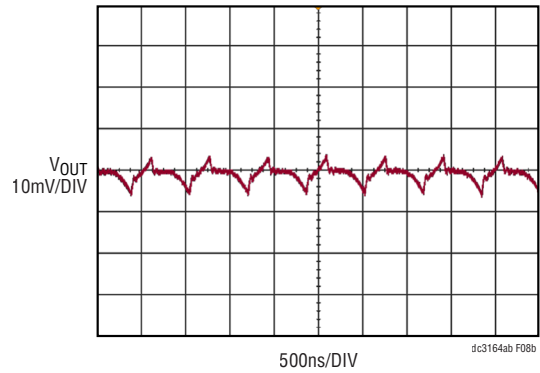

(b) $V_{OUT2} = 1.0V$, $I_{OUT2} = 8A$

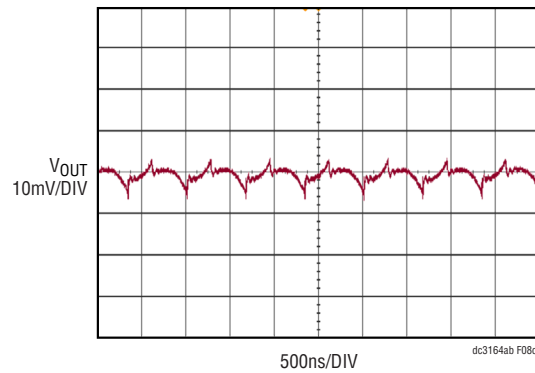

(c) $V_{OUT3} = 1.2V$, $I_{OUT3} = 8A$

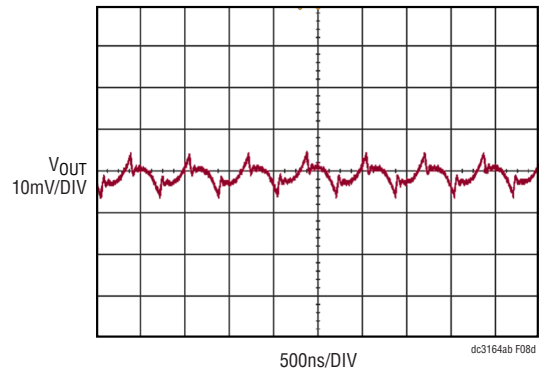

(d) $V_{OUT4} = 1.5V$, $I_{OUT4} = 8A$

Figure 8. Output Voltage Ripple ($V_{IN} = 3.3V$, $f_{SW} = 1.5MHz$, 350MHz BW)

PARTS LIST

ITEM	QTY	REFERENCE	PART DESCRIPTION	MANUFACTURER/PART NUMBER
Required Circuit Components				
1	12	C1, C3-C5, C18-C19, C47-C49, C54, C62-C63	CAP., 22 μ F, X5R, 10V, 20%, 0603	SAMSUNG, CL10A226MP8NUNE
2	1	C2	CAP., 150 μ F, ALUM POLY, OS-CON, 10V, 20%, 8mm \times 6.9mm, E7, SMD, RADIAL, SVP	PANASONIC, 10SVP150MX
3	5	C8, C25-C26, C45-C46	CAP., 0.1 μ F, X7R, 50V, 10%, 0603	TDK, C1608X7R1H104K080AA
4	4	C10, C16, C29, C35	CAP., 22 μ F, X5R, 6.3V, 20%, 0805	TDK, C2012X5R0J226M125AC
5	4	C11, C15, C30, C34	CAP., 47 μ F, X5R, 6.3V, 20%, 0603, NO SUBS. ALLOWED	MURATA, GRM188R60J476ME15D
6	4	C12, C14, C33, C38	CAP., 100 μ F, X6S, 4V, 20%, 0805	MURATA, GRM21BC80G107ME15L
7	2	C55, C56	CAP., 47 μ F, X5R, 10V, 20%, 0805	TDK, C2012X5R1A476M125AC
8	4	CFFW1, CFFW2, CFFW3, CFFW4	CAP., 68pF, C0G, 25V, 10%, 0603	KEMET, C0603C680K3GACTU
9	15	R1-R2, R7-R8, R14-R16, R72, R78-R81, R85, R88, R90	RES., 0 Ω , 1/10W, 0603, AEC-Q200	PANASONIC, ERJ3GEY0R00V
10	1	R3	RES., 16.5k, 1%, 1/10W, 0603, AEC-Q200	VISHAY, CRCW060316K5FKEA
11	8	R27, R29-R31, R68, R69-R71	RES., 10k, 5%, 1/10W, 0603	YAGEO, RC0603JR-0710KL
12	4	R60-R63	RES., 10 Ω , 1%, 1/10W, 0603	YAGEO, RC0603FR-0710RL
13	4	RBT2, RTP2, RTP3, RTP4	RES., 10k, 1%, 1/10W, 0603	YAGEO, RC0603FR-0710KL
14	1	RBT3	RES., 7.15k, 1%, 1/10W, 0603, AEC-Q200	PANASONIC, ERJ3EKF7151V
15	1	RBT4	RES., 4.99k, 1%, 1/10W, 0603, AEC-Q200	PANASONIC, ERJ3EKF4991V
16	1	RSET1	RES., 24.9k, 1%, 1/10W, 0603, AEC-Q200	PANASONIC, ERJ3EKF2492V
17	1	RT1	RES., 536k, 1%, 1/10W, 0603, AEC-Q200	PANASONIC, ERJ3EKF5363V
18	1	L1	IND., 98 Ω AT100MHz, FERRITE BEAD, 25%, 18A, 0.9m Ω , 1LN, 7847	WURTH ELEKTRONIK, 7427932
19	1	U1	IC, LOW V_{IN} QUAD 8A Silent Switcher μ Module, BGA	ANALOG DEVICES, LTM4710EV-1#PBF
20	1	U2	IC, MULTIPHASE OSC WITH FREQ MOD, MSOP-10	ANALOG DEVICES, LTC6902CMS#PBF
Additional Demo Board Circuit Components				
1	0	C9, C17, C28, C36	CAP., OPTION, 1206	
2	0	C50-C53, C57-C60	CAP., OPTION, 1210	
3	0	C61	CAP., OPTION, 0805	
4	0	CITH1-CITH4, CITHP1-CITHP4	CAP., OPTION, 0603	
5	0	R9-R10, R13, R17-R18, R32-R35, R37-R40, R42- R45, R65-R66, R77, R82-R83, R91-R94, RITH1-RITH4, RMOD1, RT2-RT4	RES., OPTION, 0603	
6	0	R36, R41, R46	RES., OPTION, 2512	
7	0	R95-R98	RES., OPTION, 2010	

DEMO MANUAL DC3164A-B

PARTS LIST

ITEM	QTY	REFERENCE	PART DESCRIPTION	MANUFACTURER/PART NUMBER
Hardware for Demo Board Only				
1	23	E1-E18, E20-E23, E25	TEST POINT, TURRET, 0.094" MTG. HOLE, PCB 0.062" THK	MILL-MAX, 2501-2-00-80-00-00-07-0
2	11	J1-J7, J9-J12	CONN., BANANA JACK, FEMALE, THT, NON-INSULATED, SWAGE, 0.218"	KEYSTONE, 575-4
3	1	J16	CONN., HDR, SHROUDED, MALE, 2x6, 2mm, VERT, ST, THT	AMPHENOL, 98414-G06-12ULF
4	5	JP1-JP4, JP9	CONN., HDR, MALE, 1x3, 2mm, VERT, ST, THT, NO SUBS. ALLOWED	WURTH ELEKTRONIK, 62000311121
5	4	JP5-JP8	CONN., HDR, MALE, 2x2, 2mm, VERT, ST, THT, 10 μ Au	SAMTEC, TMM-102-02-L-D
6	4	MP1-MP4	STANDOFF, NYLON, SNAP-ON, 0.25" (6.4mm)	KEYSTONE, 8831
7	1	PCB1	PCB, DC3164A	ANALOG DEVICES APPROVED SUPPLIER, 600-DC3164A
8	9	XJP1-XJP9	CONN., SHUNT, FEMALE, 2-POS, 2mm	WURTH ELEKTRONIK, 60800213421

SCHEMATIC DIAGRAM

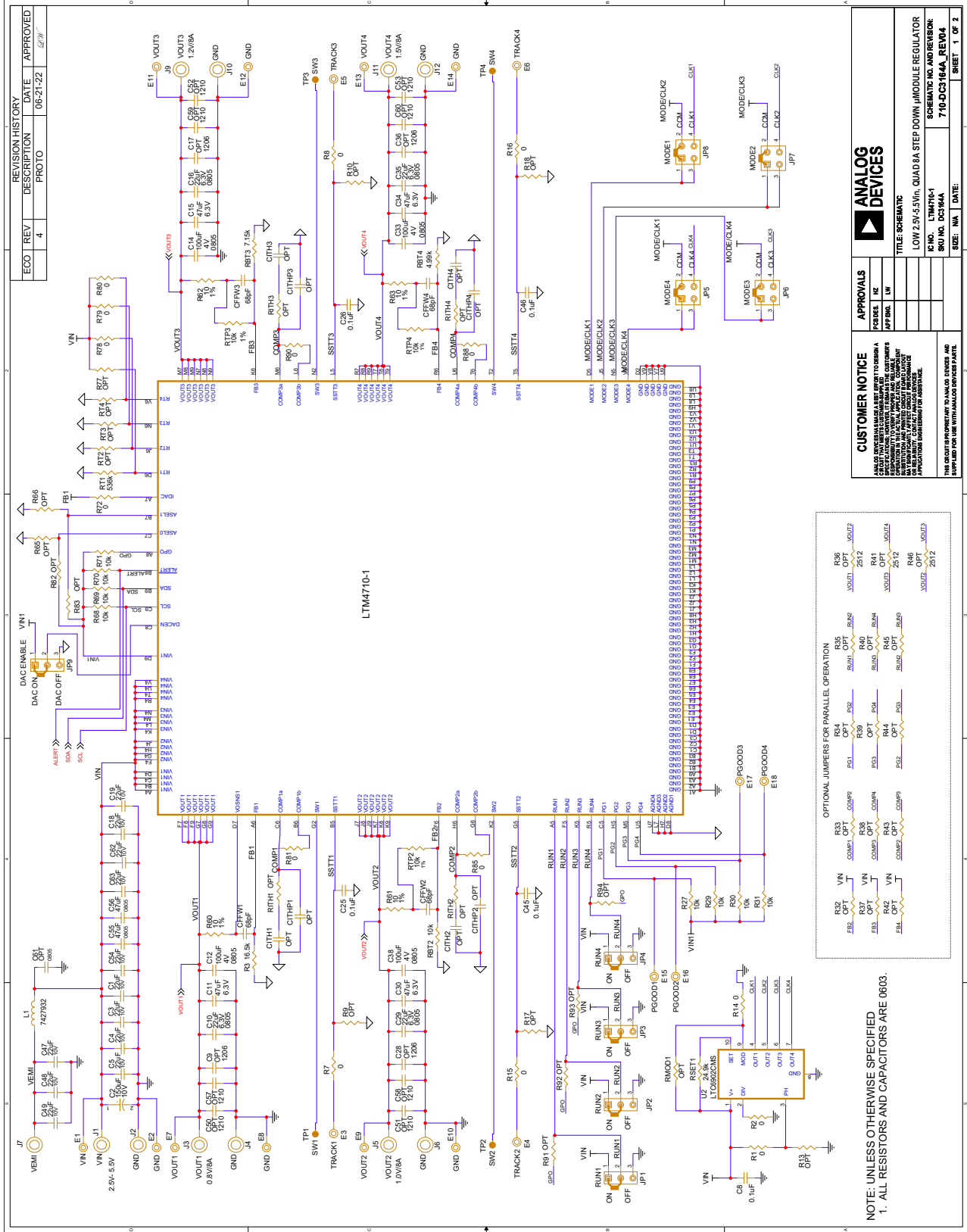

SCHEMATIC DIAGRAM

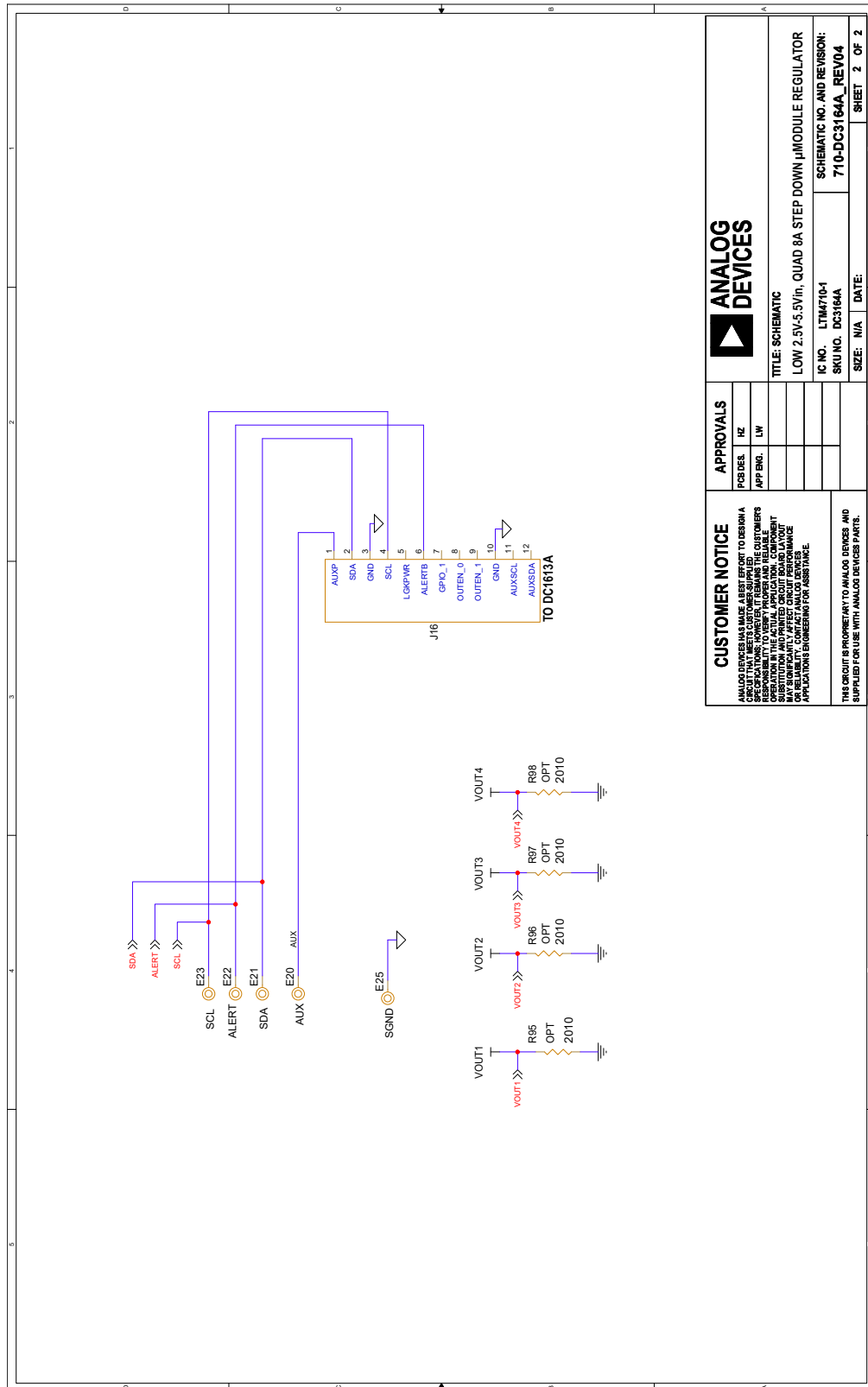

		APPROVALS	
		PCS DESK	IZ
CUSTOMER NOTICE ANALOG DEVICES HAS MADE A BEST EFFORT TO DESIGN A SPECIFIC BOARD, HOWEVER, IT REMAINS THE CUSTOMER'S RESPONSIBILITY TO VERIFY THE BOARD DESIGN, COMPONENT SUBSTITUTION, AND PRINTED CIRCUIT BOARD LAYOUT AGAINST THE ACTUAL APPLICATION COMPONENT OR RELIABILITY. CONTACT ANALOG DEVICES APPLICATIONS ENGINEERING FOR ASSISTANCE.		APP ENG	LW
		TITLE: SCHEMATIC LOW 2.5V-5.5V/in, QUAD 8A STEP DOWN μ MODULE REGULATOR	
THIS CIRCUIT IS PROPRIETARY TO ANALOG DEVICES AND SUPPLIED FOR USE WITH ANALOG DEVICES PARTS.		SCHEMATIC NO. AND REVISION: 710-DC3164A_REV04 SHEET 2 OF 2	

REVISION HISTORY

REV	DATE	DESCRIPTION	PAGE NUMBER
0	07/23	Initial Release.	—



ESD Caution

ESD (electrostatic discharge) sensitive device. Charged devices and circuit boards can discharge without detection. Although this product features patented or proprietary protection circuitry, damage may occur on devices subjected to high energy ESD. Therefore, proper ESD precautions should be taken to avoid performance degradation or loss of functionality.

Legal Terms and Conditions

By using the evaluation board discussed herein (together with any tools, components documentation or support materials, the "Evaluation Board"), you are agreeing to be bound by the terms and conditions set forth below ("Agreement") unless you have purchased the Evaluation Board, in which case the Analog Devices Standard Terms and Conditions of Sale shall govern. Do not use the Evaluation Board until you have read and agreed to the Agreement. Your use of the Evaluation Board shall signify your acceptance of the Agreement. This Agreement is made by and between you ("Customer") and Analog Devices, Inc. ("ADI"), with its principal place of business at One Technology Way, Norwood, MA 02062, USA. Subject to the terms and conditions of the Agreement, ADI hereby grants to Customer a free, limited, personal, temporary, non-exclusive, non-sublicensable, non-transferable license to use the Evaluation Board FOR EVALUATION PURPOSES ONLY. Customer understands and agrees that the Evaluation Board is provided for the sole and exclusive purpose referenced above, and agrees not to use the Evaluation Board for any other purpose. Furthermore, the license granted is expressly made subject to the following additional limitations: Customer shall not (i) rent, lease, display, sell, transfer, assign, sublicense, or distribute the Evaluation Board; and (ii) permit any Third Party to access the Evaluation Board. As used herein, the term "Third Party" includes any entity other than ADI, Customer, their employees, affiliates and in-house consultants. The Evaluation Board is NOT sold to Customer; all rights not expressly granted herein, including ownership of the Evaluation Board, are reserved by ADI. CONFIDENTIALITY. This Agreement and the Evaluation Board shall all be considered the confidential and proprietary information of ADI. Customer may not disclose or transfer any portion of the Evaluation Board to any other party for any reason. Upon discontinuation of use of the Evaluation Board or termination of this Agreement, Customer agrees to promptly return the Evaluation Board to ADI. ADDITIONAL RESTRICTIONS. Customer may not disassemble, decompile or reverse engineer chips on the Evaluation Board. Customer shall inform ADI of any occurred damages or any modifications or alterations it makes to the Evaluation Board, including but not limited to soldering or any other activity that affects the material content of the Evaluation Board. Modifications to the Evaluation Board must comply with applicable law, including but not limited to the RoHS Directive. TERMINATION. ADI may terminate this Agreement at any time upon giving written notice to Customer. Customer agrees to return to ADI the Evaluation Board at that time. LIMITATION OF LIABILITY. THE EVALUATION BOARD PROVIDED HEREUNDER IS PROVIDED "AS IS" AND ADI MAKES NO WARRANTIES OR REPRESENTATIONS OF ANY KIND WITH RESPECT TO IT. ADI SPECIFICALLY DISCLAIMS ANY REPRESENTATIONS, ENDORSEMENTS, GUARANTEES, OR WARRANTIES, EXPRESS OR IMPLIED, RELATED TO THE EVALUATION BOARD INCLUDING, BUT NOT LIMITED TO, THE IMPLIED WARRANTY OF MERCHANTABILITY, TITLE, FITNESS FOR A PARTICULAR PURPOSE OR NON-INFRINGEMENT OF INTELLECTUAL PROPERTY RIGHTS. IN NO EVENT WILL ADI AND ITS LICENSORS BE LIABLE FOR ANY INCIDENTAL, SPECIAL, INDIRECT, OR CONSEQUENTIAL DAMAGES RESULTING FROM CUSTOMER'S POSSESSION OR USE OF THE EVALUATION BOARD, INCLUDING BUT NOT LIMITED TO LOST PROFITS, DELAY COSTS, LABOR COSTS OR LOSS OF GOODWILL. ADI'S TOTAL LIABILITY FROM ANY AND ALL CAUSES SHALL BE LIMITED TO THE AMOUNT OF ONE HUNDRED US DOLLARS (\$100.00). EXPORT. Customer agrees that it will not directly or indirectly export the Evaluation Board to another country, and that it will comply with all applicable United States federal laws and regulations relating to exports. GOVERNING LAW. This Agreement shall be governed by and construed in accordance with the substantive laws of the Commonwealth of Massachusetts (excluding conflict of law rules). Any legal action regarding this Agreement will be heard in the state or federal courts having jurisdiction in Suffolk County, Massachusetts, and Customer hereby submits to the personal jurisdiction and venue of such courts. The United Nations Convention on Contracts for the International Sale of Goods shall not apply to this Agreement and is expressly disclaimed.