

03 0364

Circular connectors with threaded joint M16 acc. to IEC 61076-2-106, IP40/IP68



Crimp contact, contact bush gold-plated

03 0364

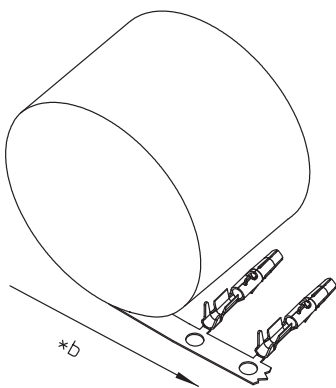
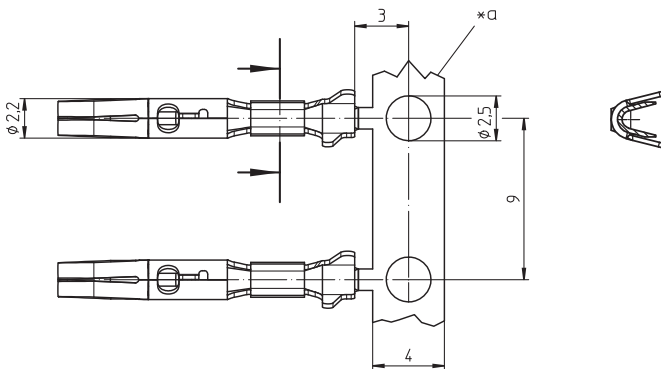
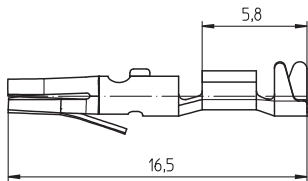

*a supporting strip
*b unreeling direction

Environmental conditions

Temperature range -40 °C/+85 °C

Materials

Contact bush CuSn, gold-plated – 0364 V109

Mechanical data

Mating cycles ≥ 1000
Insertion force/contact $\leq 3.0 \text{ N}^1$
Withdrawal force/contact $\geq 1.2 \text{ N}^1$

¹ measured with a polished steel pin, nominal thickness 1.5 mm

Connectable conductors for crimp area









Section 0,25–0,75 mm² (AWG 23–18)
Insulation diameter $\leq 1,8 \text{ mm}$

Electrical data (at T_{amb} 20 °C)







Contact resistance $\leq 5 \text{ m}\Omega$
Rated current 5 A (T_{amb} 40 °C)
Rated voltage 250/320 V AC
Further data see suitable connector housing

Associated products

Accessories

 0360	 036000	 0362
 036297	 0363	 KfV ... C
 KGV ... C	 KV ... C	 KV ...-8 C
 WKV ... C		

Harnessing equipment

 CAW03	 CZB03-0364	 CZK03
 VARICON 7000-DC-CR	 VARICON 7000-Eco-CR	 VARICON 7000-Inline-CR
 VARICON 7000-RD-CR		

03

0364

Designation	Pole Number	PU (Pieces)	MDQ (Pieces)
0364 V109	1	10000	10000
0364 V109VP18	1	350	1750

Packaging:
on reel