

Active GNSS Dual-Band Stacked Patch Antenna

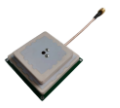

APKG5012GD

Request Samples



Check Inventory



50 x 50 x 12 mm

RoHS N/A

MSL Level = N/A

Features

- Multiband Multi-Constellation Active GNSS Antenna
 - GPS : L1/L5
 - GLONASS : G1
 - Galileo : E1/E5a
 - Beidou : B1/B2a/B2b
 - IRNSS : L5
 - SBAS : L1/L5
- High LNA gain of 40 ± 2 dB with low noise figure
- Very low noise figure (< 1.5 dB)
- Good performance from 3.3 to 10 VDC
- Excellent multipath and interference rejection

Applications

- Autonomous driving and UAVs
- Precision land survey positioning
- Surveying and mapping systems
- Precision agriculture
- Tri-band RTK and PPP receivers
- Mission-critical GNSS timing
- Geofencing

Product Image

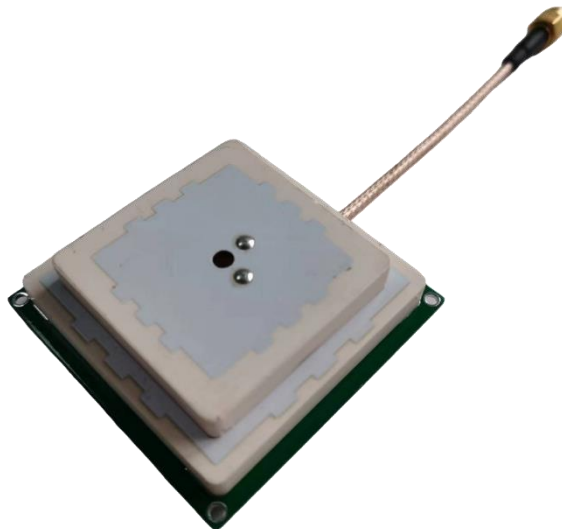

Active GNSS Dual-Band Stacked Patch Antenna

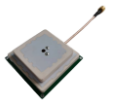

APKG5012GD

Request Samples



Check Inventory



50 x 50 x 12 mm

RoHS N/A

MSL Level = N/A

GNSS Frequency Bands Covered

GPS	L1 1575.42MHz	L2 1227.6MHz	L5 1176.45MHz	
	■	□	■	
GLONASS	G1 1598.06-1609.31MHz	G2 1242.93-1251.68MHz	G3 1202.025MHz	
	■	□	□	
Galileo	E1 1575.42MHz	E5a 1176.45MHz	E5b 1201.5MHz	E6 1278.75MHz
	■	■	□	□
BeiDou	B1 1561MHz	B2 1207.14MHz	B3 1268.52MHz	
	■	□	□	
QZSS	L1 1575.42MHz	L2 1227.6MHz	L5 1176.45MHz	L6 1278.75MHz
	■	□	■	□
IRNSS/NAVIC			L5 1176.45MHz	
			■	
SBAS	L1/E1/B1 1575.42MHz		L5/B2a/E5a 1176.45MHz	
	■		■	

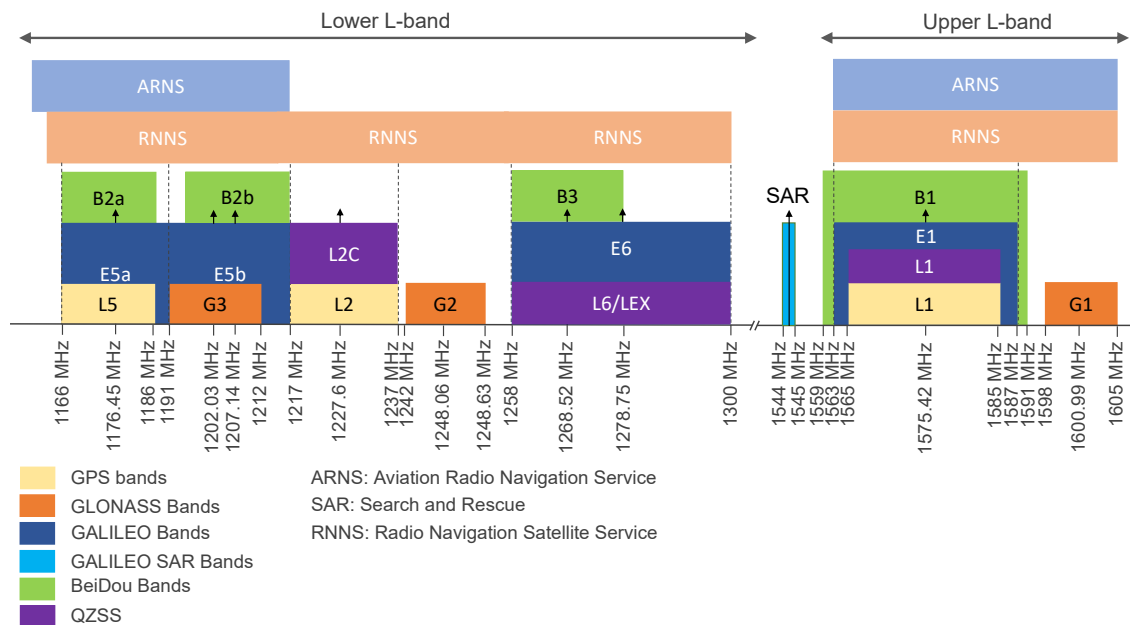

Frequency allocation: GNSS systems, upper L bands and lower L bands



5101 Hidden Creek Ln Spicewood TX 78669
 Phone: 512-371-6159 | Fax: 512-351-8858
 For terms and conditions of sales, please visit:
www.abracon.com

REVISED: 04-26-23

ABRACON IS
 ISO9001-2015
 CERTIFIED

Active GNSS Dual-Band Stacked Patch Antenna

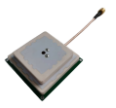

APKG5012GD

Request Samples



Check Inventory



50 x 50 x 12 mm

RoHS N/A

MSL Level = N/A

Electrical Specification

Parameters	Typ.	Units	Note
Antenna			
Frequency	GPS : L1/L5 GLONASS : G1 Galileo : E1/E5a Beidou : B1/B2a IRNSS : L5 SBAS : L1/L5		
VSWR	≤ 2	-	
Polarization	RHCP	-	(Right Hand Circular Polarization)
Nominal Impedance	50	Ω	
LNA			
Gain RHCP (maximum)			
1575.42 MHz	4.0	dBic	GPS L1
1176.45 MHz	> 3.5		GPS L5
Noise Figure	≤ 1.5	dB	
Gain	40 ± 2	dB	
VSWR	≤ 2.0	-	
Operating Voltage	+3.3 ~ +10	V	
Current Consumption	34 ± 3	mA	
Out-Of-Band Rejection	55	dB	

Active GNSS Dual-Band Stacked Patch Antenna

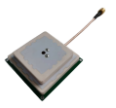

APKG5012GD

Request Samples



Check Inventory



50 x 50 x 12 mm

RoHS N/A

MSL Level = N/A

Mechanical Specifications

Parameter	Specification
Antenna Dimension	50 x 50 x 12 mm
Antenna Material	Dielectric Ceramics
Ground Material	1mm FR-4
Shield Cover	0.2mm Tinplate
RF Connector	SMA-J (M)
RF Cable	RG316,105mm

Environmental Specification

Parameter	Specification
Operating Temperature	-40°C to +85°C
Storage Temperature	-45°C to +85°C
RoHS Compliance	Yes
Relative Humidity	95% @ 65°C

Active GNSS Dual-Band Stacked Patch Antenna

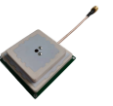

APKG5012GD

Request Samples



Check Inventory



50 x 50 x 12 mm

RoHS N/A

MSL Level = N/A

Product Dimensions

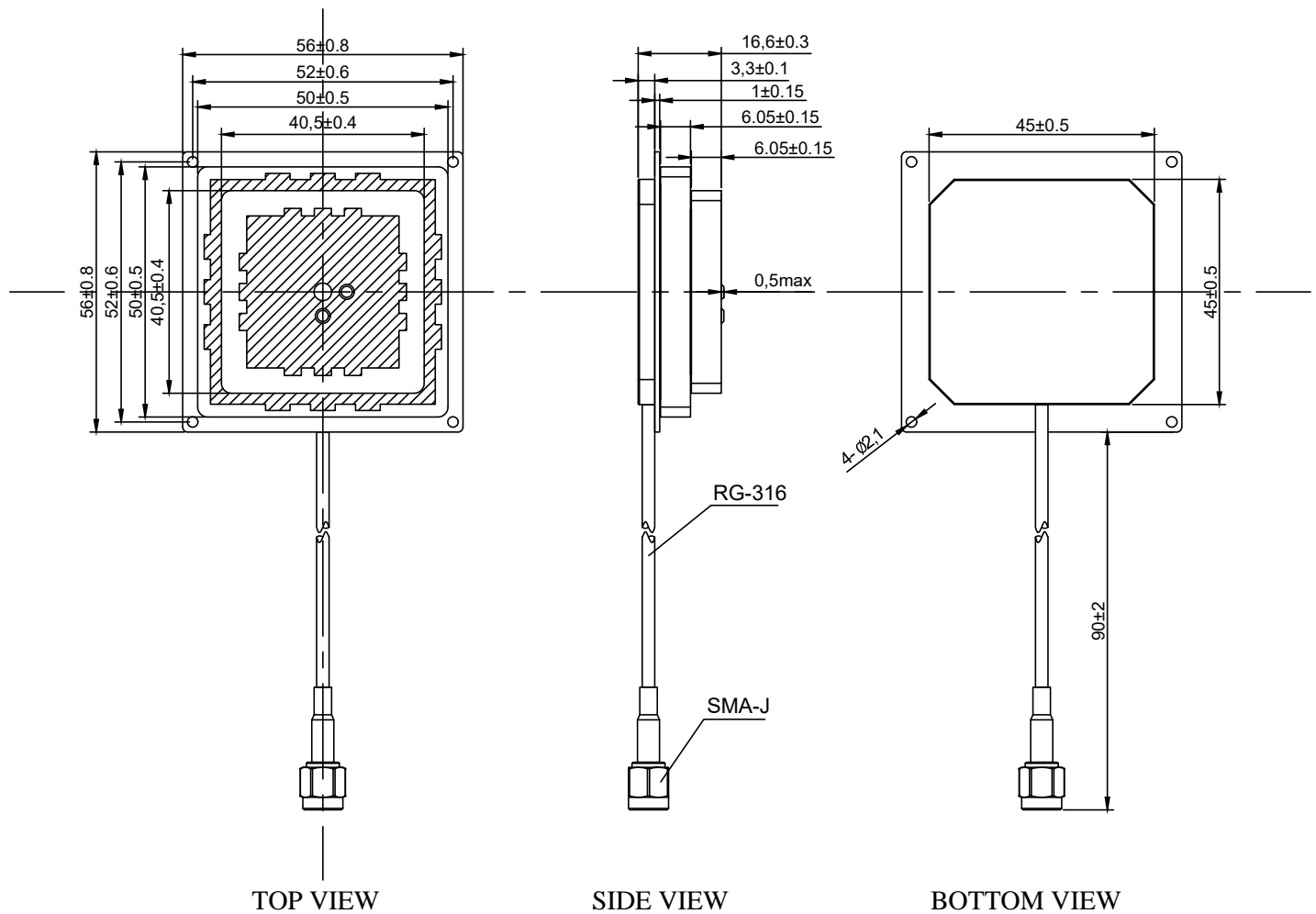

Unit: mm

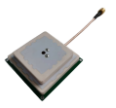

APKG5012GD

Request Samples



Check Inventory



50 x 50 x 12 mm

RoHS N/A

MSL Level = N/A

Reflection Characteristics – VSWR & Return Loss

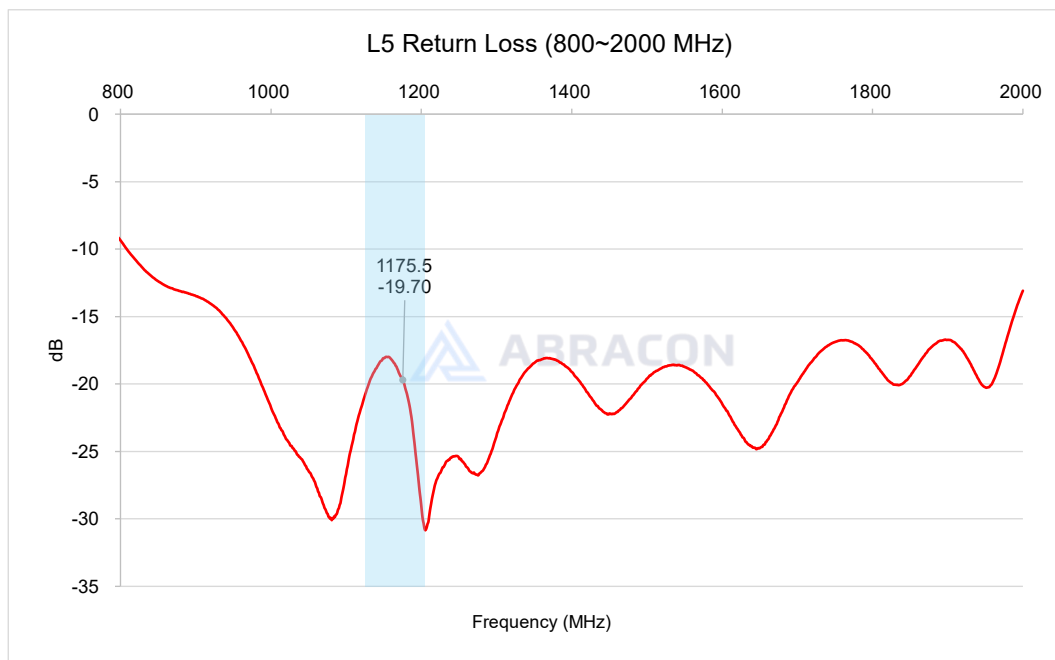
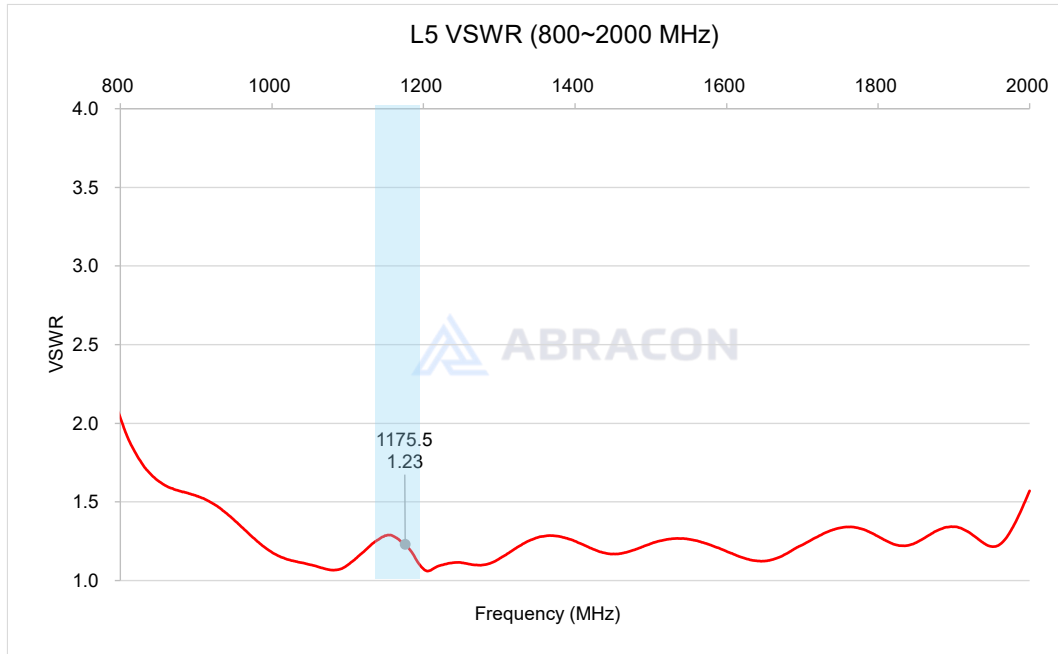

Active GNSS Dual-Band Stacked Patch Antenna

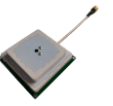

APKG5012GD

Request Samples



Check Inventory



50 x 50 x 12 mm
RoHS N/A
MSL Level = N/A

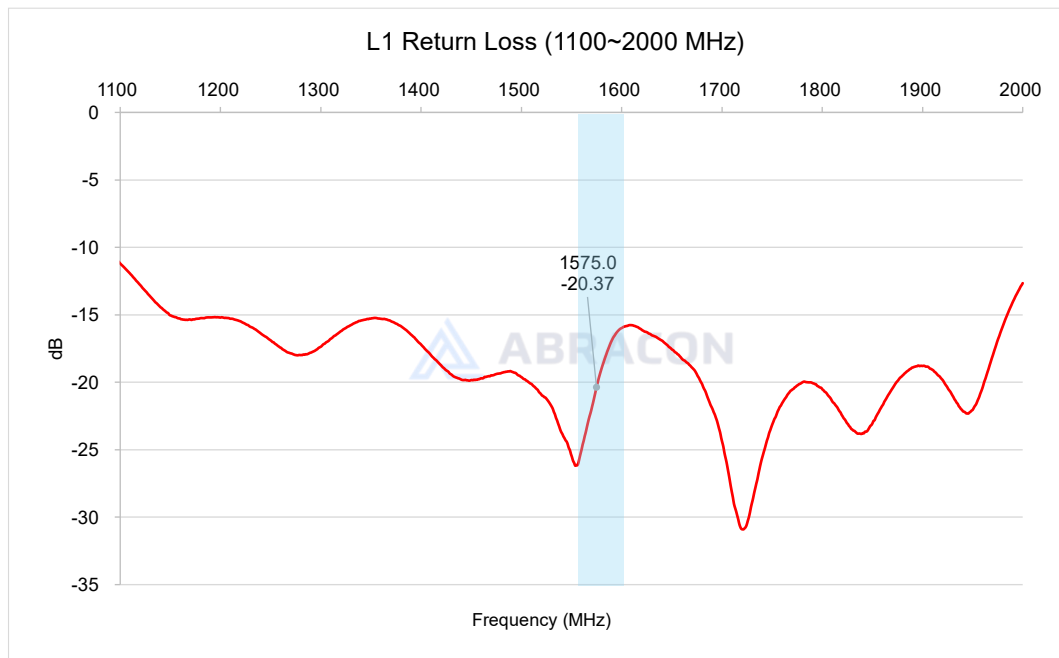
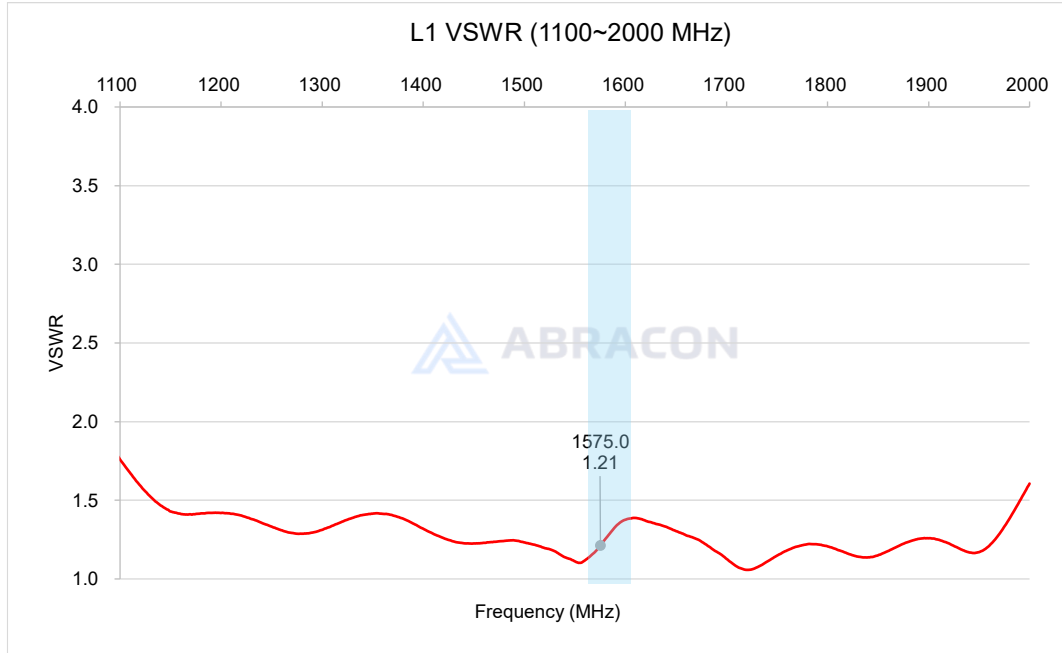

5101 Hidden Creek Ln Spicewood TX 78669
Phone: 512-371-6159 | Fax: 512-351-8858
For terms and conditions of sales, please visit:
www.abracon.com

REVISED: 04-26-23

ABRACON IS
ISO9001-2015
CERTIFIED

Active GNSS Dual-Band Stacked Patch Antenna

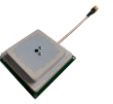

APKG5012GD

Request Samples



Check Inventory



50 x 50 x 12 mm

RoHS N/A

MSL Level = N/A

Measurement Setup

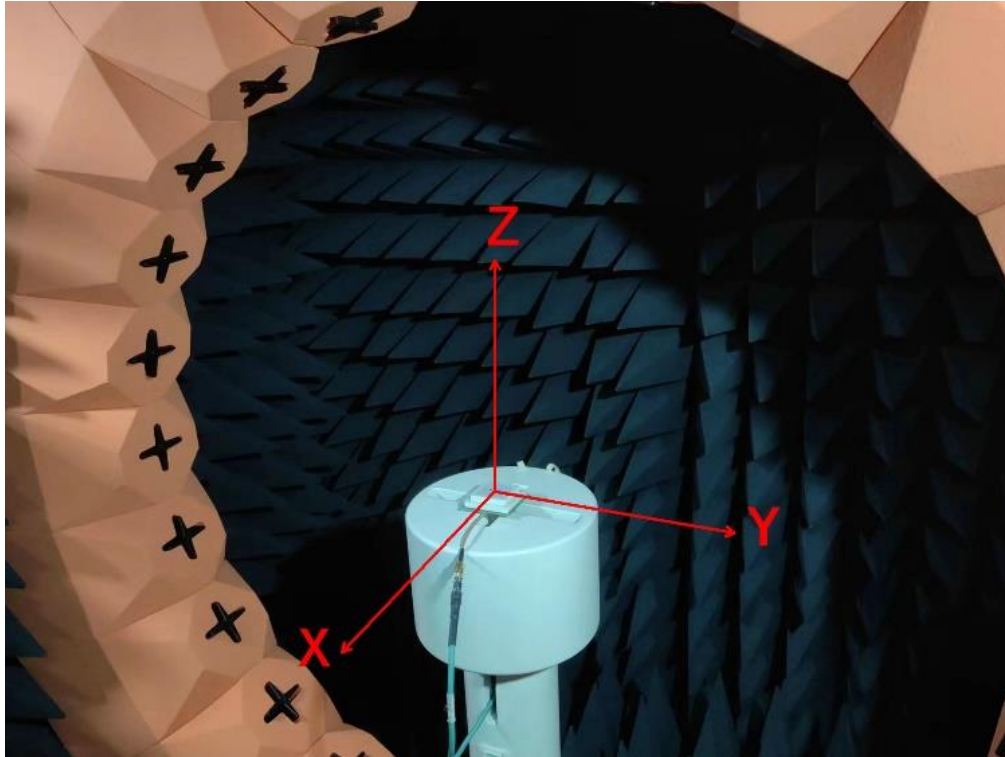

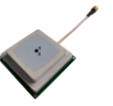

APKG5012GD

Request Samples



Check Inventory



50 x 50 x 12 mm
RoHS N/A
MSL Level = N/A

Radiation Characteristics –Passive Gain

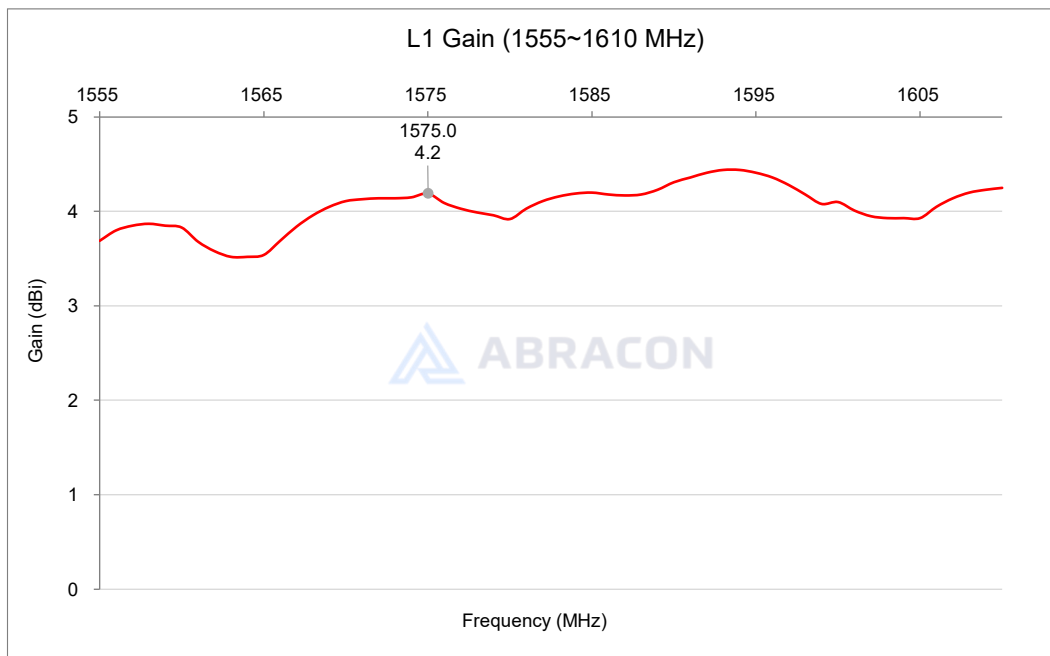
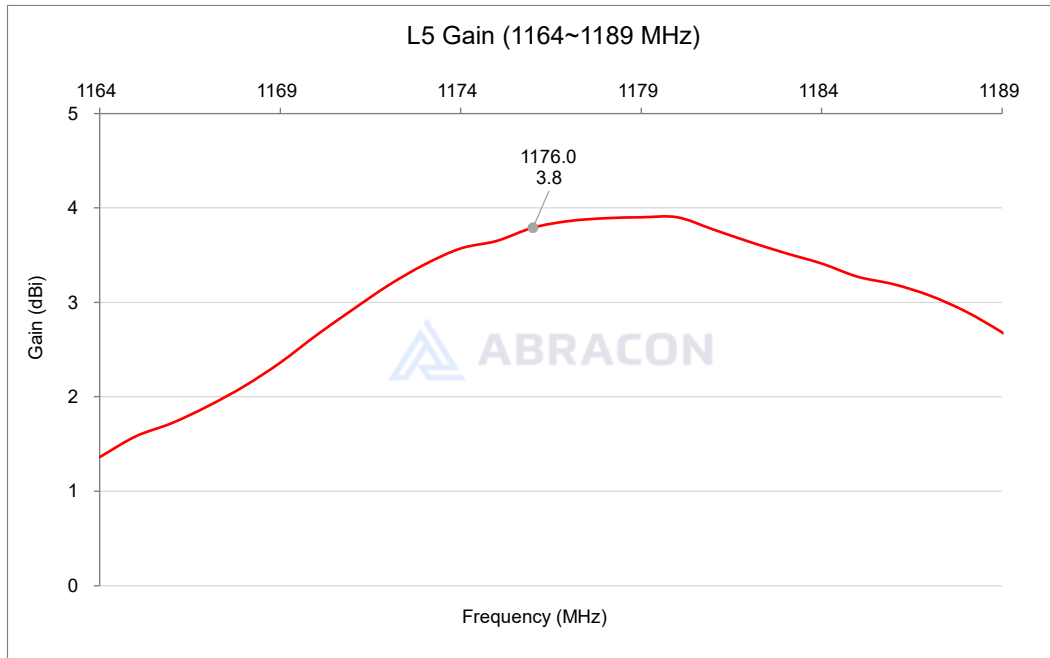

Active GNSS Dual-Band Stacked Patch Antenna

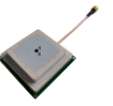

APKG5012GD

Request Samples



Check Inventory



50 x 50 x 12 mm

RoHS N/A

MSL Level = N/A

Radiation Characteristics – Total Efficiency (%)

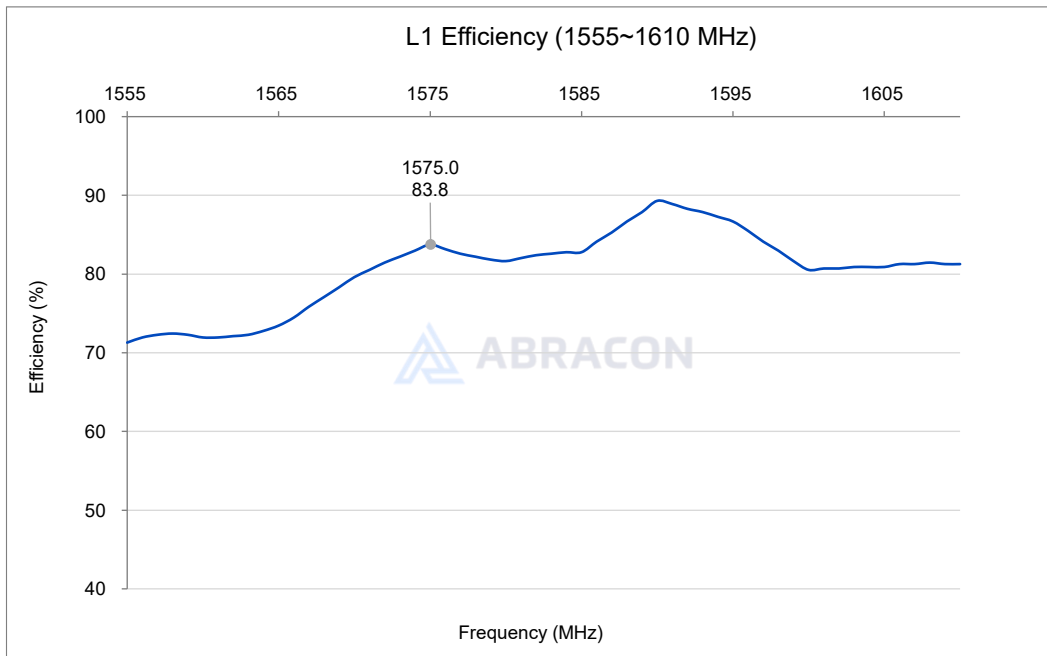
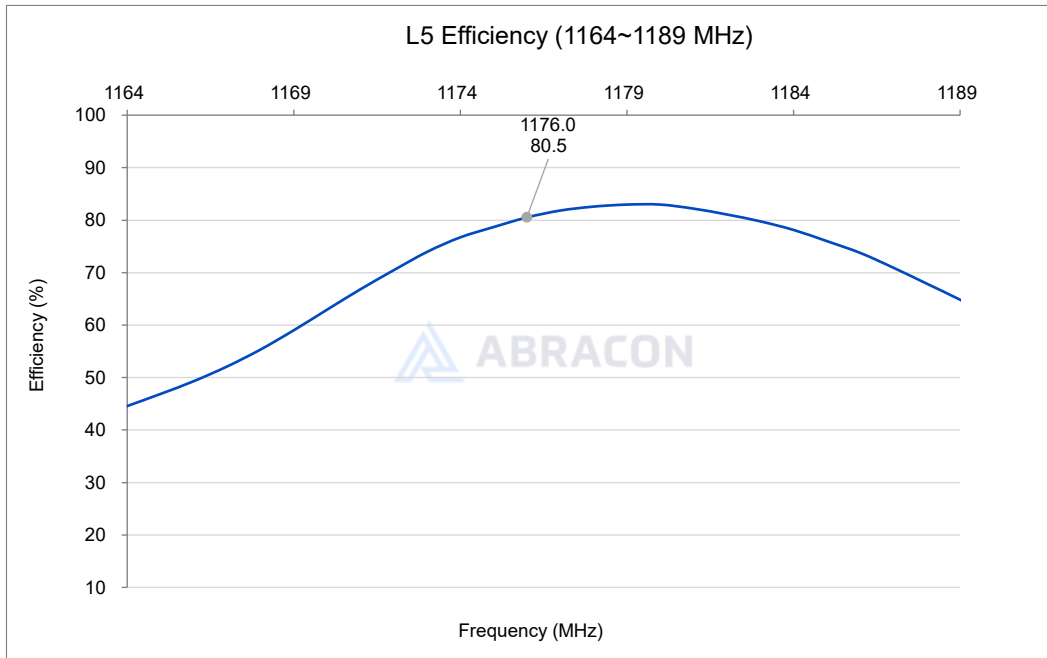

5101 Hidden Creek Ln Spicewood TX 78669
Phone: 512-371-6159 | Fax: 512-351-8858
For terms and conditions of sales, please visit:
www.abracon.com

REVISED: 04-26-23

ABRACON IS
ISO9001-2015
CERTIFIED

Active GNSS Dual-Band Stacked Patch Antenna

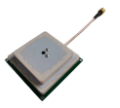

APKG5012GD

Request Samples



Check Inventory



50 x 50 x 12 mm

RoHS N/A

MSL Level = N/A

Radiation Characteristics –LNA Gain

Frequency, GHz	Gain, dB
1.176	39.299
1.561	38.389
1.575	39.970
1.602	39.395

Active GNSS Dual-Band Stacked Patch Antenna

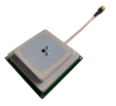

APKG5012GD

Request Samples



Check Inventory



50 x 50 x 12 mm

RoHS N/A

MSL Level = N/A

Radiation Characteristics – 3D & 2D Pattern

1176MHz

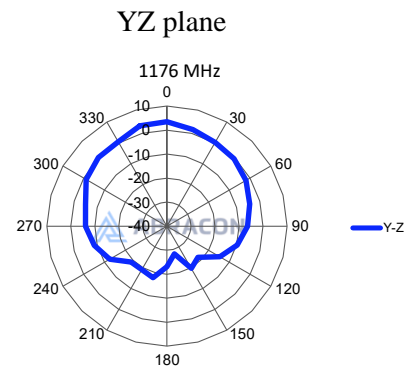
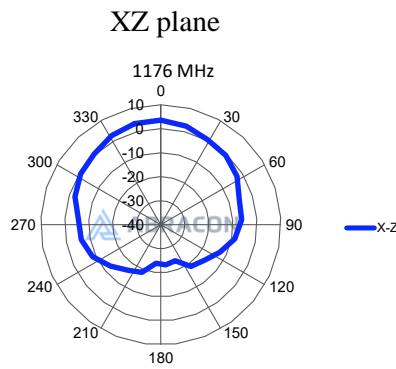
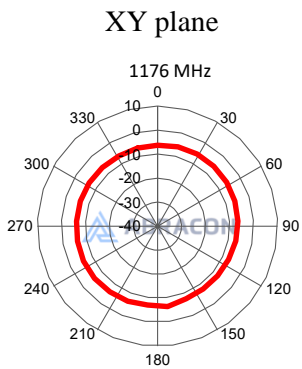
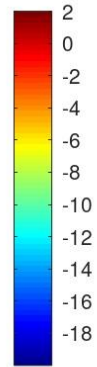
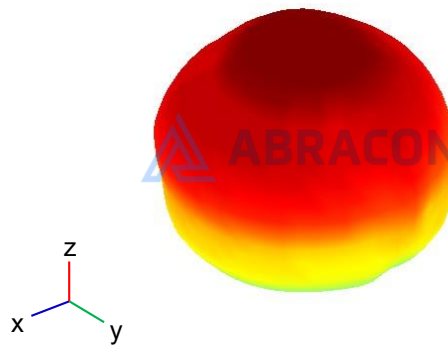
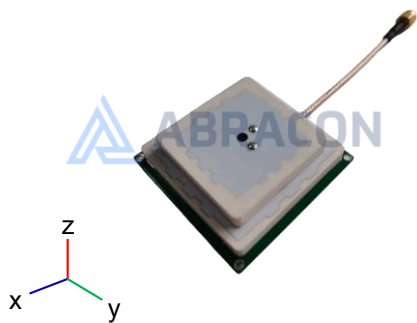

Active GNSS Dual-Band Stacked Patch Antenna

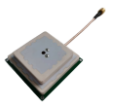

APKG5012GD

Request Samples



Check Inventory



50 x 50 x 12 mm
RoHS N/A
MSL Level = N/A

1575MHz

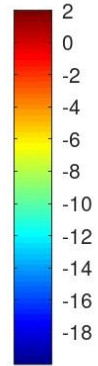
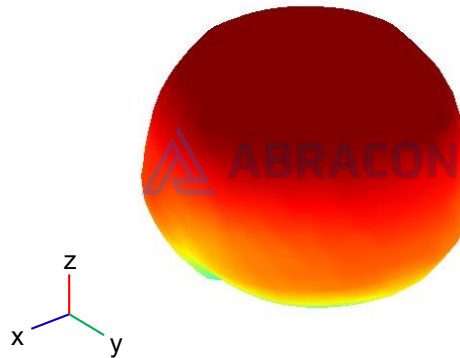
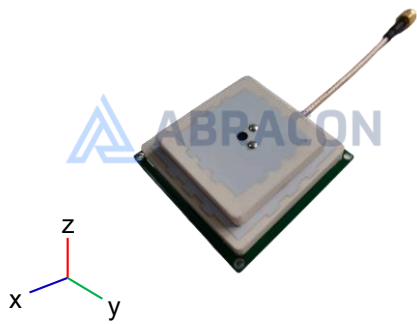

XY plane

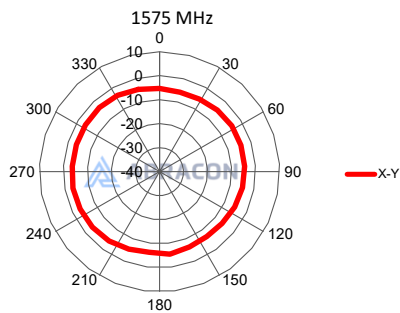

XZ plane

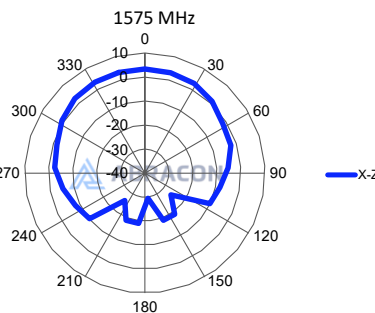

YZ plane

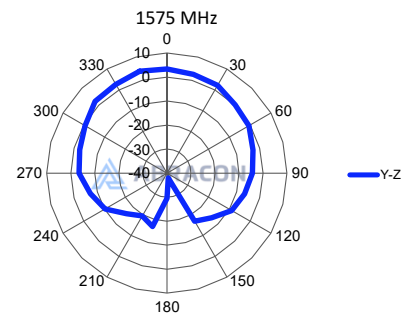

Active GNSS Dual-Band Stacked Patch Antenna

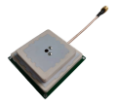

APKG5012GD

Request Samples



Check Inventory



50 x 50 x 12 mm

RoHS N/A

MSL Level = N/A

Packaging

8 pcs per package bases

Total 80 pcs antennas per outer box

Dimension of the outer box: 430 x 360 x 150 mm

ATTENTION: Abracon LLC's products are COTS – Commercial-Off-The-Shelf products; suitable for Commercial, Industrial and, where designated, Automotive Applications. Abracon's products are not specifically designed for Military, Aviation, Aerospace, Life-dependent Medical applications or any application requiring high reliability where component failure could result in loss of life and/or property. For applications requiring high reliability and/or presenting an extreme operating environment, written consent and authorization from Abracon LLC is required. Please contact Abracon LLC for more information.



5101 Hidden Creek Ln Spicewood TX 78669
Phone: 512-371-6159 | Fax: 512-351-8858
For terms and conditions of sales, please visit:
www.abracon.com

REVISED: 04-26-23

ABRACON IS
ISO9001-2015
CERTIFIED