

# SCHRACK FORCE GUIDED RELAYS SR6 NEXT GENERATION (SR6NG)

GENERAL PURPOSE RELAYS  
FORCE GUIDED RELAYS

## INTRODUCTION

TE Connectivity (TE)'s SR6nG is a fully compatible successor of TE's force guided relay series SR6A/B/C/V/D/M. With its force guided contacts the state of a contact can be monitored with a diagnostic coverage of 99% (IEC 61508-2) which makes the SR6nG ideal to design safety circuits. The Minimum contact load of 5V / 1mA allows direct monitoring through controller input. A more sensitive monostable magnetic coil system reduces heat generation. The relay height of 15.7mm fits best in 22.5mm DIN rail housings.

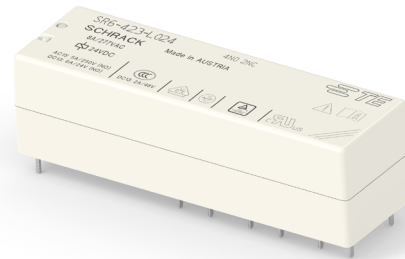

## FEATURES

- Monostable relay with 6 (4) force guided contacts acc. to IEC 61810-3
- Circuits of up to 400V can be connected. Contacts can switch up to 8A or 2200VA.
- Creepage and clearance distances allow reinforced isolation (IEC EN 62477) not just between coil and contacts but also between all contacts.
- 6 pole version with 3 different contact sets (3NO/3NC; 4NO/2NC; 5NO/1NC)
- Sensitive coil of 700mW allows use at 85°C under IEC 61810 conditions
- Special 4 pole version offers >15mm isolation between contacts and just 550mW coil power

## APPLICATIONS

- Safety Relay modules,
- Safety Controllers, PLC's
- Machines, Presses, Robots,
- Emergency shut-off, Light barriers
- Elevator and escalator safety control
- Railway Level crossings, Signaling

## APPROVALS

- VDE CERT. NO. 40055844
- TUV 968/FSP 2469.00/22
- UL E214025 VOL.9 SEC.6
- CCC 2022000303000046



# SR6 NEXT GENERATION

FORCE GUIDED RELAYS

## CONTACT DATA @ 25°C

Contact arrangement	3 form A(NO) + 3 form B(NC) 4 form A(NO) + 2 form B(NC) 5 form A(NO) + 1 form B(NC) 2 form A(NO) + 2 form B(NC) 3 form A(NO) + 1 form B(NC)
Rated voltage	277 V <sub>AC</sub>
Max. switching voltage	400 V <sub>AC</sub>
Rated current	8A
Total continuous current $I_{TH}^2 = I_1^2 + I_2^2 + I_3^2 \dots I_N^2$	131A <sup>2</sup>
Max. Breaking capacity AC	2200VA
Max. Breaking capacity DC	see DC Load breaking diagram
Contact material	AgSnO <sub>2</sub>
Contact style	Single contact, Force guided type A according to EN61810-3
Min. recommended contact load (reference)	5V <sub>DC</sub> , 1mA
Initial contact resistance	≤100mΩ at 1A, 24V <sub>DC</sub> ≤20Ω at 10mA, 5V <sub>DC</sub>
Frequency of operation, with/without load	6/150min <sup>-1</sup>

## COIL DATA

Coil voltage range	5 to 110VDC
Coil power 6-pole relays SR6-33x-Lxxx-xx; SR6-42x-Lxxx-xx; SR6-51x-Lxxx-xx	700mW
Coil power 4-pole relays SR6-22x-Uxxx-xx; SR6-31x-Uxxx-xx;	550mW
Operative range, IEC 61810	2
Coil insulation system according UL	Class F

## CONTACT RATINGS FOR SR6-II NEXT GEN

	Load	Cycles
<b>IEC61810-1</b>		
on 1 form A (NO) contact	8A, 250V <sub>AC</sub> resistive, 85°C	100x10 <sup>3</sup>
<b>IEC60947-5-1</b>		
on 1 form A (NO) contact	AC15 - 250V/5A	
on 1 form A (NO) contact	DC13 - 24V/6A	
<b>UL61810</b>		
on 1 form A (NO) contact	8A, 277V <sub>AC</sub> , general purpose, 85°C B300 R300	

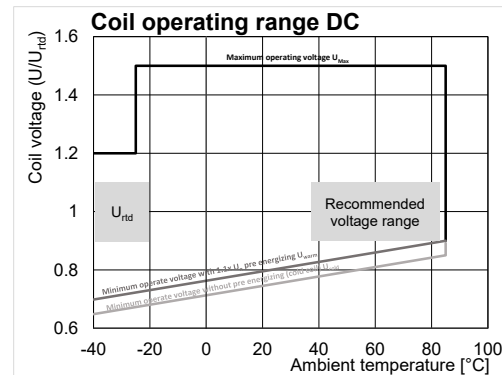
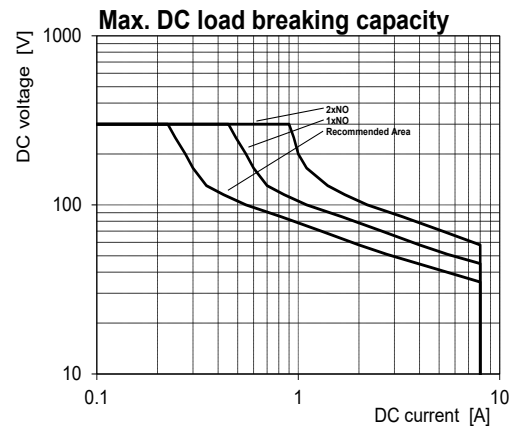

# SR6 NEXT GENERATION

FORCE GUIDED RELAYS

## LOW SENSITIVE L COIL VERSION (700mW), DC COIL 6-POLE RELAYS

Coil Code	Rated voltage $V_{DC}$	Operate voltage $V_{DC}$	Release voltage $V_{DC}$	Coil resistance $\Omega \pm 10\%$	Rated coil power mW
L005	5	3.5	0.5	26	700
L006	6	4.2	0.6	51	700
L009	9	6.3	0.9	115	700
L012	12	8.4	1.2	205	700
L015	15	10.5	1.5	321	700
L018	18	12.6	1.8	462	700
L021	21	14.7	2.1	630	700
L024	24	16.8	2.4	822	700
L030	30	21	3	1285	700
L036	36	25.2	3.6	1851	700
L040	40	28	4	2285	700
L048	48	33.6	4.8	3291	700
L060	60	42	6	5142	700
L085	85	59.5	8.5	10321	700
L110	110	77	11	17286	700

## ULTRA LOW SENSITIVE U COIL VERSION (550mW), DC COIL 4-POLE RELAYS

Coil Code	Rated voltage $V_{DC}$	Operate voltage $V_{DC}$	Release voltage $V_{DC}$	Coil resistance $\Omega \pm 10\%$	Rated coil power mW
U005	5	3.5	0.5	45	550
U006	6	4.2	0.6	65	550
U009	9	6.3	0.9	147	550
U012	12	8.4	1.2	262	550
U015	15	10.5	1.5	409	550
U018	18	12.6	1.8	589	550
U021	21	14.7	2.1	802	550
U024	24	16.8	2.4	1047	550
U030	30	21	3	1636	550
U036	36	25.2	3.6	2356	550
U040	40	28	4	2909	550
U048	48	33.6	4.8	4189	550
U060	60	42	6	6546	550
U085	85	59.5	8.5	13136	550
U110	110	77	11	22000	550

All figures are given for coil without pre-energization, at ambient temperature +23°C.

Characteristically electrical endurance acc. IEC60947-5-1 AC-15 Ue=250VAC 23°C

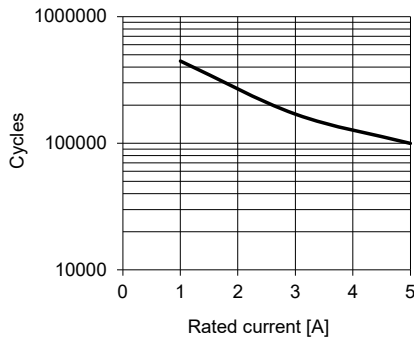

Characteristically electrical endurance acc. IEC60947-5-1 DC-13 Ue=24VDC 23°C

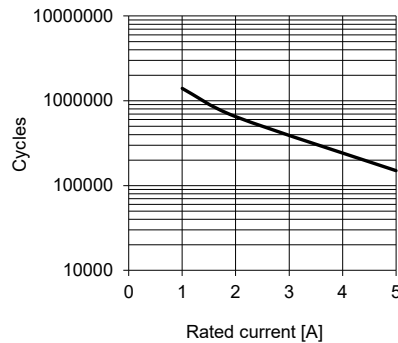

Characteristically electrical endurance acc. IEC60947-5-1 DC-1 Ue=24VDC

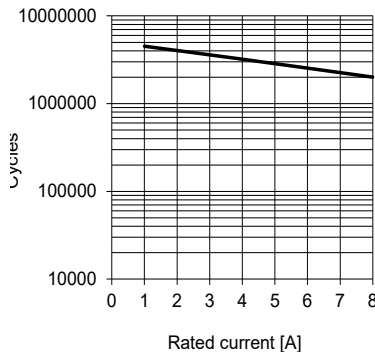

Characteristically electrical endurance acc. IEC60947-5-1 AC-1 Ue=250VAC 85°C

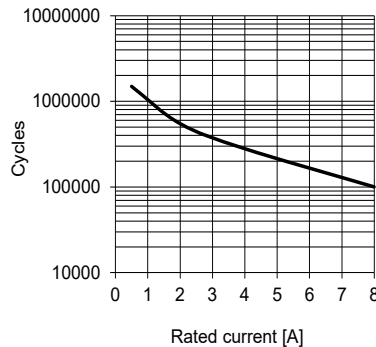

# SR6 NEXT GENERATION

FORCE GUIDED RELAYS

## INSULATION DATA

Initial dielectric strength	
between open contacts	1500V <sub>rms</sub>
between contact and coil	4000V <sub>rms</sub>
between adjacent contacts	3000V <sub>rms</sub>
4-pole types:	
between adjacent contacts longitudinal direction	4000V <sub>rms</sub>
Initial surge withstand voltage	
between contact and coil	6000V <sub>rms</sub>
Clearance/creepage	
between open contacts	microdisconnections
between contact and coil	≥5.56mm
between adjacent contacts	≥5.56mm
4-pole types:	
between adjacent contacts longitudinal direction	≥15mm
Insulation to IEC EN 62477 (former EN 50178), type of insulation	
between contact and coil	reinforced
between adjacent contacts	reinforced

## OTHER DATA

Material compliance	EU RoHS/ELV, China RoHS, REACH, Halogen content refer to the Product Compliance Support Center at <a href="http://www.te.com/customer-support/rohssupportcenter">www.te.com/customer-support/rohssupportcenter</a>
Ambient temperature	-40 to 85°C
Category of environmental protection	
IEC 61810	RTIII - wash tight
Weight	approx. 29.5g
Vibration resistance (functional) 30 - 500Hz	
IEC 60068-2-6 (half sine) NO closing	min. 10g, 10 s
IEC 60068-2-6 (half sine) NO opening	min. 20g, 10 s
IEC 60068-2-6 (half sine) NC opening	min. 2g, 10 s
IEC 60068-2-6 (half sine) NC closing	min. 3g, 10 s
Shock resistance (functional)	
IEC 60068-2-27 (half sine) NO	min. 20g, 11ms
IEC 60068-2-27 (half sine) NC	min. 2g, 11ms
Shock resistance (destructive)	min. 100g, 11ms
Terminal type	PCB-THT
Resistance to soldering heat THT	
IEC 60068-2-20	260°C/5s
Packaging/unit	tube/10 pcs.

## OUTLINE DIMENSIONS

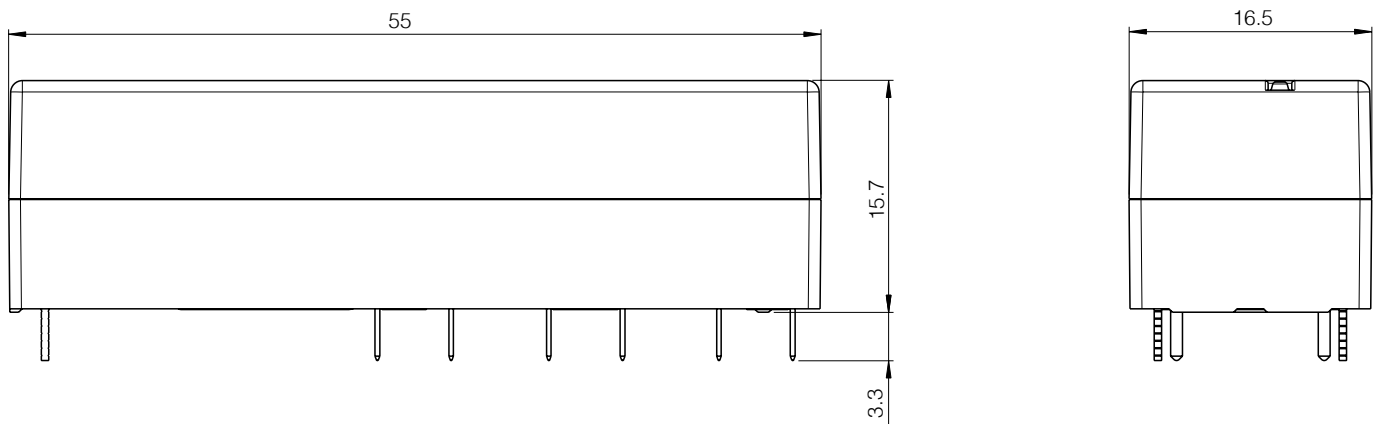

# SR6 NEXT GENERATION

FORCE GUIDED RELAYS

## OUTLINE DIMENSIONS

3 form A + 3 form B, 3 NO + 3 NC versions  
SR6

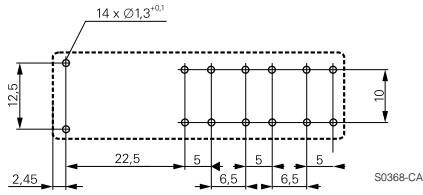

S0368-CA

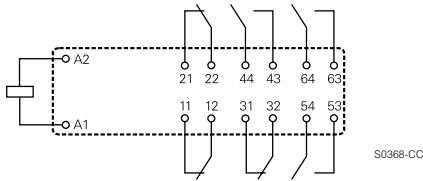

S0368-CC

4 form A + 2 form B, 4 NO + 2 NC versions  
SR6

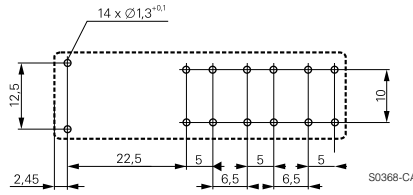

S0368-CA

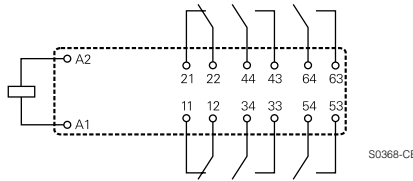

S0368-CB

5 form A + 1 form B, 5 NO + 1 NC versions  
SR6

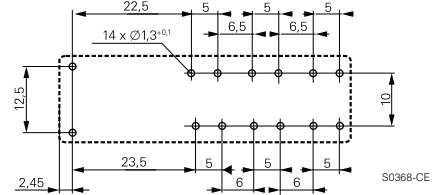

S0368-CE

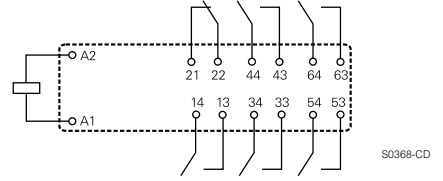

S0368-CD

4 form A + 2 form B, 4 NO + 2 NC versions SR6

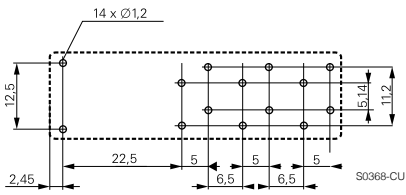

S0368-CU

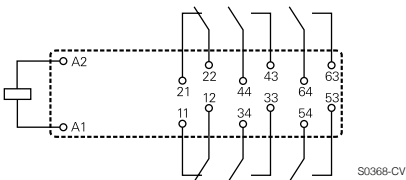

S0368-CV

2 form A + 2 form B, 2 NO + 2 NC versions

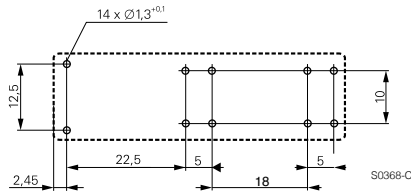

S0368-CI

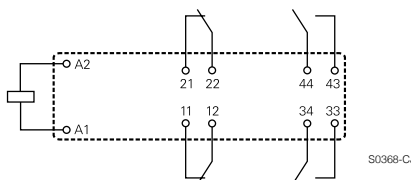

S0368-CJ

3 form A + 1 form B, 3 NO + 1 NC contacts

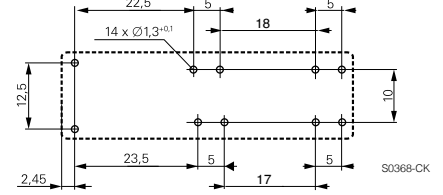

S0368-CK

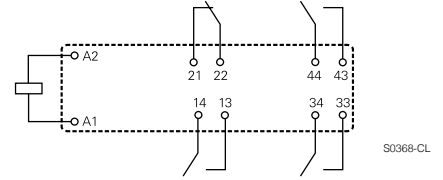

S0368-CL

The design of the SR6 Next Gen with crossed pin layout allows clearance/creepage of 5.56 mm on the PCB.

# SR6 NEXT GENERATION

FORCE GUIDED RELAYS

## PRODUCT CODE STRUCTURE

**Part Number**  
**SR 6 -4 2 3 -L 005 -0 0 0 #####**

### Type

<b>SR6</b>	Relay with force guided contacts
------------	----------------------------------

### Version

<b>6</b>	6 pole
----------	--------

### Number of NO contact configurations

<b>5</b>	5 form A, NO sets
<b>4</b>	4 form A, NO sets
<b>3</b>	3 form A, NO sets
<b>2</b>	2 form A, NO sets (4-pole types only)

### Number of NC contact configurations

<b>1</b>	1 form B, NC sets
<b>2</b>	2 form B, NC sets
<b>3</b>	3 form B, NC sets

### Contact Material

<b>3</b>	AgSnO <sub>2</sub>
<b>6</b>	AgSnO <sub>2</sub> + Au flush

### Coil version

<b>L</b>	DC 700mW coil power (6-pole types only)
<b>U</b>	DC 550mW coil power (4-pole types only)

### Additional manufacturer indications

<b>####</b>	May be followed by up to 4 numbers and/or letters only for manufacturer internal identification
-------------	---

### Mechanical features (Pin length)

<b>0</b>	Standard (3,3mm)
<b>1</b>	Short pin (2,5mm)

### Electrical Features (Terminal alignment)

<b>O</b>	Standard pin layout
<b>V</b>	Crossed pin layout

### Category of protection

<b>0</b>	RTIII Wash tight
----------	------------------

### Coil

Coil voltage code: please refer to coil versions table (e.g. 005=5VDC)	
--	--

# SR6 NEXT GENERATION

FORCE GUIDED RELAYS

## PRODUCT INFORMATION

Product code	Type	Contact arrangement	Contact material	Coil	Coil power	Part number
SR6-333-L005-00	6-pole relay with force guided contacts	3 form A + 3 form B, 3NO + 3NC contacts	AgSnO2	5VDC	700mW	1558736-1
SR6-333-L012-00				12VDC		1558736-4
SR6-333-L021-00				21VDC		1558736-7
SR6-333-L024-00				24VDC		1558736-8
SR6-333-L048-00				48VDC		1-1558736-2
SR6-333-L060-00				60VDC		1-1558736-3
SR6-333-L110-00				110VDC		1-1558736-5
SR6-336-L005-00			AgSnO2 + Au	5VDC		2-1558736-1
SR6-336-L012-00				12VDC		2-1558736-4
SR6-336-L018-00				18VDC		2-1558736-6
SR6-336-L021-00				21VDC		2-1558736-7
SR6-336-L024-00				24VDC		2-1558736-8
SR6-336-L110-00				110VDC		3-1558736-5
SR6-423-L005-00				4 form A + 2 form B, 4NO + 2NC contacts		AgSnO2
SR6-423-L006-00		6VDC	1558737-2			
SR6-423-L012-00		12VDC	1558737-4			
SR6-423-L018-00		18VDC	1558737-6			
SR6-423-L021-00		21VDC	1558737-7			
SR6-423-L024-00		24VDC	1558737-8			
SR6-423-L040-00		40VDC	1-1558737-1			
SR6-423-L048-00		48VDC	1-1558737-2			
SR6-423-L060-00		60VDC	1-1558737-3			
SR6-423-L085-00		85VDC	1-1558737-4			
SR6-423-L110-00		110VDC	1-1558737-5			
SR6-426-L012-00		AgSnO2 + Au	12VDC		2-1558737-4	
SR6-426-L015-00			15VDC		2-1558737-5	
SR6-426-L018-00	18VDC		2-1558737-6			
SR6-426-L021-00	21VDC		2-1558737-7			
SR6-426-L024-00	24VDC		2-1558737-8			
SR6-513-L012-00	5 form A + 1 form B, 5NO + 1NC contacts		AgSnO2		12VDC	1558738-4
SR6-513-L018-00					18VDC	1558738-6
SR6-513-L024-00		24VDC		1558738-8		
SR6-513-L048-00		48VDC		1-1558738-2		
SR6-513-L060-00		60VDC		1-1558738-3		
SR6-513-L110-00		110VDC	1-1558738-5			
SR6-516-L012-00		AgSnO2 + Au	12VDC	2-1558738-4		
SR6-516-L024-00			24VDC	2-1558738-8		

Note. This list represents the most common types and does not show all variants covered by this datasheet. Other types on request.

**PRODUCT INFORMATION CONTINUED..**

Product code	Type	Contact arrangement	Contact material	Coil	Coil power	Part number
SR6-426-L012-0V		4 form A + 2 form B, 4NO + 2NC contacts (crossed pin layout)	AgSnO2 + Au	12VDC	700mW	2-1558739-4
SR6-426-L015-0V				15VDC		2-1558739-5
SR6-426-L018-0V				18VDC		2-1558739-6
SR6-426-L021-0V				21VDC		2-1558739-7
SR6-426-L024-0V				24VDC		2-1558739-8
SR6-426-L040-0V				40VDC		3-1558739-1
SR6-426-L110-0V				110VDC		3-1558739-5
SR6-223-U012-00	4-pole relay with force guided contacts	2 form A + 2 form B, 2NO + 2NC contacts	AgSnO2	12VDC	550mW	1558740-4
SR6-223-U018-00				18VDC		1558740-6
SR6-223-U021-00				21VDC		1558740-7
SR6-223-U024-00				24VDC		1558740-8
SR6-223-U040-00				40VDC		1-1558740-1
SR6-223-U110-00				110VDC		1-1558740-5
SR6-313-U006-00		3 form A + 1 form B, 3NO + 1NC contacts		6VDC		1558741-2
SR6-313-U012-00				12VDC		1558741-4
SR6-313-U018-00				18VDC		1558741-6
SR6-313-U021-00				21VDC		1558741-7
SR6-313-U024-00				24VDC		1558741-8
SR6-313-U048-00				48VDC		1-1558741-2
SR6-313-U110-00				110VDC		1-1558741-5

Note. This list represents the most common types and does not show all variants covered by this datasheet. Other types on request.

**Notes:**

1. Datasheets and product specification according to IEC 61810-1 and to be used only together with the 'Definitions' section.
2. Datasheets and product data is subject to the terms of the disclaimer and all chapters of the 'Definitions' section, available at <http://relays.te.com/definitions>.
3. Datasheets, product data, 'Definitions' section, application notes and all specifications are subject to change.

**te.com**

©2023 TE Connectivity. All Rights Reserved.

TE Connectivity, TE connectivity (logo) and Every Connection Counts are trademarks. All other logos, products and/or company names referred to herein might be trademarks of their respective owners.

The information given herein, including drawings, illustrations and schematics which are intended for illustration purposes only, is believed to be reliable. However, TE Connectivity makes no warranties as to its accuracy or completeness and disclaims any liability in connection with its use. TE Connectivity's obligations shall only be as set forth in TE Connectivity's Standard Terms and Conditions of Sale for this product and in no case will TE Connectivity be liable for any incidental, indirect or consequential damages arising out of the sale, resale, use or misuse of the product. Users of TE Connectivity products should make their own evaluation to determine the suitability of each such product for the specific application.

03/23 ED

