

## MOSFET

### 600V CoolMOS™ SJ S7 Power Device

IPT60T022S7 enables the best price performance for low-frequency switching applications. CoolMOS™ S7 boasts the lowest  $R_{DS(on)}$  values for an HV SJ MOSFET, with a distinctive increase in energy efficiency. The embedded Temperature sensor increases junction temperature sensing accuracy and robustness while keeping an easy and seamless implementation. CoolMOS™ S7 is optimized for “static switching” and high current applications. It is an ideal fit for solid-state relay, circuit breaker designs, and line rectification in SMPS and inverter topologies. The new temperature sensor enhances S7 features, allowing the best possible utilization of the power transistor.

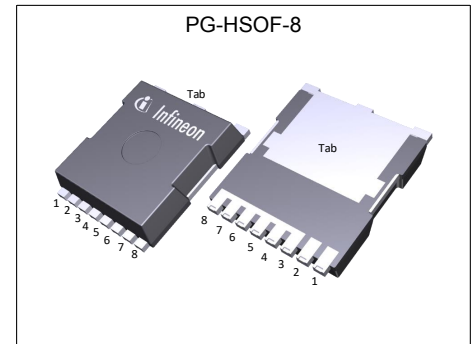

### Features

- CoolMOS™ S7 technology enables lowest  $R_{DS(on)}$  in the smallest footprint
- Optimized price performance in low-frequency switching applications
- High pulse current capability
- Seamless diagnostics at the lowest system
- Temperature sense feature for protection and optimized thermal device utilization cost

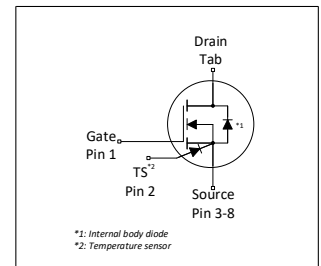

### Benefits

- Minimized conduction losses (eliminate/reduce heat sink)
- Increased system performance
- More compact and more straightforward design
- Lower BOM or/and TCO over a prolonged lifetime
- Reduction of external sensing elements

#### Compared to electromechanical devices:

- Faster switching times
- More reliability and longer system lifetime
- Shock & Vibration resistance
- No contact arcing or bouncing



### Potential applications

- Solid state relays and circuit breakers
- Line rectification in high power/performance applications e.g. Computing, Telecom, UPS and Solar

### Product validation

Fully qualified according to JEDEC for Industrial Applications

**Table 1 Key Performance Parameters**

Parameter	Value	Unit
$R_{DS(on),max}$	22	mΩ
$Q_{g,typ}$	150	nC
$V_{SD}$	0.82	V
Pulsed $I_{SD}, I_{DS}$	371	A
ESD class (HBM)	2	JEDEC JS-001

Type / Ordering Code	Package	Marking	Related Links
IPT60T022S7	PG-HSOF-8	60I022S7	see Appendix A

## Table of Contents

Description .....	1
Maximum ratings .....	3
Thermal characteristics .....	4
Electrical characteristics .....	5
Temperature Sensor parameters .....	7
Electrical characteristics diagrams .....	8
Test Circuits .....	13
Package Outlines .....	14
Appendix A .....	15
Revision History .....	16
Trademarks .....	16
Disclaimer .....	16

## 1 Maximum ratings

at  $T_j = 25^\circ\text{C}$ , unless otherwise specified

**Table 2 Maximum MOSFET ratings**

Parameter	Symbol	Values			Unit	Note / Test Condition
		Min.	Typ.	Max.		
Drain current rating <sup>1)</sup>	$I_D$	-	-	23	A	$T_C=25^\circ\text{C}$ Current is limited by $T_{j\text{max}} = 150^\circ\text{C}$
Pulsed drain current <sup>2)</sup>	$I_{D,\text{pulse}}$	-	-	371	A	$T_C=25^\circ\text{C}$
Avalanche energy, single pulse	$E_{AS}$	-	-	286	mJ	$I_D=3.7\text{A}$ ; $V_{DD}=50\text{V}$ ; see table 11
Avalanche current, single pulse	$I_{AS}$	-	-	3.7	A	-
MOSFET dv/dt ruggedness <sup>3)</sup>	dv/dt	-	-	20	V/ns	$V_{DS}= 0\text{V to } 300\text{V}$
Gate source voltage (static)	$V_{GS}$	-20	-	20	V	static
Gate source voltage (dynamic)	$V_{GS}$	-30	-	30	V	AC ( $f>1\text{ Hz}$ )
Power dissipation	$P_{\text{tot}}$	-	-	390	W	$T_C=25^\circ\text{C}$
Storage temperature	$T_{\text{stg}}$	-55	-	150	$^\circ\text{C}$	-
Operating junction temperature <sup>1)</sup>	$T_j$	-55	-	150	$^\circ\text{C}$	-
Extended operating junction temperature	$T_j$	150	-	175	$^\circ\text{C}$	$\leq 50\text{ h}$ in the application lifetime
Mounting torque	-	-	-	n.a.	Ncm	-
Diode forward current rating	$I_S$	-	-	23	A	$T_C=25^\circ\text{C}$ Current is limited by $T_{j\text{max}} = 150^\circ\text{C}$
Diode pulse current <sup>1)</sup>	$I_{S,\text{pulse}}$	-	-	371	A	$T_C=25^\circ\text{C}$
Reverse diode dv/dt <sup>4)</sup>	dv/dt	-	-	5	V/ns	$V_{DS}=0\text{ to } 300\text{V}$ , $I_{SD}\leq 23\text{A}$ , $T_j=25^\circ\text{C}$ see table 9
Maximum diode commutation speed	di <sub>i</sub> /dt	-	-	800	A/ $\mu\text{s}$	$V_{DS}=0\text{ to } 300\text{V}$ , $I_{SD}\leq 23\text{A}$ , $T_j=25^\circ\text{C}$ see table 9
Insulation withstand voltage	$V_{\text{ISO}}$	-	-	n.a.	V	-

<sup>1)</sup> Please consider the App Note: AN\_2308\_PL52\_2309\_111546 for high delta  $T_j$  usage

<sup>2)</sup> Pulse width  $t_p$  limited by  $T_{j\text{max}}$

<sup>3)</sup> The dv/dt has to be limited by appropriate gate resistor

<sup>4)</sup> Identical low side and high side switch

## 2 Thermal characteristics

**Table 3 Thermal characteristics**

Parameter	Symbol	Values			Unit	Note / Test Condition
		Min.	Typ.	Max.		
Thermal resistance, junction - case	$R_{thJC}$	-	-	0.32	°C/W	-
Thermal resistance, junction - ambient	$R_{thJA}$	-	-	62	°C/W	device on PCB, minimal footprint
Thermal resistance, junction - ambient for SMD version	$R_{thJA}$	-	35	45	°C/W	Device on 40mm*40mm*1.5mm epoxy PCB FR4 with 6cm <sup>2</sup> (one layer, 70µm thickness) copper area for drain connection and cooling. PCB is vertical without air stream cooling.
Soldering temperature, wave- & reflow soldering allowed	$T_{sold}$	-	-	260	°C	reflow MSL1

### 3 Electrical characteristics

at  $T_j=25^\circ\text{C}$ , unless otherwise specified

**Table 4 Static characteristics**

For applications with applied blocking voltage >420V, it is required that the customer evaluates the impact of cosmic radiation effect in early design phase and contacts the Infineon sales office for the necessary technical support by Infineon

Parameter	Symbol	Values			Unit	Note / Test Condition
		Min.	Typ.	Max.		
Drain-source breakdown voltage	$V_{(BR)DSS}$	600	-	-	V	$V_{GS}=0V, I_D=1mA$
Gate threshold voltage	$V_{(GS)th}$	3.5	4.0	4.5	V	$V_{DS}=V_{GS}, I_D=1.43mA$
Zero gate voltage drain current <sup>1)</sup>	$I_{DSS}$	-	-	5	$\mu A$	$V_{DS}=600V, V_{GS}=0V, T_j=25^\circ C$ $V_{DS}=600V, V_{GS}=0V, T_j=150^\circ C$
Gate-source leakage current	$I_{GSS}$	-	-	100	nA	$V_{GS}=20V, V_{DS}=0V$
Drain-source on-state resistance	$R_{DS(on)}$	-	0.02	0.022	$\Omega$	$V_{GS}=12V, I_D=23.0A, T_j=25^\circ C$ $V_{GS}=12V, I_D=23.0A, T_j=150^\circ C$
Gate resistance	$R_G$	-	0.8	-	$\Omega$	$f=1MHz, \text{open drain}$

**Table 5 Dynamic characteristics**

Parameter	Symbol	Values			Unit	Note / Test Condition
		Min.	Typ.	Max.		
Input capacitance	$C_{iss}$	-	5640	-	pF	$V_{GS}=0V, V_{DS}=300V, f=250kHz$
Output capacitance	$C_{oss}$	-	89	-	pF	$V_{GS}=0V, V_{DS}=300V, f=250kHz$
Effective output capacitance, energy related <sup>2)</sup>	$C_{o(er)}$	-	303	-	pF	$V_{GS}=0V, V_{DS}=0 \text{ to } 300V$
Effective output capacitance, time related <sup>3)</sup>	$C_{o(tr)}$	-	2678	-	pF	$I_D=\text{constant}, V_{GS}=0V, V_{DS}=0 \text{ to } 300V$
Output charge	$Q_{oss}$	-	803	-	nC	$V_{GS}=0V, V_{DS}=0 \text{ to } 300V$
Turn-on delay time	$t_{d(on)}$	-	23	-	ns	$V_{DD}=300V, V_{GS}=13V, I_D=23.0A, R_G=5.3\Omega; \text{ see table 9}$
Rise time	$t_r$	-	15	-	ns	$V_{DD}=300V, V_{GS}=13V, I_D=23.0A, R_G=5.3\Omega; \text{ see table 9}$
Turn-off delay time	$t_{d(off)}$	-	150	-	ns	$V_{DD}=300V, V_{GS}=13V, I_D=23.0A, R_G=5.3\Omega; \text{ see table 9}$
Fall time	$t_f$	-	9	-	ns	$V_{DD}=300V, V_{GS}=13V, I_D=23.0A, R_G=5.3\Omega; \text{ see table 9}$

<sup>1)</sup> Open

<sup>2)</sup>  $C_{o(er)}$  is a fixed capacitance that gives the same stored energy as  $C_{oss}$  while  $V_{DS}$  is rising from 0 to 300V

<sup>3)</sup>  $C_{o(tr)}$  is a fixed capacitance that gives the same charging time as  $C_{oss}$  while  $V_{DS}$  is rising from 0 to 300V

**Table 6 Gate charge characteristics**

Parameter	Symbol	Values			Unit	Note / Test Condition
		Min.	Typ.	Max.		
Gate to source charge	$Q_{gs}$	-	31	-	nC	$V_{DD}=300V, I_D=23.0A, V_{GS}=0$ to 12V
Gate to drain charge	$Q_{gd}$	-	50	-	nC	$V_{DD}=300V, I_D=23.0A, V_{GS}=0$ to 12V
Gate charge total	$Q_g$	-	150	-	nC	$V_{DD}=300V, I_D=23.0A, V_{GS}=0$ to 12V
Gate plateau voltage	$V_{plateau}$	-	5.4	-	V	$V_{DD}=300V, I_D=23.0A, V_{GS}=0$ to 12V

**Table 7 Reverse diode characteristics**

Parameter	Symbol	Values			Unit	Note / Test Condition
		Min.	Typ.	Max.		
Diode forward voltage	$V_{SD}$	-	0.82	-	V	$V_{GS}=0V, I_F=23.0A, T_j=25^\circ C$
Reverse recovery time	$t_{rr}$	-	460	-	ns	$V_R=400V, I_F=23.0A, di_F/dt=100A/\mu s$ ; see table 8
Reverse recovery charge	$Q_{rr}$	-	9.00	-	$\mu C$	$V_R=400V, I_F=23.0A, di_F/dt=100A/\mu s$ ; see table 8
Peak reverse recovery current	$I_{rrm}$	-	40.0	-	A	$V_R=400V, I_F=23.0A, di_F/dt=100A/\mu s$ ; see table 8

## 4 Temperature Sensor parameters

at  $T_j=25^\circ\text{C}$ , unless otherwise specified

**Table 8 Maximum ratings**

Parameter	Symbol	Values			Unit	Note / Test Condition
		Min.	Typ.	Max.		
Repetitive Peak Reverse Voltage	$V_{RRM}$	-	-	15	V	$I_R = 100 \mu\text{A}$
Sensor forward current	$I_F$	-	-	5	mA	-
Repetitive peak forward current	$I_{F\_pulse}$	-	-	25	mA	$t_{pulse} = 1 \text{ ms}$ , $T_{period} = 10 \text{ ms}$
Non-repetitive peak forward current	$I_{FSM}$	-	-	1.5 0.2 0.1	A	$T_C = 25^\circ\text{C}$ , $t_{pulse} = 1 \mu\text{s}$ $T_C = 25^\circ\text{C}$ , $t_{pulse} = 1 \text{ ms}$ $T_C = 25^\circ\text{C}$ , $t_{pulse} = 1 \text{ s}$
Junction Temperature	$T_j$	-	-	185	$^\circ\text{C}$	$t < 50\text{h}$ , Sensor only

**Table 9 Electrical characteristics**

Parameter	Symbol	Values			Unit	Note / Test Condition
		Min.	Typ.	Max.		
Sensor forward voltage <sup>1)</sup>	$V_{F\_25}$	1.5601 - - 2.0665	1.6019 1.8103 1.9806 2.0966	1.6436 - - 2.1266	V	$T_j = 25^\circ\text{C}$ , $I_F = 10 \mu\text{A}$ $T_j = 25^\circ\text{C}$ , $I_F = 50 \mu\text{A}$ $T_j = 25^\circ\text{C}$ , $I_F = 200 \mu\text{A}$ $T_j = 25^\circ\text{C}$ , $I_F = 500 \mu\text{A}$
Sensor forward voltage temperature coefficient	$TC$	- - - -	5.9644 5.5880 5.2287 5.0135	- - - -	mV/K	$25^\circ\text{C} \leq T_j \leq 175^\circ\text{C}$ , $I_F = 10 \mu\text{A}$ $25^\circ\text{C} \leq T_j \leq 175^\circ\text{C}$ , $I_F = 50 \mu\text{A}$ $25^\circ\text{C} \leq T_j \leq 175^\circ\text{C}$ , $I_F = 200 \mu\text{A}$ $25^\circ\text{C} \leq T_j \leq 175^\circ\text{C}$ , $I_F = 500 \mu\text{A}$
Sensor forward voltage	$V_{F\_175}$	0.6655 - - 1.3144	0.7072 0.9721 1.1963 1.3445	0.7490 - - 1.3746	V	$T_j = 175^\circ\text{C}$ , $I_F = 10 \mu\text{A}$ $T_j = 175^\circ\text{C}$ , $I_F = 50 \mu\text{A}$ $T_j = 175^\circ\text{C}$ , $I_F = 200 \mu\text{A}$ $T_j = 175^\circ\text{C}$ , $I_F = 500 \mu\text{A}$
Reverse leakage current	$I_R$	- -	- -	1 20	$\mu\text{A}$	$V_R = 10\text{V}$ , $T_j = 25^\circ\text{C}$ $V_R = 10\text{V}$ , $T_j = 175^\circ\text{C}$
Sensor G Capacitance	$C_{GTS}$	-	4.2	-	pF	$f = 1 \text{ MHz}$ , $I_F = 50 \mu\text{A}$
Sensor Capacitance	$C_{STS}$	-	4.8	-	pF	$f = 1 \text{ MHz}$ , $I_F = 50 \mu\text{A}$
Anode-Drain Capacitance	$C_{DTS}$	-	0.5	-	pF	$f = 1 \text{ MHz}$ , $V_{DS} = 0 \text{ V}$

<sup>1)</sup> Specified by Design and not tested

## 5 Electrical characteristics diagrams

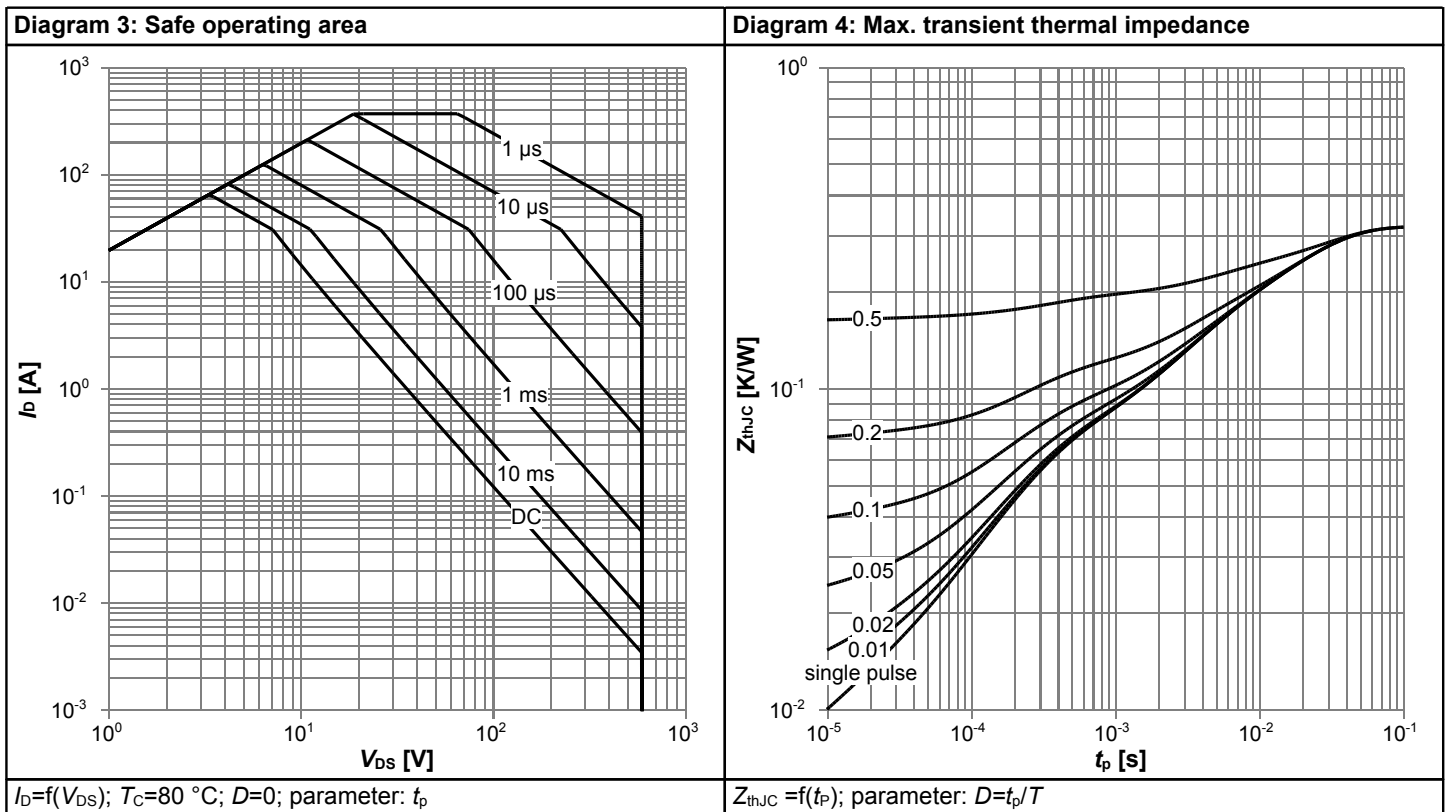
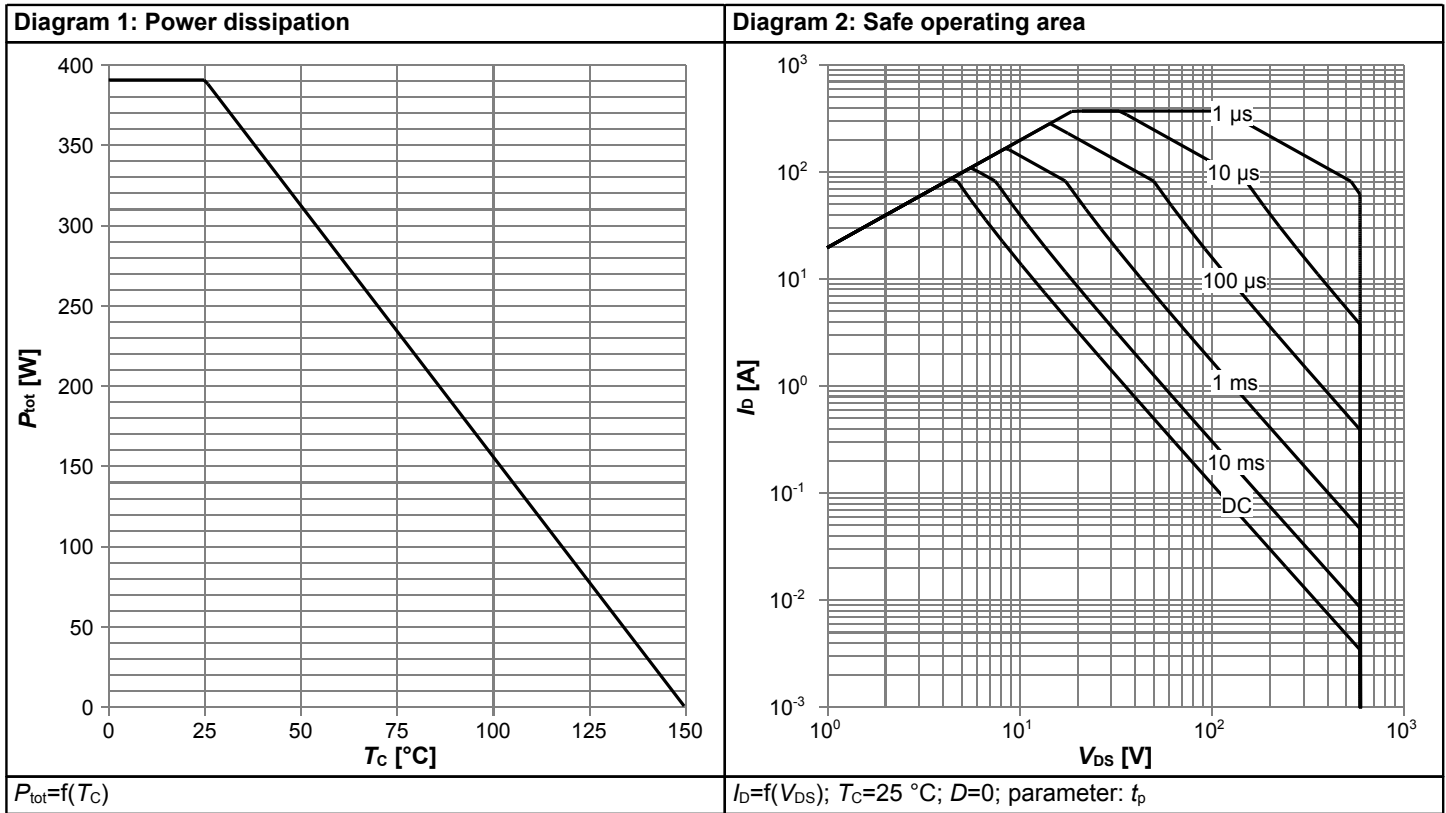
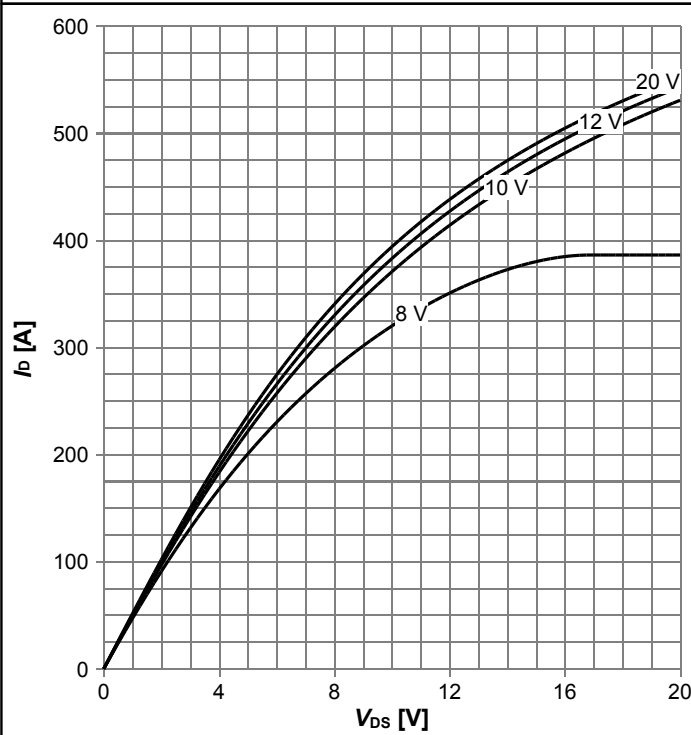

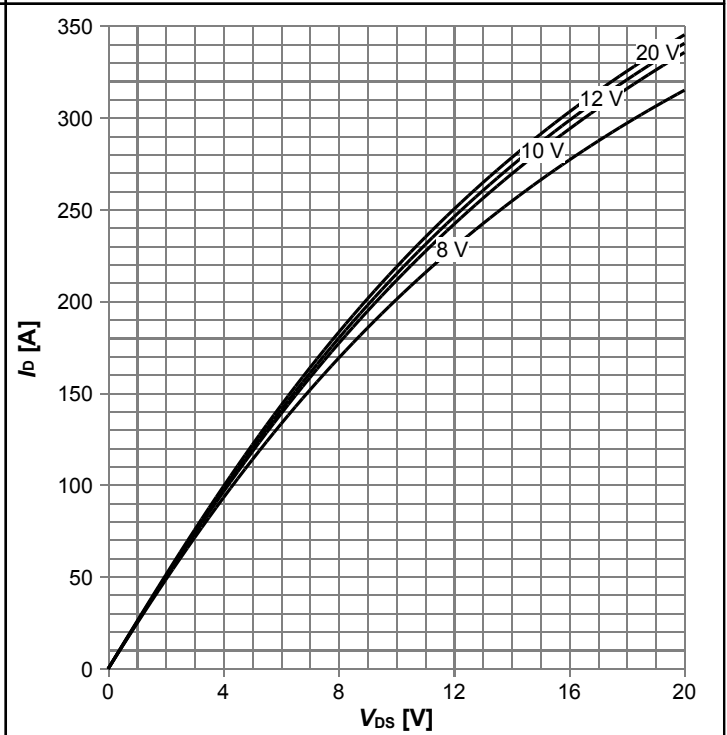

Diagram 5: Typ. output characteristics



$I_D=f(V_{DS})$ ;  $T_j=25\text{ °C}$ ; parameter:  $V_{GS}$

Diagram 6: Typ. output characteristics



$I_D=f(V_{DS})$ ;  $T_j=125\text{ °C}$ ; parameter:  $V_{GS}$

Diagram 7: Typ. drain-source on-state resistance

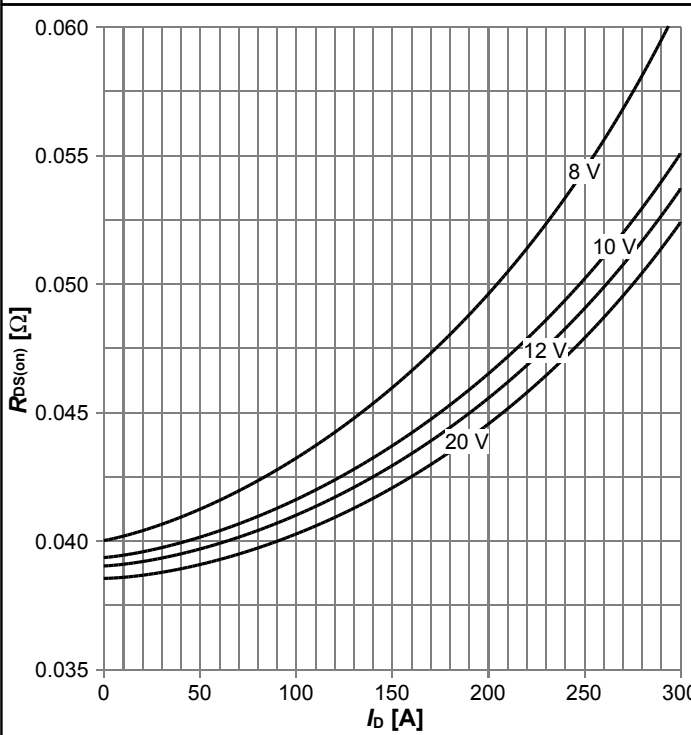

$R_{DS(on)}=f(I_D)$ ;  $T_j=125\text{ °C}$ ; parameter:  $V_{GS}$

Diagram 8: Drain-source on-state resistance

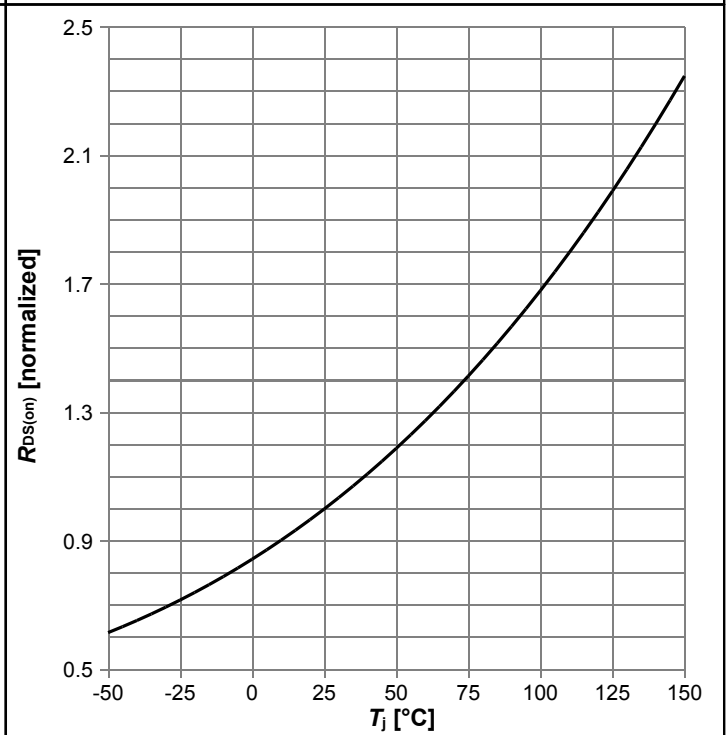

$R_{DS(on)}=f(T_j)$ ;  $I_D=23.0\text{ A}$ ;  $V_{GS}=12\text{ V}$

Diagram 9: Typ. transfer characteristics

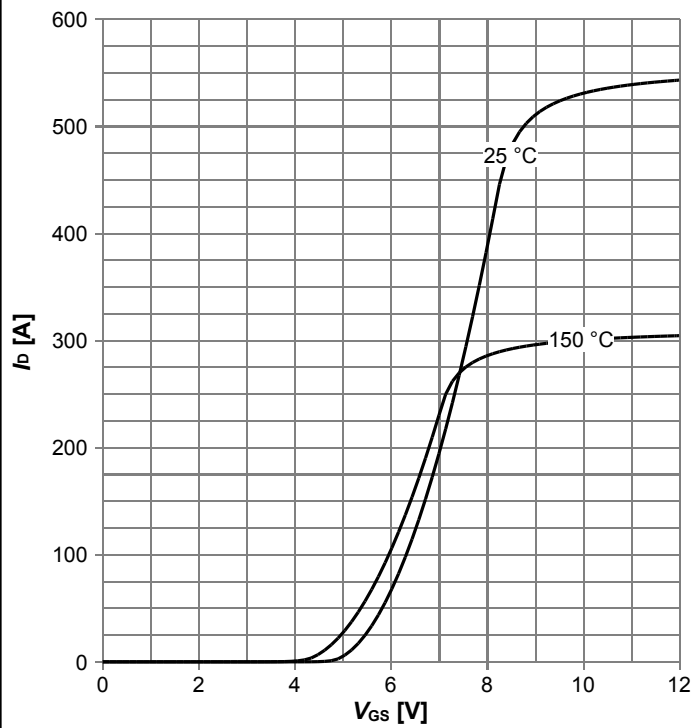

$I_D = f(V_{GS})$ ;  $V_{DS} = 20V$ ; parameter:  $T_j$

Diagram 10: Typ. gate charge

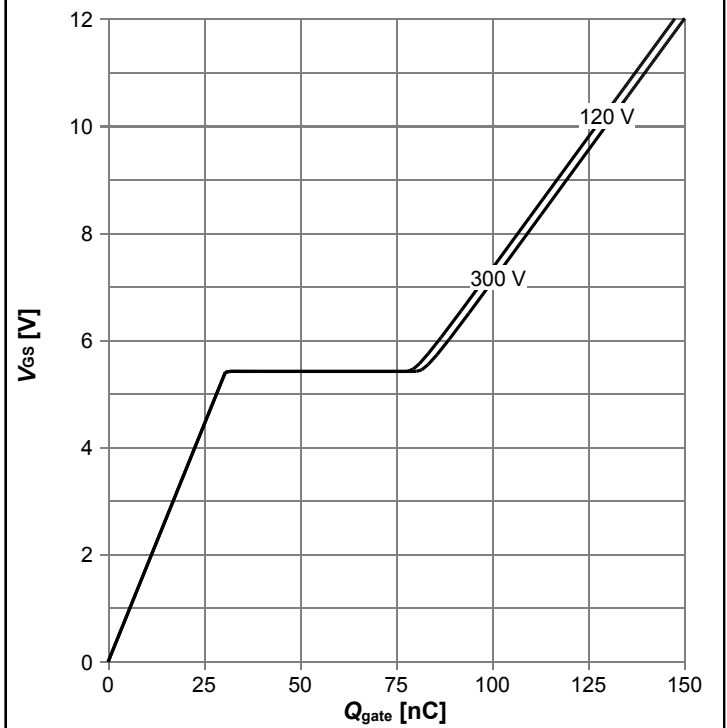

$V_{GS} = f(Q_{gate})$ ;  $I_D = 23.0 A$  pulsed; parameter:  $V_{DD}$

Diagram 11: Forward characteristics of reverse diode

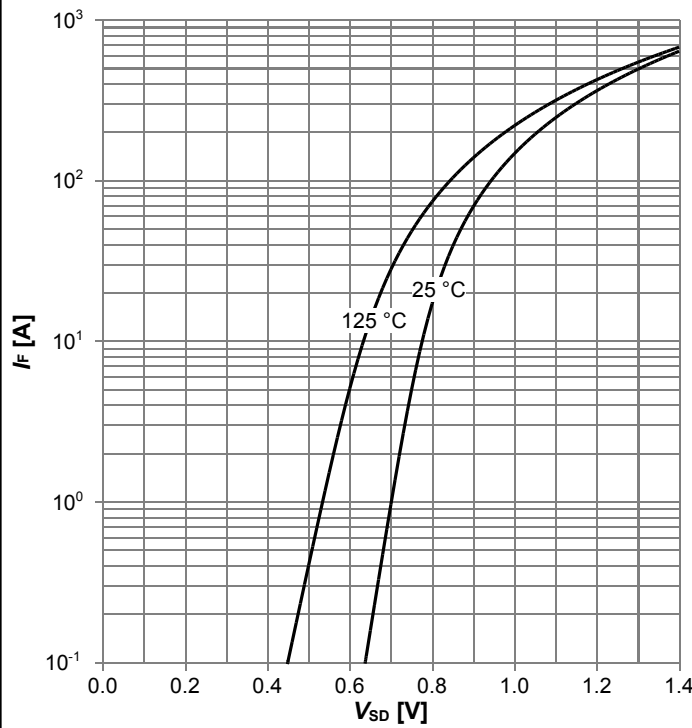

$I_F = f(V_{SD})$ ;  $V_{GS} = 0 V$ ; parameter:  $T_j$

Diagram 12: Forward characteristics of reverse diode

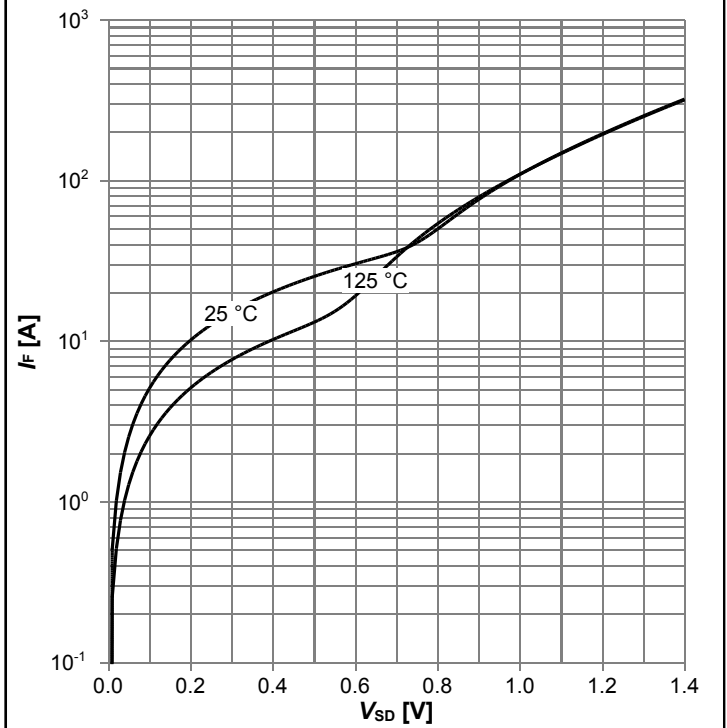

$I_F = f(V_{SD})$ ;  $V_{GS} = 12 V$ ; parameter:  $T_j$

Diagram 13: Avalanche energy

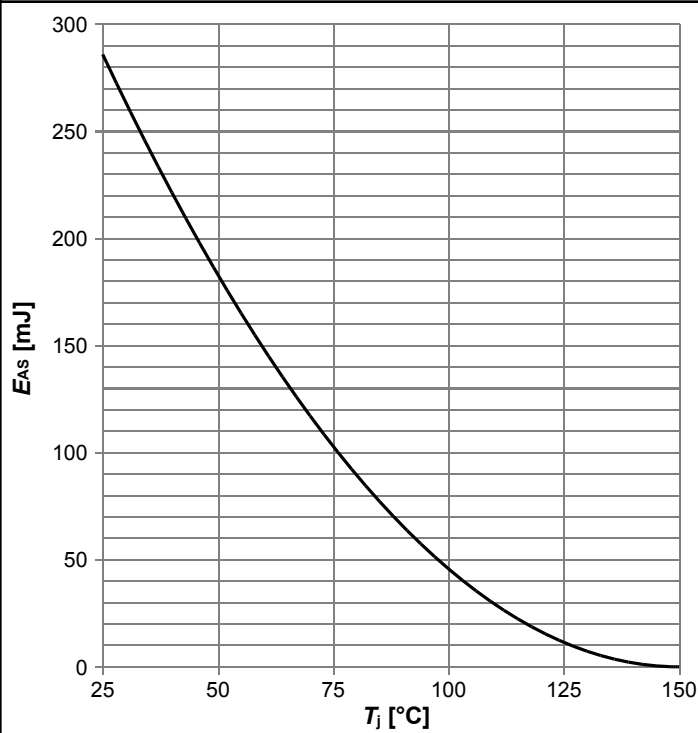

$E_{AS}=f(T_j)$ ;  $I_D=3.7$  A;  $V_{DD}=50$  V

Diagram 14: Drain-source breakdown voltage

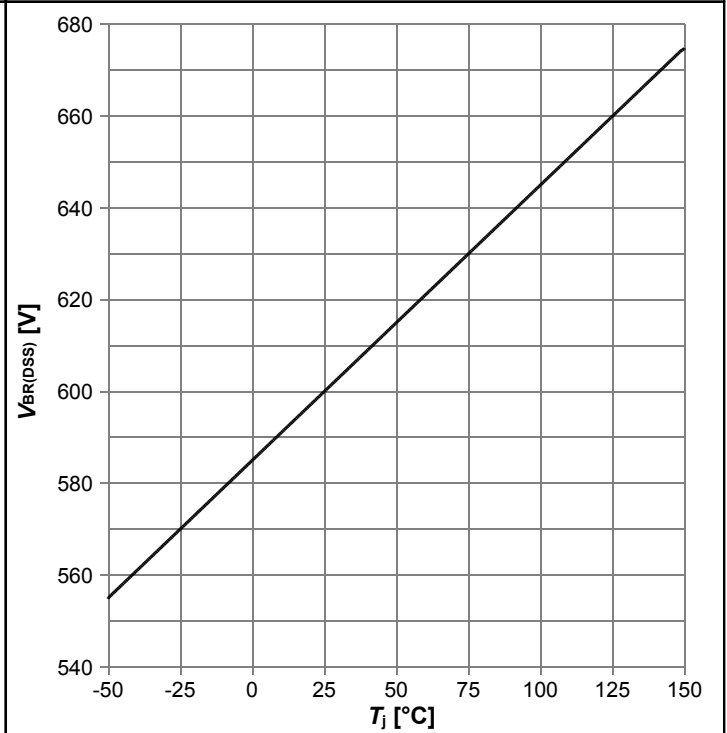

$V_{BR(DSS)}=f(T_j)$ ;  $I_D=1$  mA

Diagram 15: Typ. capacitances

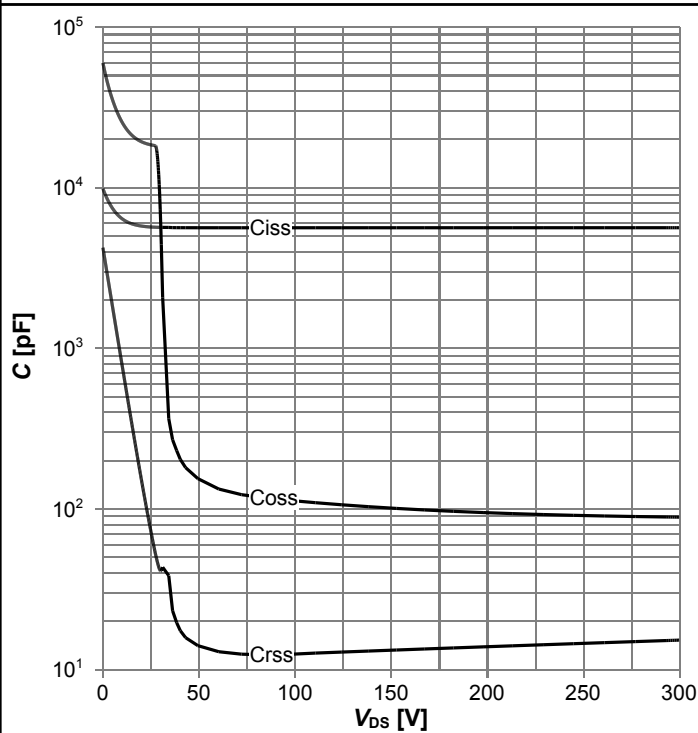

$C=f(V_{DS})$ ;  $V_{GS}=0$  V;  $f=250$  kHz

Diagram 17: Typ. Qoss output charge

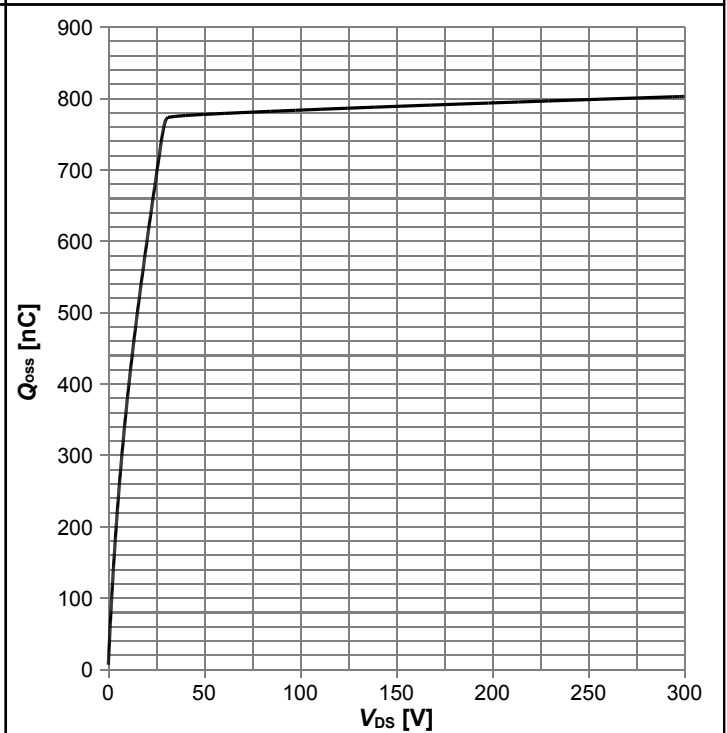

$Q_{oss}=f(V_{DS})$ ;  $V_{GS}=0$  V

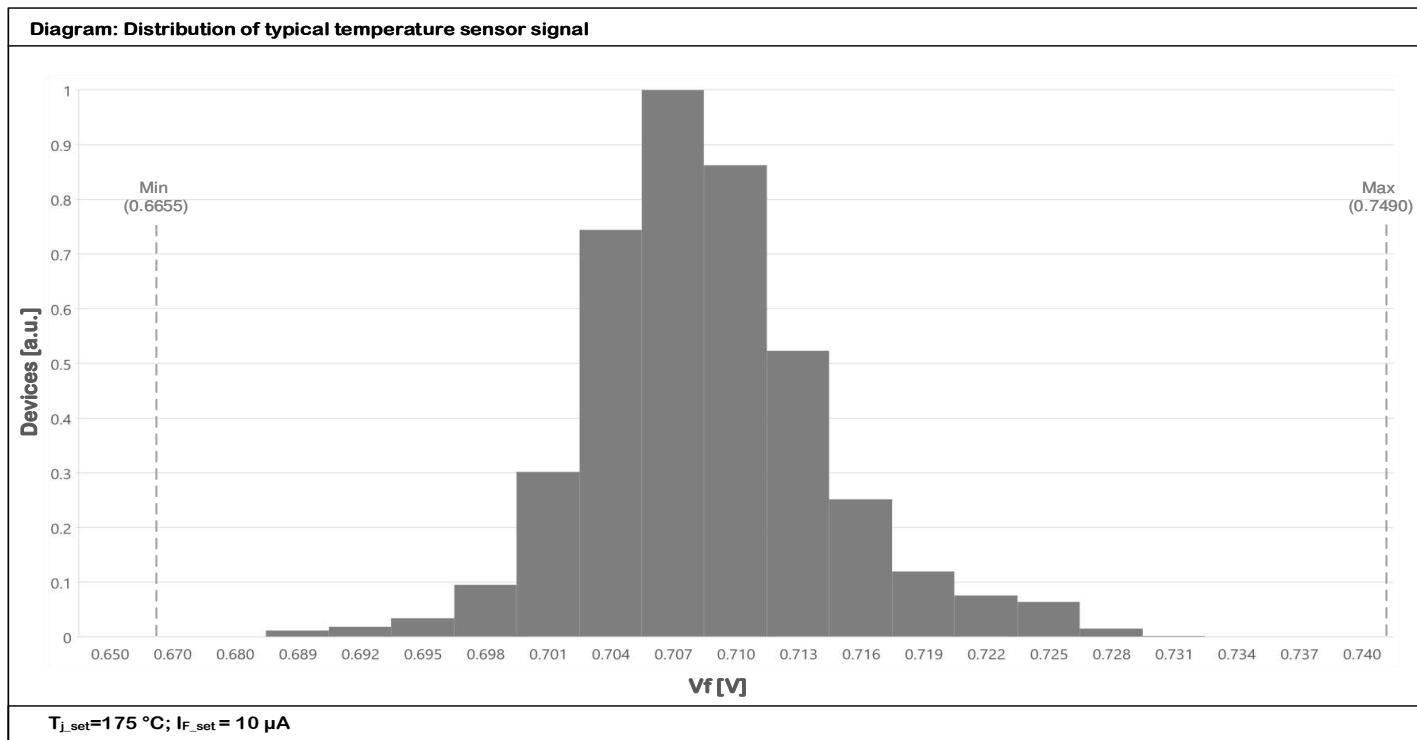

## 6 Test Circuits

**Table 10 Diode characteristics**

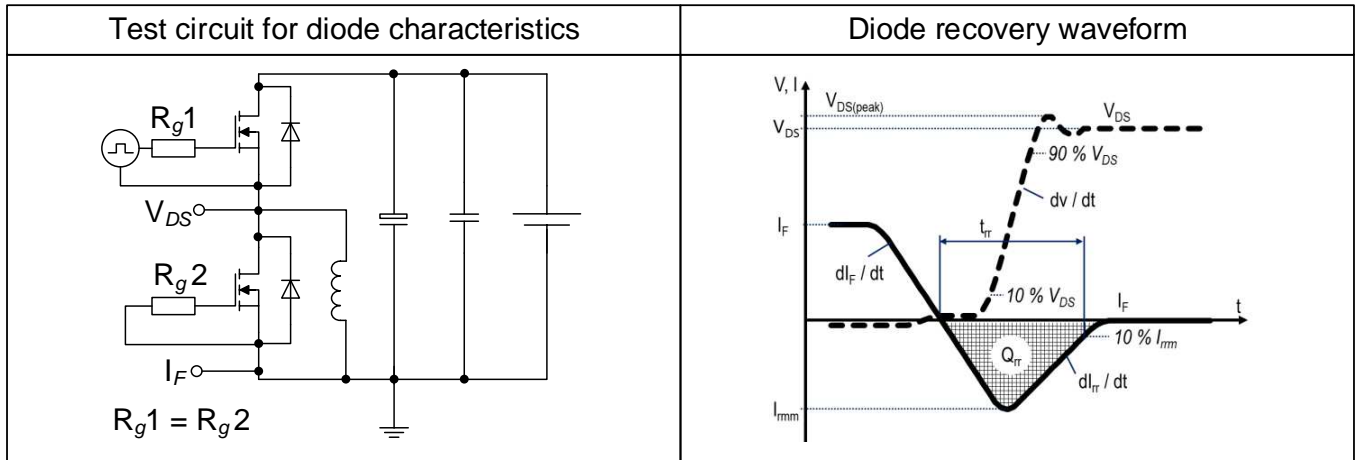

**Table 11 Switching times (ss)**

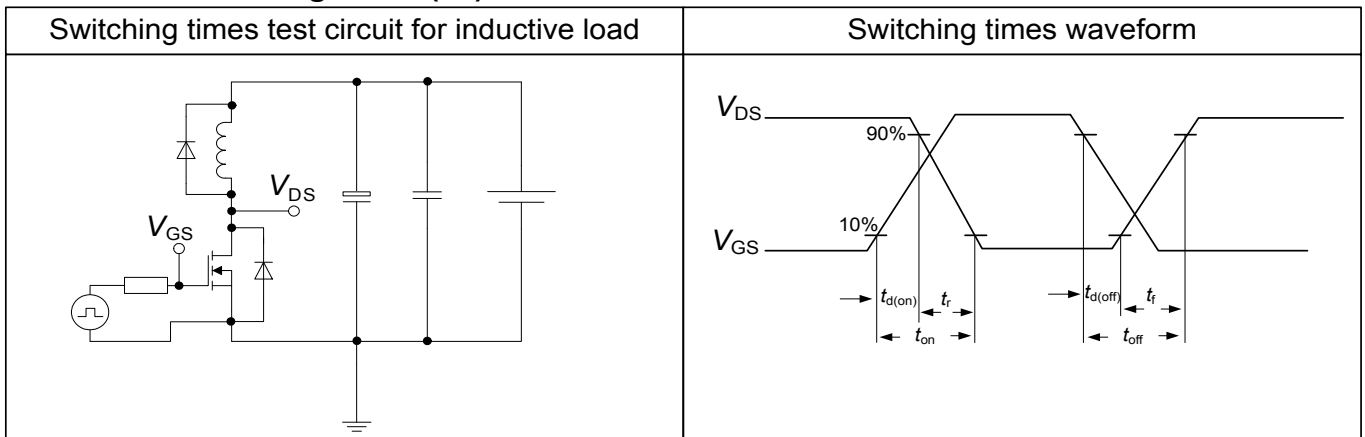

**Table 12 Unclamped inductive load (ss)**

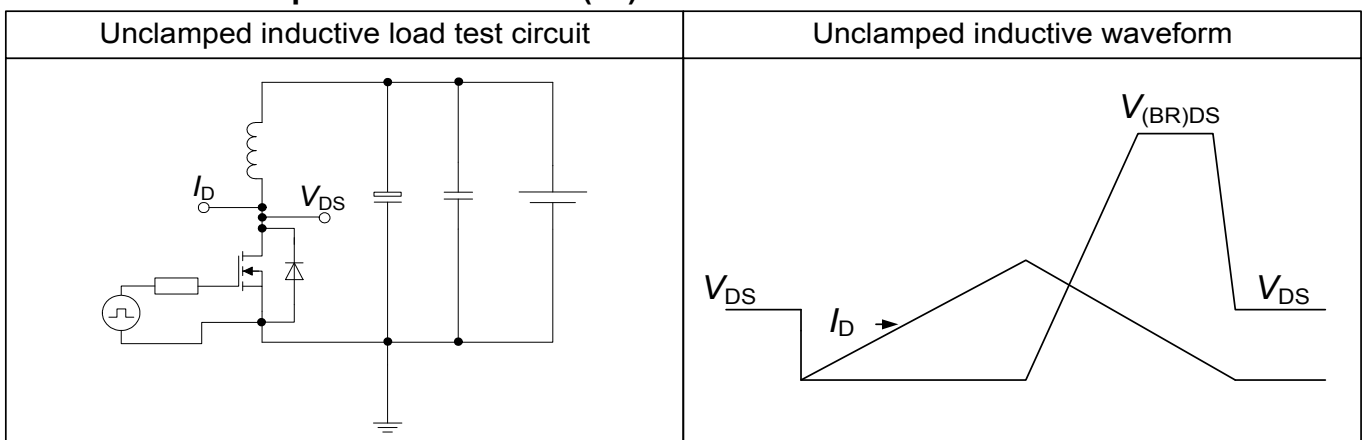

## 7 Package Outlines

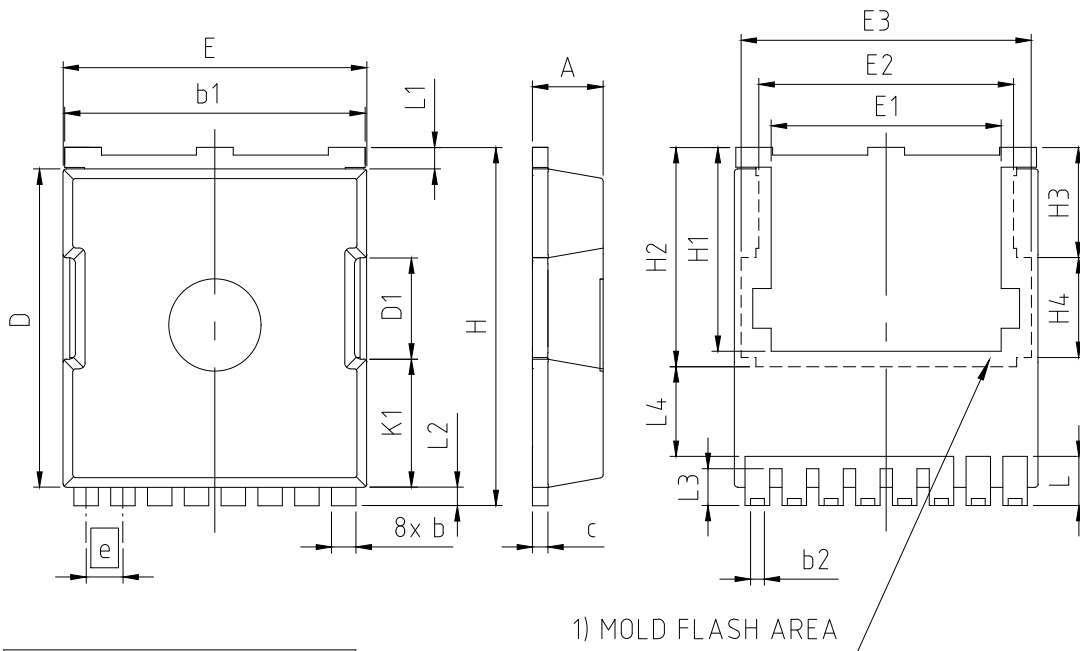

1) MOLD FLASH AREA

PACKAGE - GROUP NUMBER:		PG-HSOF-8-U02	
DIMENSIONS	MILLIMETERS		
	MIN.	MAX.	
A	2.20	2.40	
b	0.70	0.90	
b1	9.70	9.90	
b2	0.42	0.50	
c	0.40	0.60	
D	10.28	10.58	
D1	3.30		
E	9.70	10.10	
E1	7.50		
E2	8.50		
E3	9.46		
e	1.20 (BSC)		
H	11.48	11.88	
H1	6.55	6.95	
H2	7.15		
H3	3.59		
H4	3.26		
N	8		
K1	4.18		
L	1.40	1.80	
L1	0.50	0.90	
L2	0.50	0.70	
L3	1.00	1.30	
L4	2.62	2.81	

1) PARTIALLY COVERED WITH MOLD FLASH

Figure 1 Outline PG-HSOF-8, dimensions in mm

## 8 Appendix A

### Table 13 Related Links

- IFX CoolMOS S7T Webpage: [www.infineon.com](http://www.infineon.com)
- IFX CoolMOS S7T application note: [www.infineon.com](http://www.infineon.com)
- IFX CoolMOS S7T simulation model: [www.infineon.com](http://www.infineon.com)
- IFX Design tools: [www.infineon.com](http://www.infineon.com)

## Revision History

IPT60T022S7

**Revision: 2023-09-18, Rev. 2.0**

Previous Revision

Revision	Date	Subjects (major changes since last revision)
2.0	2023-09-18	Release of final version

### Trademarks

All referenced product or service names and trademarks are the property of their respective owners.

### We Listen to Your Comments

Any information within this document that you feel is wrong, unclear or missing at all? Your feedback will help us to continuously improve the quality of this document. Please send your proposal (including a reference to this document) to:

[erratum@infineon.com](mailto:erratum@infineon.com)

### Published by

**Infineon Technologies AG**

**81726 München, Germany**

**© 2023 Infineon Technologies AG**

**All Rights Reserved.**

### Legal Disclaimer

The information given in this document shall in no event be regarded as a guarantee of conditions or characteristics ("Beschaffungsgarantie").

With respect to any examples, hints or any typical values stated herein and/or any information regarding the application of the product, Infineon Technologies hereby disclaims any and all warranties and liabilities of any kind, including without limitation warranties of non-infringement of intellectual property rights of any third party.

In addition, any information given in this document is subject to customer's compliance with its obligations stated in this document and any applicable legal requirements, norms and standards concerning customer's products and any use of the product of Infineon Technologies in customer's applications.

The data contained in this document is exclusively intended for technically trained staff. It is the responsibility of customer's technical departments to evaluate the suitability of the product for the intended application and the completeness of the product information given in this document with respect to such application.

### Information

For further information on technology, delivery terms and conditions and prices please contact your nearest Infineon Technologies Office ([www.infineon.com](http://www.infineon.com)).

### Warnings

Due to technical requirements, components may contain dangerous substances. For information on the types in question, please contact the nearest Infineon Technologies Office.

The Infineon Technologies component described in this Data Sheet may be used in life-support devices or systems and/or automotive, aviation and aerospace applications or systems only with the express written approval of Infineon Technologies, if a failure of such components can reasonably be expected to cause the failure of that life-support, automotive, aviation and aerospace device or system or to affect the safety or effectiveness of that device or system. Life support devices or systems are intended to be implanted in the human body or to support and/or maintain and sustain and/or protect human life. If they fail, it is reasonable to assume that the health of the user or other persons may be endangered.