

PD30CNP50xxPS



Photoelectrics, Polarized retro-reflective - PointSpot



Main features

- Miniature sensor range
- PointSpot light source
- Sensing range: 5 m
- Sensitivity adjustment by potentiometer
- Modulated, red light 621 nm
- Supply voltage: 10 to 30 VDC
- Output: 100 mA, NPN or PNP preset
- Make and break switching function
- LED indication for output, stability and power ON
- Protection: reverse polarity, short circuit and transients
- Cable and plug versions
- Excellent EMC performance
- Easy mounting since only the sensor must be aligned with the reflector
- Power supply necessary only on one side of the application

Description

The PD30CNP50... sensor family comes in a compact 10 x 30 x 20 mm ABS housing. They are designed for use in applications where a compact lightbeam without "halo" light is required to assure a high sensing performance. The potentiometer function for adjustment of the sensitivity makes the sensors highly flexible. The output types NPN or PNP feature both N.O. and N.C. output.

Main functions

- Detects presence or absence of objects that cut off light reflected from a reflector
- The polarized light makes it possible to detect highly reflecting objects
- The PointSpot light source removes halo light and increases detection reliability.

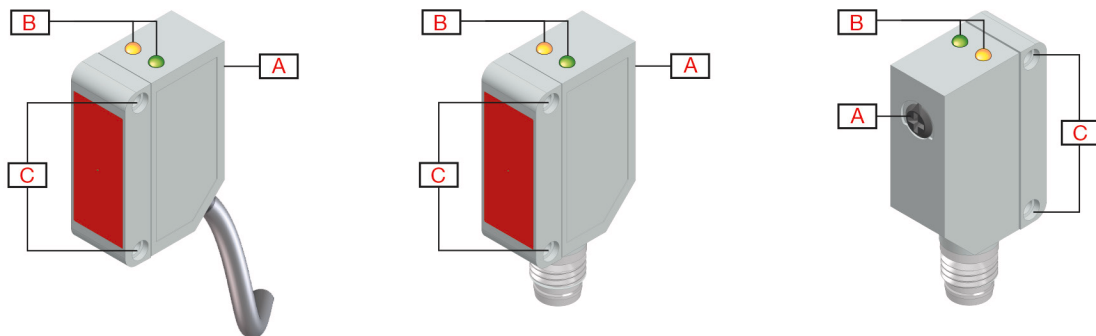

Element	Component	Function
A	Potentiometer	Adjustment
B	2 LEDs	Green LED: Power ON / Signal stability. Yellow LED: Output
C	2 M3	Fixing holes for sensor mounting



References

Product selection key

PD30CNP50 A PS

Enter the code option instead of

Code	Option	Description
P	-	Photoelectric sensor
D	-	Rectangular housing
30	-	Length of housing
C	-	Plastic housing
N	-	Normal trimmer (back trimmer)
P	-	Polarized retro-reflective
50	-	Distance [dm]
<input type="checkbox"/>	N	NPN
	P	PNP
A	-	Output: N.O. and N.C.
<input type="checkbox"/>	-	Cable, 2 m
	M5	Connector M8
PS	-	PointSpot emitter

Type selection

Conne- ction	Output	Code
Cable	NPN	PD30CNP50NAPS
	PNP	PD30CNP50PAPS
Plug	NPN	PD30CNP50NAM5PS
	PNP	PD30CNP50PAM5PS

Sensing

Detection

Rated operating distance (S_n)	≤ 5 m	@ Reference target, reflector: ER4 (Ø80 mm)
	≤ 3 m	@ Reference target, reflector: ER4060
Sensitivity adjustment	2.5 ... 5 m	Single-turn potentiometer
	210°	Electrical adjustment
	240°	Mechanical adjustment
Blind zone	≤ 100 mm @ S _n max	@ Reference target, reflector: ER4 (Ø80 mm) or ER4060
Hysteresis	3% ... 20%	
Light source	621 nm	Red - PointSpot
Light type	Red modulated	
Detection angle	± 0.6°	@ 2.5 m (half sensing distance)
Light spot size	9.5 cm	@ 2.5 m (half sensing distance)
Emitter beam angle	± 1.0°	@ 2.5 m (half sensing distance)

Accuracy

Temperature drift	≤ 0.2%/°C
--------------------------	-----------

Detection diagram

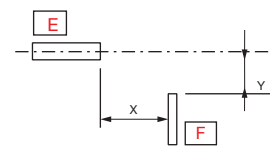
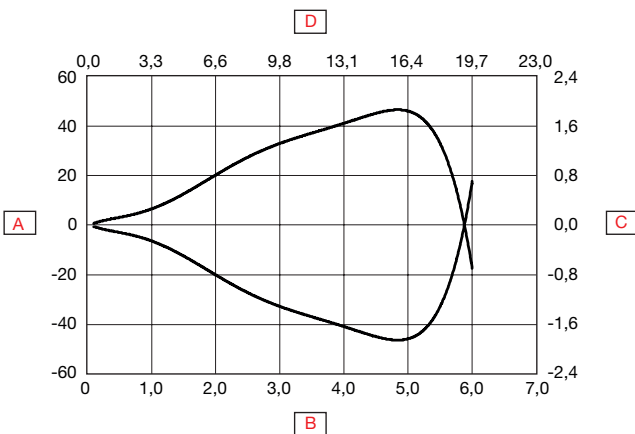

A	Detection width (mm)	D	Sensing range (feet)
B	Sensing range (m)	E	Sensor
C	Detection width (inches)	F	ER4 reflector



Excess gain

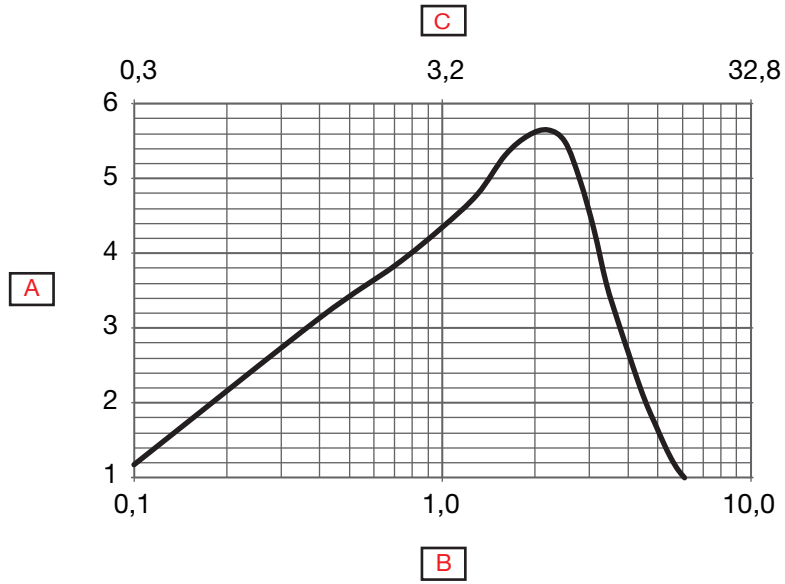

A	Excess gain	C	Distance (feet)
B	Distance (m)		



Features

Power Supply

Rated operational voltage (U_B)	10 ... 30 VDC (ripple included)
Ripple (U_{rpp})	$\leq 10\%$
No load supply current (I_o)	≤ 25 mA @ U_B Max.
Power-ON delay (t_v)	≤ 30 ms

Outputs

Output functions	NPN or PNP by sensor type	Open collector
Output switching function	N.O. and N.C.	
Output current	< 100 mA	Continuous(I_o)
	≤ 100 mA @ 100 nF load	Short-time (I)
Minimum operational current (I_m)	0.5 mA	
OFF-state current(I_r)	100 μ A	
Voltage drop (U_d)	2 VDC @ (I_o) Max.	
Protection	Short circuit, reverse polarity and transients	
Utilization category	DC-12	Control of resistive loads and solid-state loads with optical isolation
	DC-13	Control of electromagnets

Operation diagram

T_v = Power-ON delay

Power supply	ON	
Target	Present	
Break output (N.C.)	ON	
Make output (N.O.)	ON	

Response times

Operating frequency (f)	≤ 1000 Hz	
Response times	≤ 0.5 ms	OFF-ON (t_{ON})
	≤ 0.5 ms	ON-OFF (t_{ON})



Indication

Green LED	Yellow LED	Power	Output
ON	OFF	ON	OFF (stable)*
OFF	OFF	ON or OFF	OFF
OFF	ON	ON	ON
ON	ON	ON	ON (stable)*

*See signal stability curve

Signal stability indication

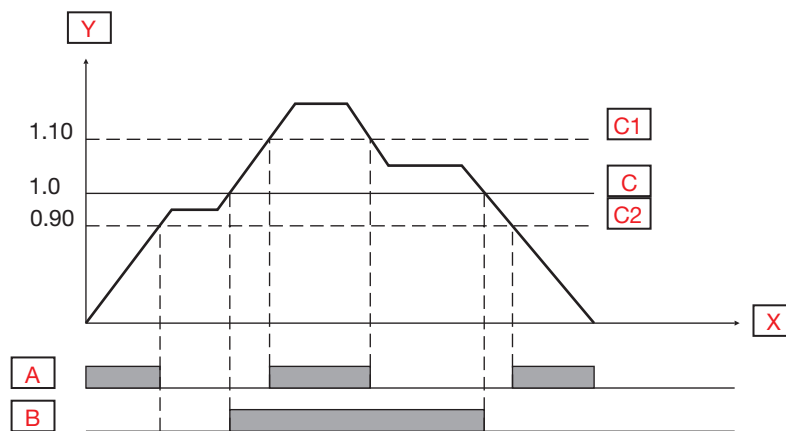

A	Green LED ON	C1	Operation level x 1.10
B	Yellow LED OFF	C	Operation level
X	Time	C2	Operation level x 0.90
Y	Excess gain		

Environmental

Ambient temperature	-25°... +60°C (-13°... +140°F)	Operating ¹⁾
	-40° ... +70°C (-40° ... +158°F)	Storage ¹⁾
Ambient light	≤ 45 000 lux	@ 3000 ... 3200 °K
Vibration	10 ...150 Hz, 1.0 mm/15 g	EN 60068-2-6
Shock	30 g _n / 11ms, 6 pos, 6 neg per axis	EN60068-2-27
Drop test	2 x 1 m and 100 x 0.5 m	EN 60068-2-31
Rated insulation voltage (U_i)	50 VDC	
Dielectric insulation voltage	≥ 500 VAC rms	50/60 Hz for 1 min.
Rated impulse withstand voltage	1 kV	1.2/50 μs
Pollution degree	3	EN60947-1
Overvoltage category	III	IEC60664; EN60947-1
Degree of protection	IP67	IEC60539; EN60947-1
NEMA Enclosure Types	1	NEMA 250
Ambient humidity range	35% ... 95%	Operating ²⁾
	35% ... 95%	Storage ²⁾

¹⁾ Do not bend the cable in temperatures below -10°C

²⁾ With no icing or condensation

EMC

Electrostatic discharge immunity test	± 8 kV @ air discharge or ± 4 kV @ contact discharge	IEC 61000-4-2
Radiated radio-frequency electromagnetic field immunity test (80 MHz ... 1 GHz and 1..4 GHz ... 2 GHz)	10 V/m	IEC 61000-4-3
Electrical fast transient/Burst immunity test	2 kV / 5 kHz using the capacitive coupling clamp	IEC 61000-4-4
Conducted disturbances induced by radio-frequency fields immunity test (150 kHz ... 80 MHz)	10 Vrms	IEC 61000-4-6
Power frequency magnetic field immunity test	30 A/m 38 µT	IEC 61000-4-8

Mechanics/electronics

▶ Connection

Cable	2 m, 4-wire 4 x 0.14 mm ² , Ø = 3.3 mm, PVC, Black
Plug	M8, 4-pin, male

▶ Wiring

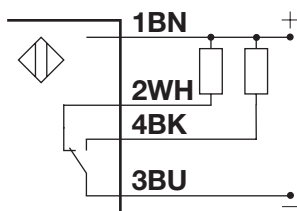

Fig. 1 NPN

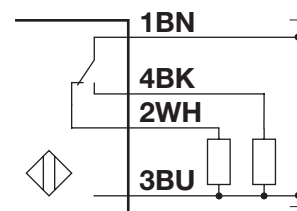

Fig. 2 PNP

BN	WH	BK	BU
Brown	White	Black	Blue

▶ Housing

Body	ABS	
Front glass	PMMA, Red	
Trimmer shaft	POM, Grey	
Indication	TPU	
Sealing	NBR70	
Dimensions	10.8 x 30 x 20 mm	
Weight	≤ 50 g	Cable version
	≤ 20 g	Plug version

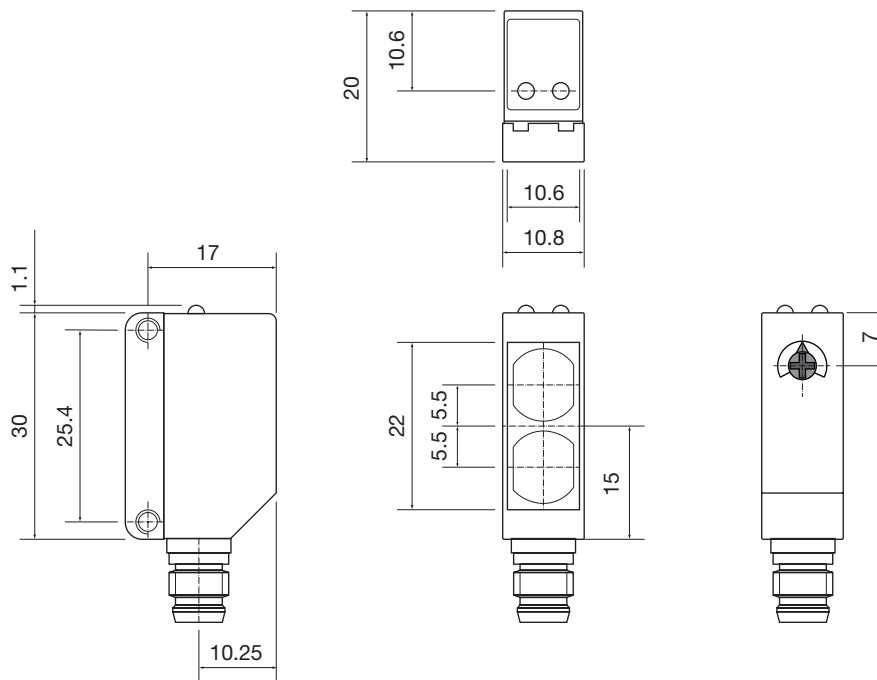
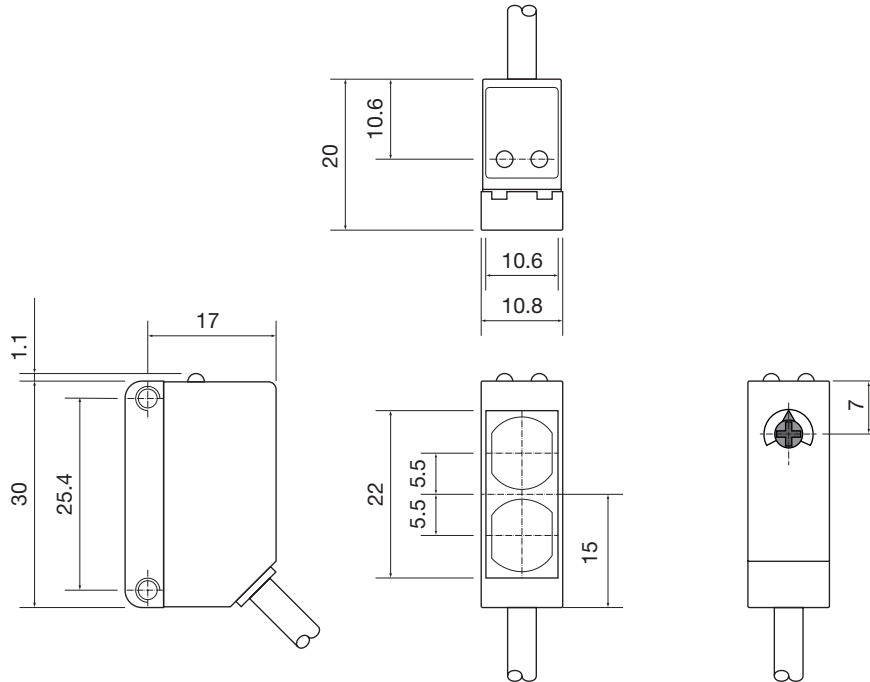

Dimensions





Compatibility and conformity

▶ Approvals and markings

General reference	Sensor designed according to EN60947-5-2	
MTTF_d	164.2 years @ 40°C (+104°F)	EN ISO 13849-1, SN 29500
CE-marking		
Approvals	 (UL508 + C22.2)	



Delivery contents and accessories



▶ Delivery contents

- Photoelectric switch: PD30CNP50...
- Screwdriver
- Packaging: Plastic bag

▶ Accessories

- Mounting bracket: ADP30-MB1 or APD30-MB2 to be purchased separately
- Connector type: CON.54NF.. series to be purchased separately
- ER.. Reflectors to be purchased separately

▶ Further information

Information	Where to find it	QR
Mounting brackets	http://cga.pub/?6fa29a	
Connectors	http://cga.pub/?ed457b	
ER.. Reflectors	http://cga.pub/?a7daed	



COPYRIGHT ©2022
 Content subject to change. Download the PDF: www.gavazziautomation.com