

Automotive Grade EMI Suppression Safety Capacitor, Ceramic Disc, Class X1, 760 V_{AC}, Class Y1, 500 V_{AC}



FEATURES

- AEC-Q200 qualified
- Withstands 85 / 85 / 1000 h test
- Can pass 1000 temperature cycles (from -55 °C to +125 °C)
- Can pass 10 kV pulses (10 per polarity)
- Complying with IEC 60384-14
- High reliability
- Singlelayer AC disc safety capacitors
- PPAP (AIAG version) is available
- Material categorization: for definitions of compliance please see www.vishay.com/doc?99912

LINKS TO ADDITIONAL RESOURCES



3D Models



Models



Capabilities and Custom Options



Infographics



Application Notes



Related Documents

QUICK REFERENCE DATA	
DESCRIPTION	VALUE
Ceramic Class	2
Ceramic Dielectric	Y5U
Voltage (V _{AC})	500 760
Min. Capacitance (pF)	470
Max. Capacitance (pF)	4700
Mounting	Radial

OPERATING TEMPERATURE RANGE

-55 °C to +125 °C

TEMPERATURE CHARACTERISTICS

Class 2: Y5U

SECTIONAL SPECIFICATIONS

Climatic category (according to EN 60058-1)

Class 2: 40 / 125 / 21

COATING

According to UL 94 V-0

Epoxy resin, isolating, flame retardant

APPROVALS

IEC 60384-14

UL 60384-14

DIN EN 60384-14

CSA E60384-1:03, CSA E60384-14:09

CQC (IEC 60384-14)

PACKAGING

Bulk, tape and reel, taped ammpack

APPLICATIONS

- X1, Y1 according to IEC 60384-14
- Application as Y capacitors for EMI suppression and primary-secondary coupling on battery chargers for PHEV/EV
- Application as filter capacitors on DC/DC converters for PHEV/EV and HEV
- EMI / RFI suppression and filtering

DESIGN

The capacitor consists of a ceramic disc which is copper plated on both sides. Connection leads are made of tin plated copper-clad steel having a diameter of 0.6 mm or 0.8 mm.

The capacitors may be supplied with straight and vertical kink leads having a lead spacing of 10.0 mm and 12.5 mm. Encapsulation is made of flame retardant epoxy resin in accordance with UL 94 V-0.

CAPACITANCE RANGE

470 pF to 4700 pF

RATED VOLTAGE U_R

IEC 60384-14:

 (X1): 760 V_{AC}, 50 Hz

 (Y1): 500 V_{AC}, 50 Hz

 1500 V_{DC}

TEST VOLTAGE

Component test (100 %):

 4000 V_{AC}, 50 Hz, 2 s

Random sampling test (destructive test):

 4000 V_{AC}, 50 Hz, 60 s

Voltage proof of coating (destructive test):

 4000 V_{AC}, 50 Hz, 60 s

INSULATION RESISTANCE

≥ 10 000 MΩ

CAPACITANCE TOLERANCE

± 20 % (code M)

DISSIPATION FACTOR

Class 2: max. 2.5 % (1 kHz)

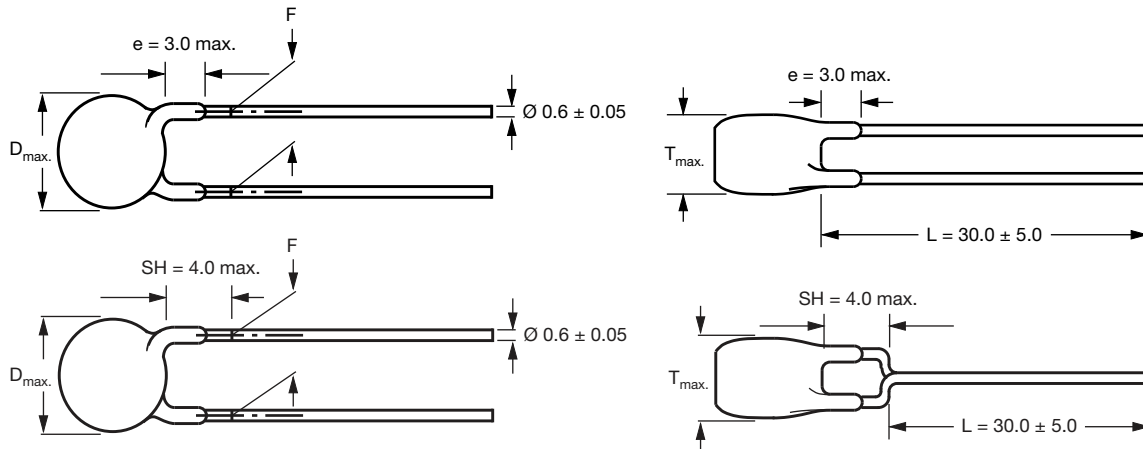
DIMENSIONS in millimeters

Capacitors with 10.0 mm or 12.5 mm lead spacing

TECHNICAL DATA

CAPACITANCE C (pF)	CAPACITANCE TOLERANCE (%)	BODY DIAMETER D _{max.} (mm)	BODY THICKNESS T _{max.} (mm)	LEAD SPACING F (mm) ± 1 mm	PART NUMBER
					MISSING DIGITS SEE ORDERING CODE BELOW
Y5U					
470	± 20	8.0	7.0	10 or 12.5	AY1471M31Y5UC6###
680		9.0		10 or 12.5	AY1681M35Y5UC6###
1000		9.5		10 or 12.5	AY1102M37Y5UC6###
1500		10.5		10 or 12.5	AY1152M41Y5UC6###
2200		12.0		10 or 12.5	AY1222M47Y5UC6###
2700		13.5		10 or 12.5	AY1272M53Y5UC6###
3300		14.5		10 or 12.5	AY1332M57Y5UC6###
3900		15.5		10 or 12.5	AY1392M61Y5UC6###
4700		16.5		10 or 12.5	AY1472M65Y5UC6###

ORDERING CODE

###	15 th to 17 th digit	Lead configuration			Available configurations see below					
Example	AY1	222	M	47	Y5U	C	6	U	L	0
	Series	Capacitance value	Tolerance code	Size code	Temperature coefficient	Compact design	Lead wire diameter	Packaging / lead length	Lead style	Lead spacing
							6 = 0.6 8 = 0.8	3 = bulk T = tape and reel U = ammpack	L = straight V = inline kink	0 = 10.0 X = 12.5

LEADSPACING 10.0 mm AND 12.5 mm
PACKAGING

CAPACITANCE VALUE	SIZE CODE	BODY DIAMETER D _{max.} (mm)	PACKAGING QUANTITIES		
			BULK	REEL	AMMO
470 pF to 2200 pF	31 to 47	12.0	1000	500	500
2700 pF to 4700 pF	53 to 65	16.5	500	500	500

Note

- The capacitors are supplied in bulk packaging (cardboard boxes), in tape on reel in ammpack

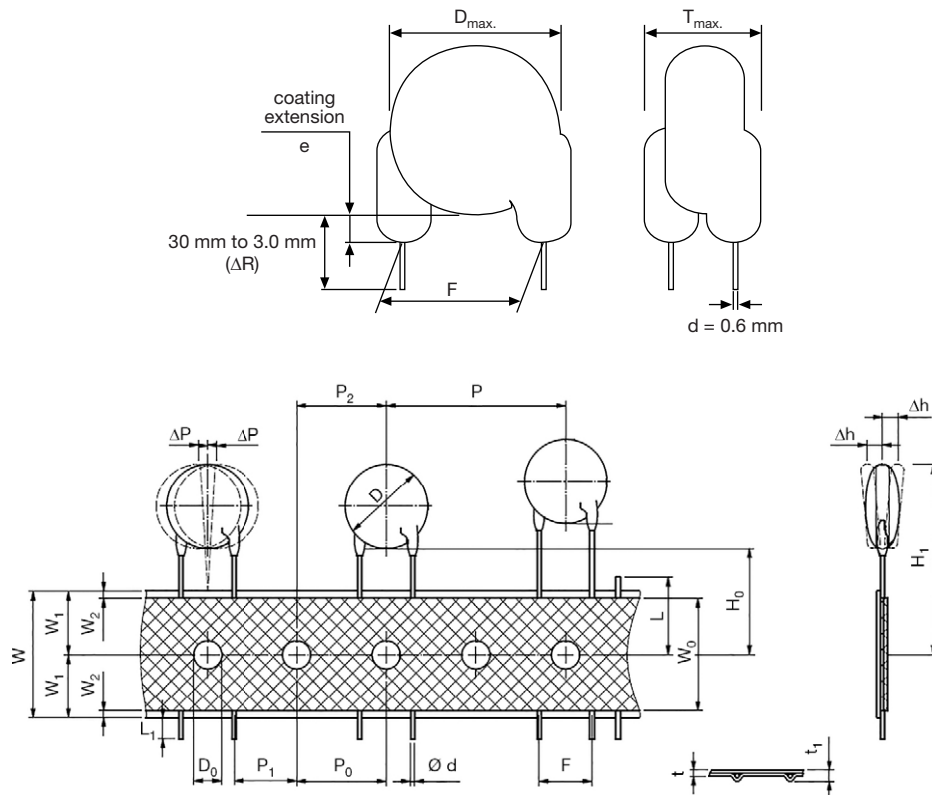
STRAIGHT LEADS

The hole pitch 12.7 mm for lead spacing 10.0 mm (0.4") or 12.5 mm (0.49")

DIMENSION OF TAPE		
SYMBOL	PARAMETER	DIMENSIONS (mm)
		10 mm OR 12.5 mm
D ⁽¹⁾	Body diameter	16.5 max.
d	Lead diameter	0.6 ± 0.05
P	Pitch of component	25.4 ± 1
P ₀ ⁽²⁾	Pitch of sprocket hole	12.7 ± 0.3
P ₁ ⁽³⁾	Distance, hole center to lead	7.7 or 6.5 ± 1.0
P ₂ ⁽³⁾	Distance, hole to center of component	12.7 ± 1.5
F	Lead spacing	10.0 or 12.5 (+ 0.6/- 0.4)
Δh	Average deviation across tape	± 1.0 max.
ΔP	Average deviation in direction of reeling	± 1.0 max.
W	Carrier tape width	18.0 + 1/- 0.5
W ₀	Hold-down tape width	5.0 min.
W ₁	Position of sprocket hole	9.0 + 0.75/- 0.5
W ₂	Distance of hold-down tape	3.0 max.
H ₁	Maximum component height	40
H ₀	Height to seating plane	20.0 ± 0.5 (16.0 ± 0.5 for kinked)
L	Length of cut leads	11.0 max.
L ₁	Length of lead protrusion	1.0 max.
D ₀	Diameter of sprocket hole	4.0 ± 0.2
t	Total tape thickness	0.9 max.
t ₁	Maximum thickness of tape and wires	1.5 max.

Notes

- (1) See "Technical Data" table
- (2) Cumulative pitch error: ± 1 mm/20 pitches
- (3) Obliquity maximum 3°

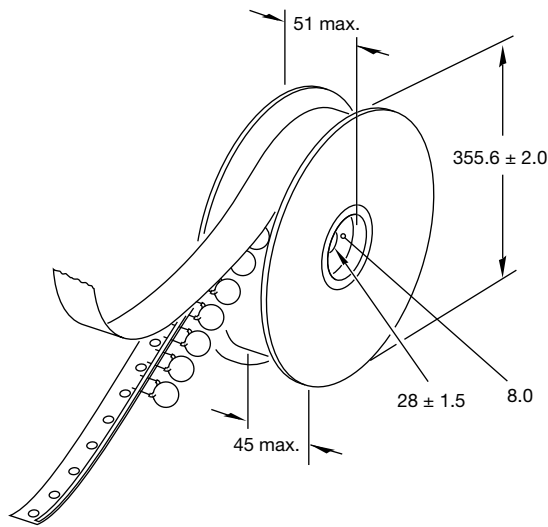
REEL AND TAPE DATA in millimeters

Reel with capacitors on tape

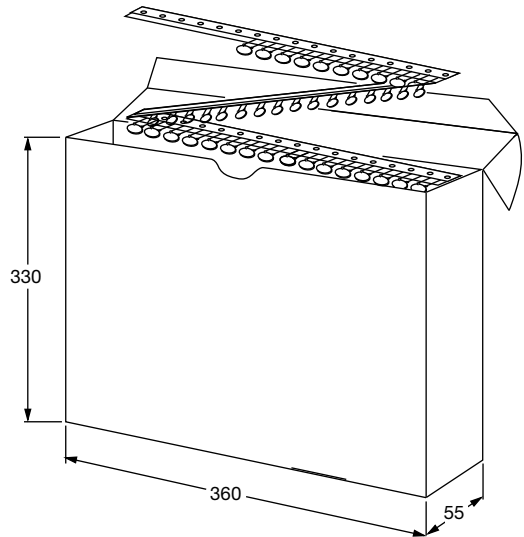

Ammpack with capacitors on tape

APPROVALS				
IEC 60384-14 - Safety tests This approval together with CB test certificate substitutes all national approvals.				
CB Certificate				
Y1-capacitor: CB test certificate:	US-26163-UL	470 pF to 4.7 nF	500 V _{AC}	
X1-capacitor: CB test certificate:	US-26163-UL	470 pF to 4.7 nF	760 V _{AC}	
VDE				
Y1-capacitor: VDE marks approval:	40012673	470 pF to 4.7 nF	500 V _{AC}	
X1-capacitor: VDE marks approval:	40012673	470 pF to 4.7 nF	760 V _{AC}	
DIN EN 60384-14 VDE 0565-1-1:2006-04 - Safety tests				
Underwriters Laboratories Inc./Canadian Standards Association				
Y1-capacitor: UL-test certificate:	E183844	470 pF to 4.7 nF	500 V _{AC}	
X1-capacitor: UL-test certificate:	E183844	470 pF to 4.7 nF	760 V _{AC}	
UL 60384-14, CSA E60384-1:03 2 nd edition, CSA E60384-14:09 2 nd edition Across-the-line, antenna-coupling and line-by-pass component				
CQC				
Y1-capacitor: CQC test certificate:	CQC05001015032	470 pF to 4.7 nF	500 V _{AC}	
X1-capacitor: CQC test certificate:	CQC05001015032	470 pF to 4.7 nF	760 V _{AC}	

MARKING	
<p>Sample (2 sides)</p> <div style="display: flex; justify-content: space-around; align-items: center;"> <div style="text-align: center;"> Front </div> <div style="text-align: center;"> Back </div> </div> <p style="margin-left: 100px;">XX - Year ΔΔ - Week</p>	 PN: Lot1: DC1: QTY: Lot2: DC2: PO: Batch: SL: SO: Region: Ser.No: <div style="text-align: right;">1/1</div>

PERFORMANCE						
NO.	ITEMS		SPECIFICATION	TEST METHOD		
1	Visual and mechanical examination		No visible damage. The marking shall be legible. Dimensions are within specification.	Capacitors shall be visually inspected for visible evidence of defect. Dimensions shall be measured with calipers or micrometers.		
2	Capacitance		Within the specified tolerance.	The capacitance shall be measured at 25 °C ± 3 °C, 75 % RH maximum with 1.0 V _{RMS} ± 0.2 V _{RMS} , 1 kHz.		
3	Dissipation factor (D.F.)		2.5 % max.	The dissipation factor shall be measured at 25 °C ± 3 °C, 75 % RH maximum with 1.0 V _{RMS} ± 0.2 V _{RMS} , 1 kHz.		
4	Insulation resistance (I.R.)		10 GΩ min.	Insulation resistance shall be measured within 60 s ± 5 s of charging at 500 V _{DC} .		
5	Dielectric strength (between lead wires)		No damage.	4000 V _{AC} are applied for 60 s. 50 mA max. (destructive test)		
6	Temperature characteristic		Within specification.	The capacitance shall be measured at each step specified in table below. The capacitance change from the value of step 3 shall not exceed the limit specified.		
					Step	Temperature
					1	25 °C ± 3 °C
					2	-30 °C ± 3 °C
					3	25 °C ± 3 °C
					4	85 °C ± 3 °C
7	High temperature operation life	External appearance	No visible damage. The marking shall be legible.	The specimen capacitors shall be submitted to an endurance test of 1000 h + 48 h / - 0 h in a chamber at 125 °C ± 3 °C with a voltage of 760 V _{AC} . Pre-treatment: capacitor shall be backed at 125 °C ± 3 °C for 1 h before initial measurements. Post-treatment: capacitors shall be placed at room condition for 24 h ± 2 h before measurements.		
		Capacitance change	± 15 % max.			
		Dissipation factor	5 % max. at 1 V, 1 kHz			
		Insulation resistance	3 GΩ min. at 500 V _{DC} , 60 s			
		Dielectric strength (between lead wires)	No failure at 4000 V _{AC} , 60 s			

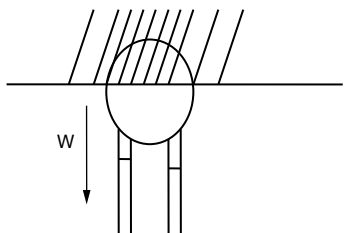
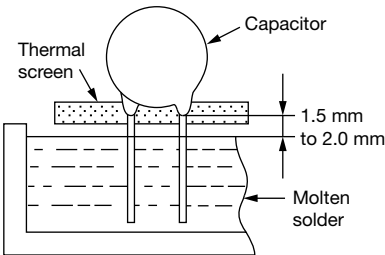

PERFORMANCE				
NO.	ITEMS		SPECIFICATION	TEST METHOD
8	Life test	External appearance	No visible damage. The marking shall be legible.	<p>Test voltage: 4000 V_{AC}, 60 s Impulse voltage: each individual capacitor shall be subjected to a 10 kV impulse for ten times each polarity. Before the capacitors are applied to life test.</p> <p>$T_1 = 1.2 \mu\text{s}$ $T_2 = 50 \mu\text{s}$</p> <p>The specimen capacitors shall be submitted to an endurance test of 1000 h + 48 h / - 0 h in a chamber at 125 °C ± 3 °C with a voltage of 1500 V_{AC}.</p> <p>Pre-treatment: capacitor shall be backed at 125 °C ± 3 °C for 1 h before initial measurements.</p> <p>Post-treatment: capacitors shall be placed at room condition for 24 h ± 2 h before measurements.</p>
		Capacitance change	± 15 % max.	
		Dissipation factor	5 % max. at 1 V, 1 kHz	
		Insulation resistance	3 GΩ min. at 500 V _{DC} , 60 s	
		Dielectric strength (between lead wires)	No failure at 4000 V _{AC} , 60 s	
9	Humidity test (under steady state)	External appearance	No visible damage.	<p>Ambient temperature: 40 °C ± 2 °C Relative humidity: 90 % to 95 % RH Duration: 500 h + 48 h / - 0 h Without loading</p> <p>Pre-treatment: capacitor shall be stored at 40 °C ± 2 °C for 24 h ± 5 h before initial measurements.</p> <p>Post-treatment: capacitor shall be stored for 2 h at room conditions before final measurements.</p>
		Capacitance change	± 20 %	
		Dissipation factor	5 % max. at 1 V, 1 kHz	
		Insulation resistance	3 GΩ min. at 500 V _{DC} , 60 s	
		Dielectric strength (between lead wires)	No failure at 4000 V _{AC} , 60 s	
10	Humidity test (under load state)	External appearance	No visible damage. The marking shall be legible.	<p>Ambient temperature: 40 °C ± 2 °C Relative humidity: 90 % to 95 % RH Duration: 500 h + 48 h / - 0 h Loading voltage: 760 V_{AC}</p> <p>Pre-treatment: capacitor shall be stored at 40 °C ± 5 °C for 24 h ± 2 h before initial measurements.</p> <p>Post-treatment: capacitor shall be stored for 2 h at room conditions before final measurements.</p>
		Capacitance change	± 15 %	
		Dissipation factor	5 % max. at 1 V, 1 kHz	
		Insulation resistance	3 GΩ min. at 500 V _{DC} , 60 s	
		Dielectric strength (between lead wires)	No failure at 4000 V _{AC} , 60 s	

PERFORMANCE						
NO.	ITEMS			SPECIFICATION	TEST METHOD	
11	Biased humidity	External appearance		No visible damage. The marking shall be legible.	Loading voltage: 760 V _{AC} Ambient temperature: 85 °C ± 3 °C Relative humidity: 85 % RH Duration: 1000 h + 48 h / - 0 h Pre-treatment: capacitor shall be stored at 40 °C ± 5 °C for 24 h ± 2 h, then place at room condition for 24 h ± 2 h before initial measurements. Post-treatment: capacitor shall be stored for 24 h at room conditions before final measurements.	
		Capacitance change		± 15 %		
		Dissipation factor		5 % max. at 1 V, 1 kHz		
		Insulation resistance		3 GΩ min. at 500 V _{DC} , 60 s		
		Dielectric strength (between lead wires)		No failure at 4000 V _{AC} , 60 s		
12	Termination strength	Pull test	External appearance	Lead wire should not be cut off, capacitor should not be broken.	As a figure, fix the body of capacitor, apply a tensile weight gradually to each lead wire in the radial direction of capacitor up to 20 N, and keep it for 10 s ± 1 s. 	
			Capacitance change	Within specification		
			Dissipation factor	Within specification		
			Insulation resistance	Within specification		
		Bending test	External appearance	Lead wire should not be cut off, capacitor should not be broken.		Bending each lead wire to 90° from the lead egress with 2.5 N force, then back to original position and bent again from the same direction. Totally 3 bends, 3 s each time. 1 bend: bending to 90° the return to normal position is one bend. Start from 1.6 mm to 3.2 mm from the part body.
			Visual			
13	Resistance to solder heat	Capacitance change		Within ± 10 %	The lead wire shall be immersed into the melted solder of 260 °C ± 5 °C up to about 1.5 mm to 2 mm from the main body for 10 s ± 2 s. Inspect under 10 x magnification 	
		Dissipation factor		5 % max. at 1 V, 1 kHz		
		Insulation resistance		1 GΩ min. at 500 V _{DC} , 60 s		
		Dielectric strength (between lead wires)		No failure at 4000 V _{AC} , 60 s		
		Pre-treatment:		Capacitor shall be stored at 125 °C ± 5 °C for 1 h, then placed at room condition for 24 h ± 2 h before initial measurements.		
Post-treatment:		Capacitor shall be stored for 24 h ± 2 h at room condition.				

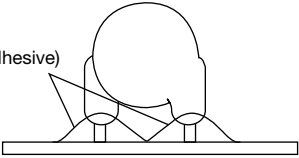
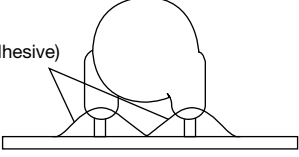
PERFORMANCE				
NO.	ITEMS		SPECIFICATION	TEST METHOD
14	Solderability	External appearance	95 % of terminations evenly covered with solder under 10 x magnification.	Method A at category 3, steam aging for 8 h ± 15 min. Solder and temperature: a) Lead (Pb)-free solder (Sn-3Ag-0.5Cu) 245 °C ± 5 °C b) H63 eutectic solder 235 °C ± 5 °C dip lead wire into an ethanol solution of 25 % ± 0.5 % rosin and then into molten solder for 5 s + 0 s / - 0.5 s. Depth of immersion within 1.25 mm, immerse and withdraw at 25 mm/s ± 6 mm/s
15	Vibration test	Visual	No visible damage. The marking shall be legible.	 <p>Resin (adhesive)</p> <p>Solder the capacitor and gum up the body to the test jig by resin (adhesive). The capacitor should be firmly soldered to the supporting lead wire. Vibration change from 10 Hz to 2000 Hz, then back to 10 Hz. Total amplitude: 1.5 mm with 5 g max., 12 cycles, 20 min for each mutually perpendicular directions, 3 directions.</p>
		Capacitance change	Within ± 10 %	
		Dissipation factor	5 % max. at 1 V, 1 kHz	
		Insulation resistance	10 GΩ min. at 500 V _{DC} , 60 s	
16	Mechanical shock	External appearance	No visible damage. The marking shall be legible.	 <p>Resin (adhesive)</p> <p>Solder the capacitor and gum up the body to the test jig by resin (adhesive). 3 shocks in 2 directions should be applied, totally 3 mutually perpendicular axes, 18 shocks. Shock from: half-sine Duration: 6 ms Acceleration: 100 g</p>
		Capacitance change	Within the specified tolerance.	
		Dissipation factor	5 % max. at 1 V, 1 kHz	
		Insulation resistance	10 GΩ min. at 500 V _{DC} , 60 s	
17	Resistance to solvents	External appearance	No visible damage. The marking shall be legible.	<p>Leave parts in solvent for 3 to 8 min at 25 °C ± 5 °C, 1 min air-drying Rub parts against wet bristle 10 times (3 x for marking, 10 x for part damage)</p> <p>Solvent 1: 1 part (by volume) of isopropyl alcohol, 3 parts (by volume) of mineral spirits</p> <p>Solvent 2: Terpene defluxer</p> <p>Solvent 3: 42 parts (by volume) of water, 1 part (by volume) of propylene glycol, 1 part (by volume) of monoethanolamine</p>



PERFORMANCE				
NO.	ITEMS		SPECIFICATION	TEST METHOD
18	Temperature cycle	Capacitance change	Within $\pm 20\%$	<p>The capacitor should be run 1000 temperature cycles. Step as below: Step 1-55 °C + 0 °C / - 3 °C, dwell time ≤ 30 min Step 2 Transition time ≤ 1 min Step 3+125 °C + 3 °C / - 0 °C, dwell time ≤ 30 min Step 4 Transition time ≤ 1 min</p> <p>Pre-treatment: capacitor shall be stored at 125 °C ± 3 °C for 1 h, then placed at room condition for 24 h ± 2 h before initial measurement.</p> <p>Post-treatment: capacitor shall be stored for 24 h ± 2 h at room condition.</p>
		Dissipation factor	5 % max. at 1 V, 1 kHz	
		Insulation resistance	3 G Ω min at 500 V _{DC} , 60 s	
		Dielectric strength	No failure at 4000 V _{AC} , 60 s	
		External appearance	No visible damage. The marking shall be legible.	
19	High temperature exposure (storage)	External appearance	No visible damage. The marking shall be legible.	<p>Storage capacitor at 125 °C ± 3 °C for 1000 h + 48 h / - 0 h without loading.</p> <p>Pre-treatment: capacitor shall be stored at 125 °C ± 3 °C for 1 h, then placed at room condition for 24 h ± 2 h before initial measurement.</p> <p>Post-treatment: capacitor shall be stored for 24 h ± 2 h at room condition.</p>
		Capacitance change	Within $\pm 20\%$	
		Dissipation factor	5 % max. at 1 V, 1 kHz	
		Insulation resistance	1 G Ω min. at 500 V _{DC} , 60 s	
20	ESD	External appearance	No visible damage. The marking shall be legible.	See chart "ESD Test Method" below
		Capacitance change	Within $\pm 10\%$	
		Dissipation factor	5 % max. at 1 V, 1 kHz	
		Insulation resistance	1 G Ω min. at 500 V _{DC} , 60 s	



ESD TEST METHOD

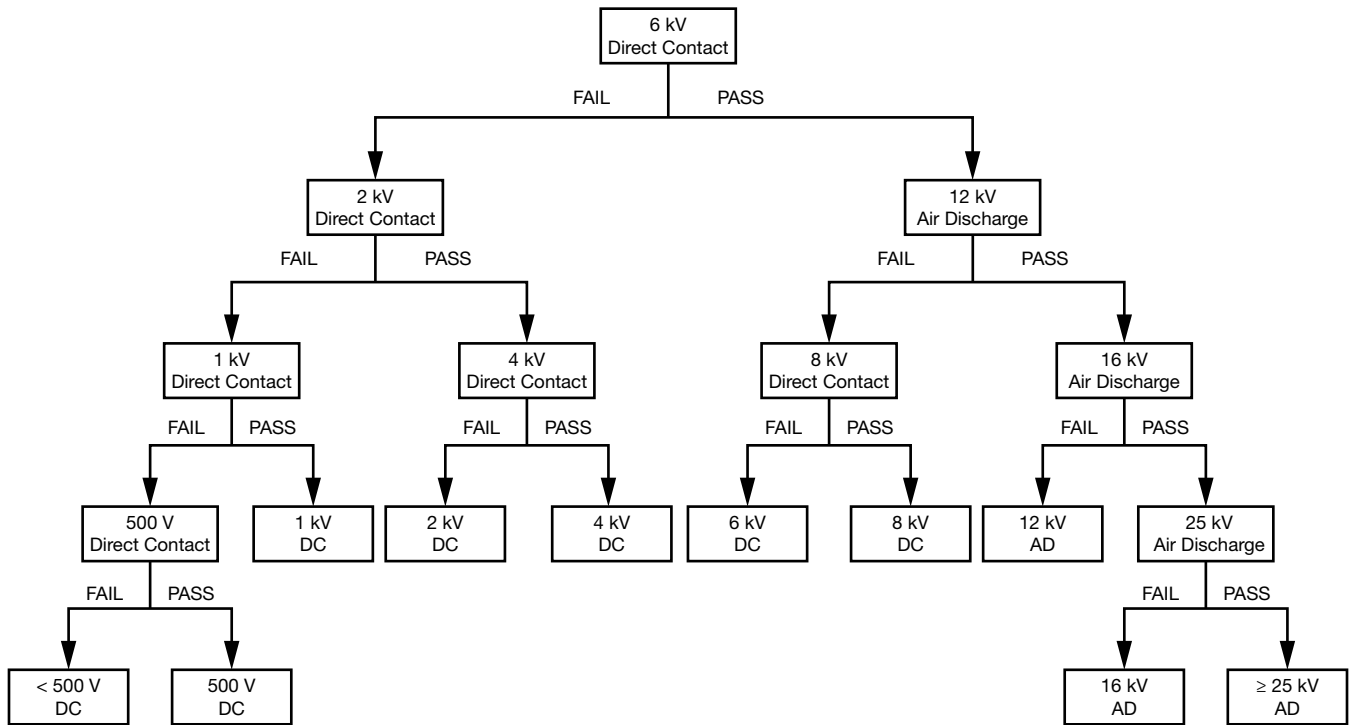

Notes

- DC means “direct contact discharge”
- AC means “air discharge”
- Classify the components according to the highest ESD voltage level survived during ESD testing



LEAKAGE CURRENT VS. VOLTAGE (Typical)

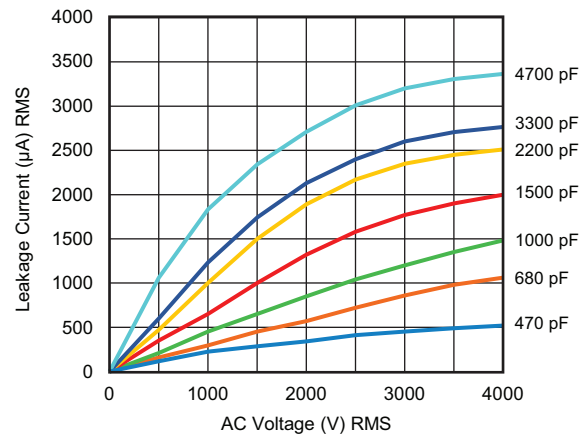

IMPEDANCE VS. FREQUENCY (Typical)

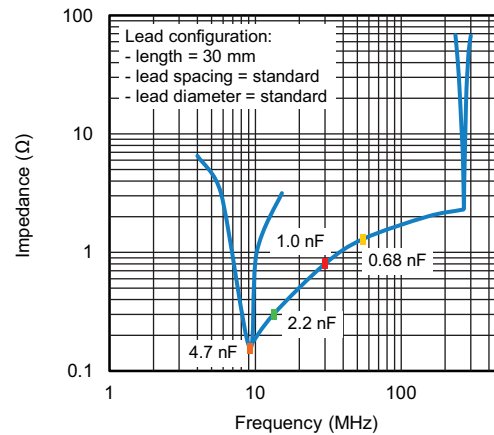

Note

- The capacitors meet the essential requirements of "EIA 198". Unless stated otherwise all electrical values apply at an ambient temperature of 25 °C ± 3 °C, at normal atmospheric conditions

RELATED DOCUMENTS	
General Information	www.vishay.com/doc?28536
VDE Marks Approval	www.vishay.com/doc?22251
UL Test Certificate	www.vishay.com/doc?22250
CQC Test Certificate	www.vishay.com/doc?22248

SAMPLE KIT	
Part Number	AY1-KIT-GA
Link	www.vishay.com/doc?28567



Disclaimer

ALL PRODUCT, PRODUCT SPECIFICATIONS AND DATA ARE SUBJECT TO CHANGE WITHOUT NOTICE TO IMPROVE RELIABILITY, FUNCTION OR DESIGN OR OTHERWISE.

Vishay Intertechnology, Inc., its affiliates, agents, and employees, and all persons acting on its or their behalf (collectively, "Vishay"), disclaim any and all liability for any errors, inaccuracies or incompleteness contained in any datasheet or in any other disclosure relating to any product.

Vishay makes no warranty, representation or guarantee regarding the suitability of the products for any particular purpose or the continuing production of any product. To the maximum extent permitted by applicable law, Vishay disclaims (i) any and all liability arising out of the application or use of any product, (ii) any and all liability, including without limitation special, consequential or incidental damages, and (iii) any and all implied warranties, including warranties of fitness for particular purpose, non-infringement and merchantability.

Statements regarding the suitability of products for certain types of applications are based on Vishay's knowledge of typical requirements that are often placed on Vishay products in generic applications. Such statements are not binding statements about the suitability of products for a particular application. It is the customer's responsibility to validate that a particular product with the properties described in the product specification is suitable for use in a particular application. Parameters provided in datasheets and / or specifications may vary in different applications and performance may vary over time. All operating parameters, including typical parameters, must be validated for each customer application by the customer's technical experts. Product specifications do not expand or otherwise modify Vishay's terms and conditions of purchase, including but not limited to the warranty expressed therein.

Hyperlinks included in this datasheet may direct users to third-party websites. These links are provided as a convenience and for informational purposes only. Inclusion of these hyperlinks does not constitute an endorsement or an approval by Vishay of any of the products, services or opinions of the corporation, organization or individual associated with the third-party website. Vishay disclaims any and all liability and bears no responsibility for the accuracy, legality or content of the third-party website or for that of subsequent links.

Except as expressly indicated in writing, Vishay products are not designed for use in medical, life-saving, or life-sustaining applications or for any other application in which the failure of the Vishay product could result in personal injury or death. Customers using or selling Vishay products not expressly indicated for use in such applications do so at their own risk. Please contact authorized Vishay personnel to obtain written terms and conditions regarding products designed for such applications.

No license, express or implied, by estoppel or otherwise, to any intellectual property rights is granted by this document or by any conduct of Vishay. Product names and markings noted herein may be trademarks of their respective owners.



EMI SAFETY CAPACITOR SOLUTIONS

FILM AND CERAMIC

CLASS X

Differential Mode Filtering
Across the Line

Sub class	Peak Impulse Voltage	Typical Application
X1	4.0 kV	High Pulse
X2	2.5 kV	General Purpose

CLASS Y

Common Mode Filtering
Line to Ground

Sub class	Peak Impulse Voltage	Typical Application
Y1	8.0 kV	High Pulse
Y2	5.0 kV	General Purpose

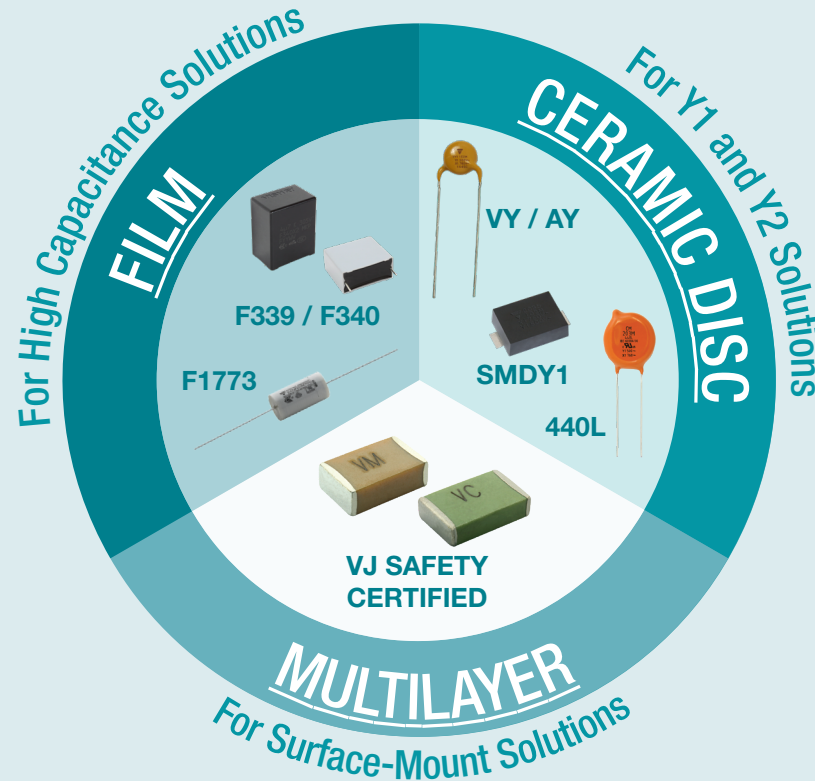

Safety Capacitor Map

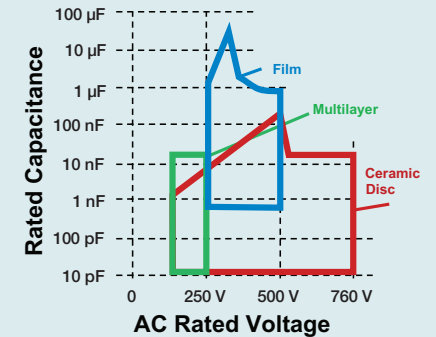

Typical Circuit

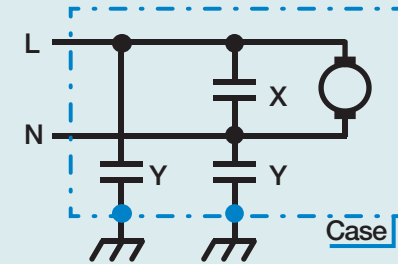

Technology	Rating	Series	Capacitance	Certificates	Special Features
Ceramic Disc	X1 / Y1	SMDY1	470 pF to 4700 pF	IEC, UL, CSA, and CQC	Industry-first 500 V _{AC} SMD type Y1 safety capacitor available
	X1 / Y1	VY1 , VY1C , AY1 , WKP , 440L	10 pF to 20 nF	IEC, UL, CSA, and CQC	Industry-first 20 nF, 85 °C / 85 % RH 1000 h available. AEC-Q200 available
	X1 / Y2	VY2 , AY2 , WYO	10 pF to 12 nF	IEC, UL, CSA, and CQC	AEC-Q200 available
MLCC	X1 / Y2	VJ Safety Certified Capacitors	10 pF to 1000 pF	IEC, cCSA	1 nF in X1 / Y2 with COG (NP0) Meets IEC 60384-14 min. 4 mm creepage, AEC-Q200 available
	X2		10 pF to 470 pF	IEC, cCSA	Meets IEC 60384-14 min. 4 mm creepage, AEC-Q200 available
	X1 / Y2		100 pF to 4700 pF	IEC, cCSA	Meets IEC 60384-14 min. 4 mm creepage, AEC-Q200 available
	X2		100 pF to 12 nF	IEC, cCSA	Meets IEC 60384-14 min. 4 mm creepage, AEC-Q200 available
Film	X1	F340X1 , F339X1 , and MKP3381	0.001 μF to 2.2 μF	IEC, UL, CSA, and CQC	THB Class IIIB available
	X2	F340X2 , F339X2 , and F1773	0.001 μF to 40 μF	IEC, UL, CSA, and CQC	THB Class IIB, IIIB, and AEC-Q200 available
	Y2	F340Y2 , MKP3386Y2	0.001 μF to 0.47 μF	IEC, UL, and CSA	THB Class IIIB and AEC-Q available

For a full overview of RFI capacitors, please visit www.vishay.com/doc?48140