

## Reference Design 48 V, 100 A eFuse



### LINKS TO ADDITIONAL RESOURCES

- [eFuse-48V100A reference design](#)

### DESCRIPTION

With the steady increase in 48 V eMobility applications, semiconductor-based resettable fuses are quickly replacing mechanical relays and contactors, as well as traditional non-resettable fuses. The eFuse concept is an innovative new trend for protecting both the user and the hardware in high power applications. In a new reference design by Vishay, an eFuse featuring TrenchFET<sup>®</sup> MOSFETs was designed to handle continuous current up to 100 A. It has been designed to operate continuously at max. current with less than 14 W of losses, without requiring active cooling. The design features a pre-charge function, continuous current monitoring, and overcurrent protection. The overcurrent protection can stop current flow through the eFuse in under 2  $\mu$ s.

The Vishay eFuse has been designed to safely connect and disconnect a 48 V power source (typically a high energy battery pack) to any type of vehicle load using TrenchFet<sup>®</sup> Gen IV power MOSFETs as the primary switches, which can operate at up to 100 A continuously.

### FEATURES

- Fast disconnect of loads in under 2  $\mu$ s
- Pre-charge of DC-Link capacitors of power electronics
- Resettable fuse
- Adjustable current limit

### KEY COMPONENTS

- [SQJQ184E MOSFET](#)
- [WSLP3921 100  \$\mu\$ Ω Shunt](#)
- [D2TO35 10  \$\Omega\$  Pre-Charge Resistor](#)
- [MMU 0102 1  \$\Omega\$  Gate Resistor](#)
- [VOMA617A Optocoupler](#)

### APPLICATIONS

- Battery management systems
- EV test environments
- Solar installations
- Industry and home automation
- Industrial and server computing
- Networking, telecom, and base station power supplies

### TYPICAL APPLICATION CIRCUIT

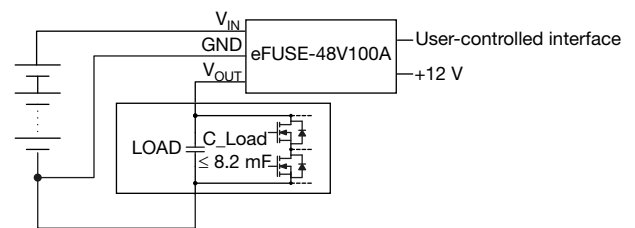

**PIN CONFIGURATION**

The 24 V or 48 V battery or power source must be connected to the  $V_{IN}$  cable and the load to the  $V_{OUT}$  cable. The GND cable serves as a reference point for the voltage measurement as well as a discharge path for voltages exceeding the specification. Furthermore, when the power is turned off, the current in inductive loads is discharged through the flyback diodes via the GND cable.

It must be ensured that the discharge path is through the GND cable and not through the GND pins on ST1 or ST2. Due to the internal connection of all GNDs, an isolated power supply must be used at ST2, or if the logic power supply has the same ground as the power source at  $V_{IN}$ , the GND pins must not be connected to ST2.

This power connection is placed in the back panel with black 16 mm<sup>2</sup> cables and ring terminals for M8 screws for  $V_{IN}$  and  $V_{OUT}$ . The GND is a blue 4 mm<sup>2</sup> cable with an M4 ring terminal. All three cables are at least 300 mm in length.

PIN DESCRIPTION		
PIN NUMBER	SYMBOL	DESCRIPTION
1	$V_{IN}$	Voltage input: connect to positive battery / power supply terminal
2	GND	Connect to negative battery / power supply terminal and load terminal
3	$V_{OUT}$	Voltage output: connect to positive load terminal

**ST1 CONNECTOR**

The ST1 connector allows for control of the eFuse via an optional controller. If pin 3 I\_LIM\_SW is high (3.3 V), the internal I<sup>2</sup>C DAC (MCP4725A2T-E/CH) is used instead of the rotary switch to set the current limit. The 16-bit I<sup>2</sup>C bus I/O expander (PI4IOE5V6416Q2LEX) is used to control the eFuse and read the state back. In addition, there is an I<sup>2</sup>C EEPROM (BR24T04NUX-WTR) that stores the serial number and the configuration for the user controlled interface. A 16-bit SPI ADC (ADS88671DGSR) is used with an 8-channel multiplexer (DQG4051EEQ-T1-GE4) to measure the input voltage, output voltage, current, temperature, I\_LIM\_INT, and I\_LIM\_EXT.

PIN DESCRIPTION		
PIN NUMBER	SYMBOL	DESCRIPTION
1	+5 V	+5 V power supply delivered from the eFuse
2	+5 V	+5 V power supply delivered from the eFuse
3	I_LIM_SW	If pulled up, the current limit is used from the I <sup>2</sup> C DAC
4	nc	Not connected
5	+3.3 V	+3.3 V must be provided for the EEPROM and ADC
6	nc	Not connected
7	I2C_SCL	I <sup>2</sup> C serial clock line
8	I2C_SDA	I <sup>2</sup> C serial data line
9	SPI_SCLK	SPI serial clock
10	SPI_CS	SPI slave select of the ADC (active low)
11	SPI_MISO	SPI master in, slave out
12	SPI_MOSI	SPI master in, slave in
13	GND	Ground. It is internally connected to the GND cable and GND ST2
14	GND	Ground. It is internally connected to the GND cable and GND ST2

**ST2 LOGIC POWER CONNECTOR**

It must be ensured that the discharge path is through the GND cable and not through the GND pins on ST1 or ST2. Due to the internal connection of all GNDs, an isolated power supply must be used at ST2, or if the logic power supply has the same ground as the power source at V<sub>IN</sub>, the GND pins must not be connected to ST2.

PIN DESCRIPTION		
PIN NUMBER	SYMBOL	DESCRIPTION
1	GND	Ground for logic power input. It is internally connected with the GND cable and GND ST1
2	+12 V	0 V to +30 V DC logic power input
3	GND	Ground for logic power input. It is internally connected with the GND cable and GND ST1

FUNCTIONAL RATINGS (T <sub>A</sub> = 25 °C, unless otherwise noted)					
PARAMETER	SYMBOL	MIN.	TYP.	MAX.	UNIT
Battery voltage	V <sub>IN</sub>	10	48	56	V
Logic power voltage (pin 2 ST2)	+12 V	10	12	30	V
Logic power current (pin 2 ST2)	+12 V	30	60	250	mA
Load input capacity		0	-	10	mF

ABSOLUTE MAXIMUM RATINGS (T <sub>A</sub> = 25 °C, unless otherwise noted)		
ELECTRICAL PARAMETER	LIMITS	UNIT
V <sub>IN</sub> , V <sub>OUT</sub>	0 to +60	V
Logic power voltage +12 V (pin 2 ST2)	0 to +40	V
Ambient temperature	-40 to +50	°C
Storage temperature	-40 to +50	°C
Power dissipation	14	W

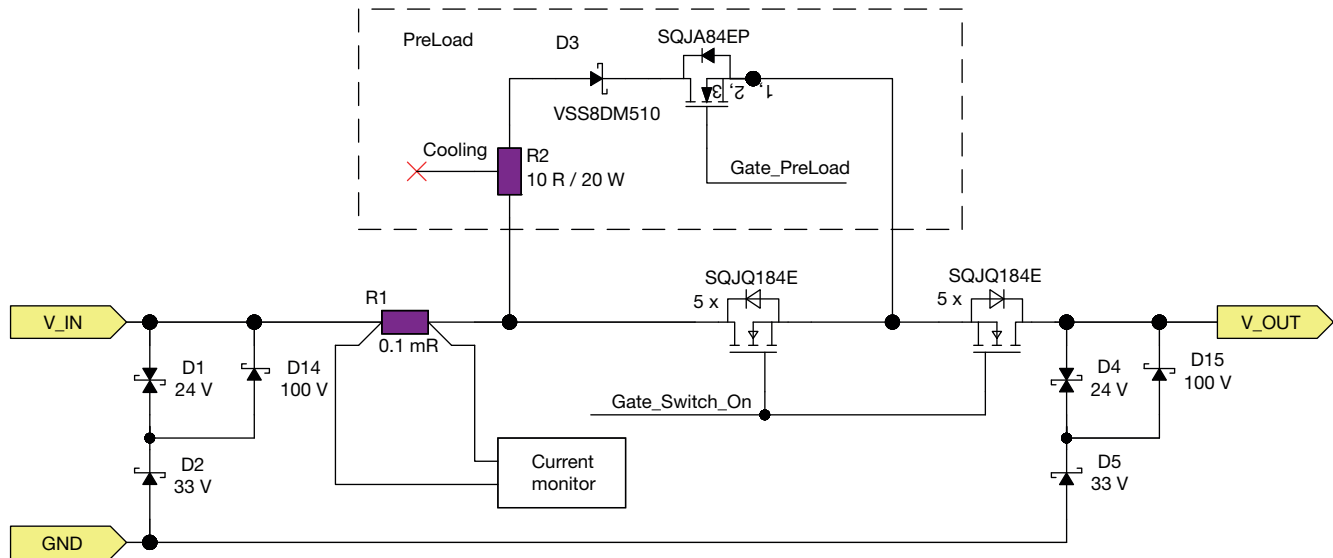
**PRINCIPLE DIAGRAM**

**OPERATIONAL DESCRIPTION**

The eFuse must be able to switch currents that are flowing in either direction. Therefore, two sets of five parallel connected MOSFETs are arranged in a back to back configuration. The load current is measured using a Vishay WSLP3921 current sensing shunt resistor located between  $V_{IN}$  and the anti-serial MOSFETs.

The pre-charge function is carried out by a single MOSFET (TR11) in series with a thick film resistor (R2). Note, that there is no pre-charge function for currents flowing from  $V_{OUT}$  to  $V_{IN}$ .

If the current exceeds a pre-determined limit the load is quickly disconnected from the battery pack to protect both the battery pack and the user. The eFuse can also detect excessive load capacitance or a short circuit during power-up and immediately shut down.

The eFuse is constructed using a standard double-sided four-layer PCB (FR4) with 70  $\mu\text{m}$  (2 oz.) of copper on each layer. The overall dimensions of the PCB are 144 mm  $\times$  60 mm. A second two-layer PCB is used for the front panel.

The power circuitry (10  $\times$  SQJQ184E 80 V MOSFETs) is located in the upper part of the PCB and the control circuitry with logic ICs, amplifiers, and ADCs is located in the lower part. The connectors, control buttons, status LEDs, and the rotary switch are located on the front-panel PCB. With the addition of the user-controlled interface software, the eFuse can be operated via a web browser.

The heat generated by the MOSFETs is transferred via thermal vias to a solid copper layer on the bottom of the layer stack and further to the housing, which acts as a heat-sink.

$V_{IN}$  and  $V_{OUT}$  are both equipped with transient voltage suppressors to GND. The combination of a XMC7K24CA and a 5KASMC33A voltage suppressor results in a stand-off voltage of 57 V and a breakdown voltage range between 63.4 V and 70.7 V at 25  $^{\circ}\text{C}$ . A VS-30BQ100 Schottky diode is connected in parallel to each bidirectional XMC7K24CA TVS diode and used as a flyback diode.

The logic section of the PCB must be supplied with +10 V to +30 V from an external voltage source connected to ST2 in the front panel. It requires approximately 60 mA of current at 12 V (170 mA to 210 mA if an external user-controlled interface is connected). The power supply on the PCB is protected against a reverse polarity connection. The logic and the 48 V power supply share the same GND.

**FRONT PANEL**

LED DESCRIPTION		
COLOR	LABEL	DESCRIPTION
Green	Ready	Power for the control logic is established
Yellow	PreL.	Pre-load function is active. A 10 $\Omega$ resistor is connected between <V_IN> and <V_OUT>
Green	On	Main MOSFETs are switched on. <V_IN> and <V_OUT> are connected
Red	CapL.	Output capacitance is too large. After pre-charging 250 ms, <V_OUT> is less than 85 % of <V_IN>
Red	Short	Short circuit is detected. After pre-charging 25 ms, <V_OUT> is less than 10 % of <V_IN>
Red	OCur.	Over current is detected. The output current exceeded the selected limit

**USER INTERFACE**

The Vishay eFuse can be activated / deactivated either via the ON / OFF buttons on the front panel or via an external controller. The current limit can be set manually using a rotary switch on the front panel, allowing the user to set a limit between 0 A and 99 A in steps of 11 A. It can be also set in 1 A resolution with the user-controlled interface software.

**MODE OF OPERATION**

The 10 MOSFETs are controlled by a gate driver to keep the switching times low, and the resulting current in the gate will be +4 A maximum for a short time during turn-on.

If an error occurs during operation of the eFuse, the load is disabled and the corresponding LED on the front panel is illuminated. The error is also displayed in the web interface when using the user-controlled interface software. The error must first be confirmed by pressing with the black “OFF” button on the front panel or the reset button on the web interface before the eFuse can be turned on again by the user.

**TURN-ON PROCEDURE**

The user can enable the eFuse by using either the red “ON” button on the front panel or the “Switch ON” button on the web interface. To prevent high inrush currents during turn-on, the eFuse employs a two-stage pre-charge function:

1. The eFuse is enabled
2. The eFuse checks for excessive current in the load circuit (short circuit condition)
3. The eFuse checks for excessive capacitance in the load circuit to prevent a high in-rush current from the battery
4. If both stages of the pre-charge have been completed successfully, the load is energized by switching on the main MOSFETs

### FIRST STAGE OF THE PRE-CHARGE / SHORT CIRCUIT PROTECTION

During the first stage of the pre-charge, a resistor (10  $\Omega$ , 20 W) is connected in series between  $V_{IN}$  and  $V_{OUT}$ . After 25 ms, the output voltage is measured to see if it exceeds 10 % of the input voltage. If the output voltage remains close to 0 V, a short circuit condition exists in the load, the pre-charge stage is terminated, the error “Fail Pre-charge Short” is displayed in the web app, and the LED “Short” is lit. During this first stage of the pre-charge, a maximum of 360 W is generated within the resistor, which is permissible for the short period of time.

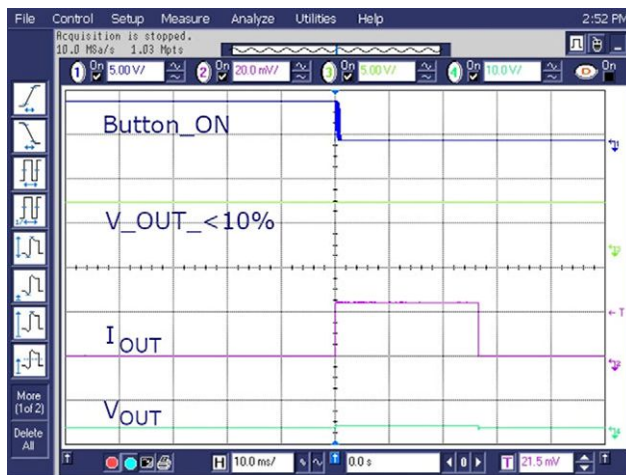
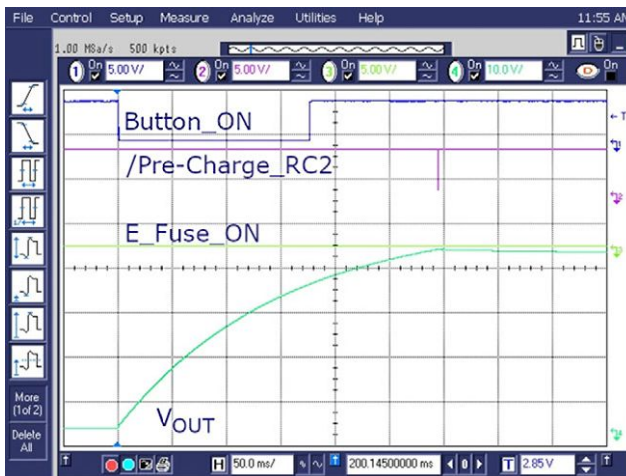

**Fig. 1 - Short Circuit Protection while Pre-Charging**

In Fig. 1, the output of the eFuse is shorted. The output voltage  $V_{OUT}$  increases marginally after the system is enabled so the logic signal  $V_{OUT} < 10\%$  stays high for the entire 25 ms period, and therefore, the pre-charge is terminated. The output current  $I_{OUT}$  was limited due to the pre-charge resistor to 2.2 A at 24 V  $V_{IN}$ .

### SECOND STAGE OF THE PRE-CHARGE

If the first stage is successful, the pre-charge will be extended. In the second stage, the output voltage is measured after approximately 300 ms to determine whether it has risen to at least 85 % of the input voltage. If the total capacitance of the load is excessive, the output voltage will not rise sufficiently, the pre-charge will be terminated, and the error “Fail Pre-charge Cap” is displayed via the web app or the red LED labeled “Cap.L.”.



**Fig. 2 - Switch-On Procedure Aborts During the Second Stage of Pre-Charge**

In Fig. 2, the eFuse is operated with 16.8 mF connected to the output. The output voltage  $V_{OUT}$  rises very slowly and does not reach the 85 % threshold after 300 ms. Therefore, the logic signal  $V_{OUT} < 85\%$  stays high for the entire duration, and the pre-charge is terminated.

The allowed output capacitance is approximately 10 mF and is determined by the value of the pre-charge resistor and the time allowance for this pre-charge.

**TURN-ON AFTER SUCCESSFUL PRE-CHARGE**

If both pre-charge stages have been completed successfully, the main MOSFETs are switched-on using the gate driver, which takes turns on approximately 1  $\mu$ s followed by the logical signal E\_Fuse\_ON going high.

Fig. 3 shows a switch-on process after successful pre-charging with a 10 mF capacitor connected to the output.

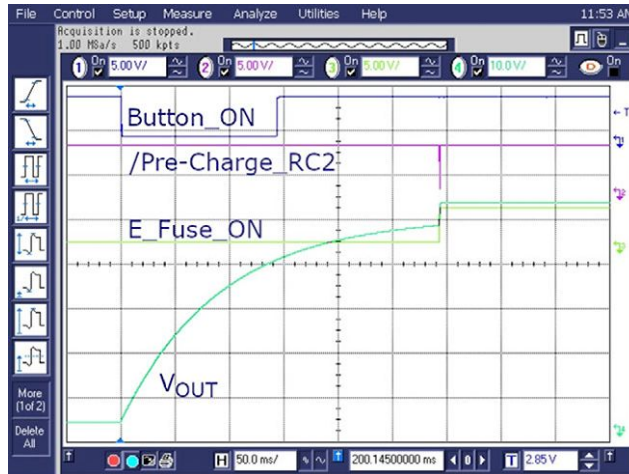

Fig. 3 - Successful Switch-On Procedure, 10 mF DC-Link Capacitor

**TURN-OFF PROCEDURE**

The eFuse can be turned-off for various reasons:

- The user presses the black “OFF” button in the front panel
- The user uses the “Switch OFF” button in the web interface
- The adjustable current limit threshold is exceeded for over 300  $\mu$ s (indicated by “Fail Over Current” in the web app and the red LED “OCur.” on the front panel)
- The adjustable current limit threshold is substantially exceeded, e. g. if shorted. Indicated by “Fail M-Over Current” in the web app

## STANDARD TURN-OFF PROCEDURE

When the eFuse is disabled (either by the user or due to an overcurrent situation) the MOSFET driver discharges the gates in under 1  $\mu\text{s}$ .

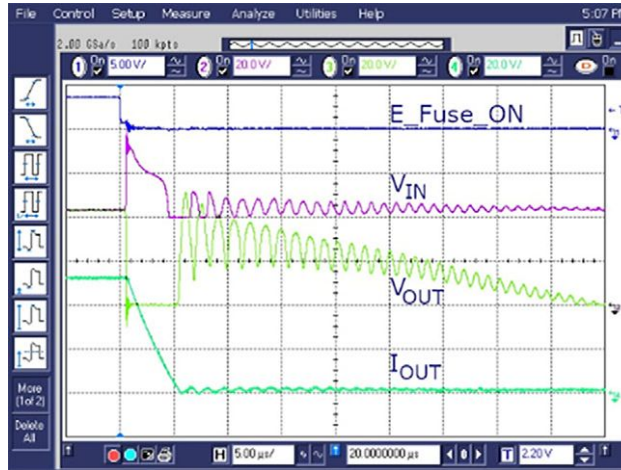

**Fig. 4 - Switch-Off Procedure of the eFuse with 50 A and 42 V**

In Fig. 4 the eFuse is turned off manually. The MOSFET turns off within the first 1  $\mu\text{s}$ . To dissipate the energy stored in the cable and filter inductance, the output freewheeling diode and input TVS conduct between 1  $\mu\text{s}$  and 5  $\mu\text{s}$ . After 5  $\mu\text{s}$  the energy is dissipated and the circuit returns into a steady state.

After the current decreases to zero the output voltages can go up to the previous value due to the charge of the input capacitor of the load, as shown in Fig. 4.  $V_{\text{OUT}}$  is then slowly discharged, for example by a bleed resistor or the load itself. While at higher currents in this test setup the output voltage  $V_{\text{OUT}}$  just slightly increases, as shown in Fig. 5. For the test setup in Fig. 4 and Fig. 5, a power supply and electronic load is used. The behavior may change depending on the test setup and hardware. The rapid turn-off of the main MOSFETs and change of conduction state can cause ringing in both input and output due to the energy flowing between the inductance and the capacitance of the respective side. The depicted rise of the input voltage is caused by the cable inductance, and perhaps the power supply not reacting fast enough to the load dump. The TVS clamping diodes prevent the input voltage from exceeding the 80 V  $V_{\text{DS}}$  rating of the MOSFETs.

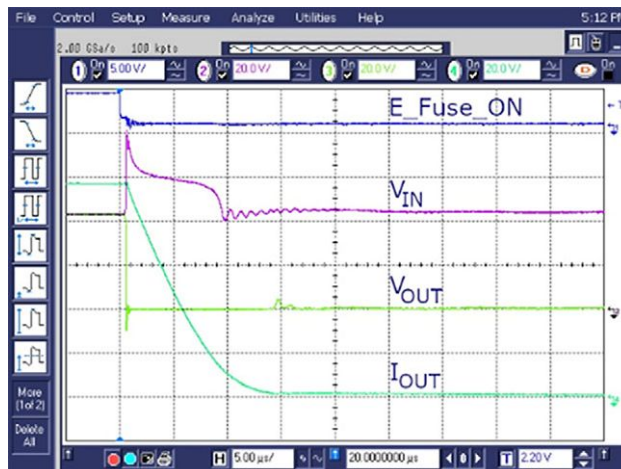

**Fig. 5 - Switch-Off Procedure of the eFuse with 100 A and 42 V**



## TURN-OFF PROCEDURE AFTER A SHORT CURCUIT CONDITION

In addition to the adjustable current limit, another limit of 160 A has been hardcoded into the eFuse. If the load current exceeds this limit, the eFuse is immediately turned off to protect the power supply. Afterwards, an error “Fail M-Over current” is displayed in the web app.

## POWER DISSIPATION

The following components contribute to the total resistance of the eFuse at 25 °C:

- The on-resistance of the MOSFETs:  $2 \times 1.4 \text{ m}\Omega / 5 = 0.56 \text{ m}\Omega$
- The shunt resistor for measuring the current:  $0.1 \text{ m}\Omega$
- The parasitic resistances of copper traces and connectors:  $0.6 \text{ m}\Omega$

Therefore, the total on-resistance is approximately  $1.3 \text{ m}\Omega$ , equating to  $12.7 \text{ W}$  of conduction losses at  $99 \text{ A}$  of load current. With the increasing temperature of the components, the losses increase to approximately  $13.5 \text{ W}$  after 30 minutes at  $99 \text{ A}$ .

## THERMAL OPERATION

The integrated temperature sensor can be monitored at any time using the web interface. The sensor is located between two of the MOSFETs, so it may display a lower temperature than the actual highest temperature on the PCB. The actual temperatures on the PCB were captured using a thermal imaging camera, as shown in Fig. 6 and Fig. 7.

## THERMOGRAPHIC IMAGES

The eFuse is operated with various continuous load currents up to  $99 \text{ A}$  for 30 minutes only with the attached heat-sink for passive cooling, and are conducted with an ambient temperature of  $25 \text{ }^\circ\text{C}$ . The resulting temperature increase is monitored using a thermal imaging camera. The results are shown in Fig. 6 and Fig. 7. Even with a  $99 \text{ A}$  load current the maximum temperature never exceeded  $70 \text{ }^\circ\text{C}$ .

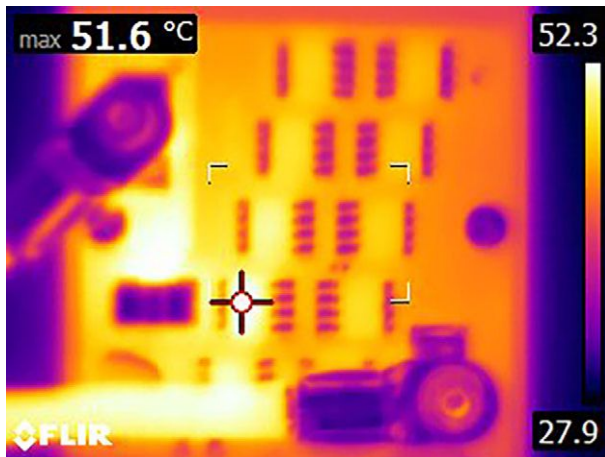

Fig. 6 - Stress Test with 99 A Load After 5 Minutes

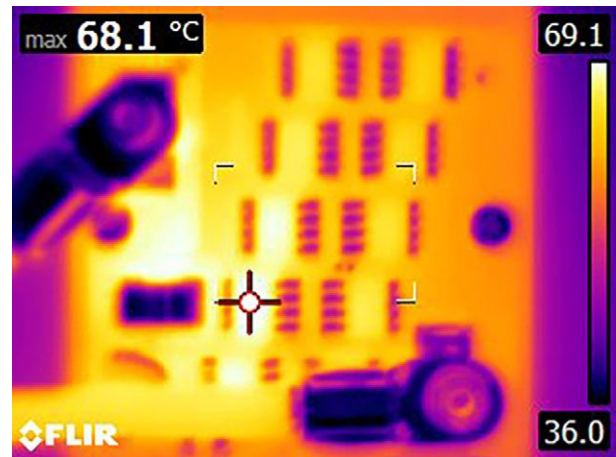

Fig. 7 - Stress Test with 99 A After 30 Minutes



## Disclaimer

1. Vishay Intertechnology, Inc. and its affiliates (“**Vishay**”) provides the reference design to which this disclaimer is attached (the “**reference design**”), and may provide certain products, parts and components to implement the reference design (each, an “**evaluation kit**”), solely to assist customers and potential customers (each, a “**user**”) who, in a research and development setting, are developing products and applications that incorporate Vishay products. This disclaimer supplements the terms of and conditions under which the user gains access to the reference design and / or evaluation kit (the “**terms and conditions**”). If and to the extent this disclaimer conflicts with the terms and conditions, this disclaimer will control.
2. Vishay and their respective directors, officers, agents, and employees (collectively, the “**Vishay parties**”), disclaim any and all warranties concerning the reference design or evaluation kits, and all liability for any errors, inaccuracies, incompleteness or other defects in the reference design or evaluation kits. Without limiting the foregoing:
  - 2.1. Users are responsible for (a) using their independent analysis, evaluation and judgment to validate the operating parameters, including typical parameters, for each component specified by the reference design or included in an evaluation kit, (b) assuring the safety of the products they develop and the compliance of those products with all applicable regulations, laws and other applicable requirements, and (c) obtaining any licenses to third party intellectual property rights that may be necessary for their products.
  - 2.2. Vishay makes no warranty, representation, or guarantee regarding the suitability of the reference design or evaluation kits for any particular purpose. To the maximum extent permitted by applicable law, Vishay disclaims (i) any and all liability arising out of the application or use of any design or product, (ii) any and all liability, including without limitation special, consequential, or incidental damages, and (iii) any and all implied warranties, including warranties of fitness for particular purpose, non-infringement, and merchantability. The aggregate liability of all Vishay parties will not exceed the amount the Vishay parties received in exchange for the reference design or evaluation kit giving rise to the claim.
  - 2.3. Users acknowledge that (i) the reference design was created under laboratory conditions, and no Vishay party has conducted any testing other than as may be specifically described in the reference design, (ii) any information in the reference design related to third party components described by a reference design or included in an evaluation kit (“**third party products**”) does not constitute a license to use any third party product, or a warranty or endorsement of any third party product, and use of any such information, products or services may require a license from a third party under patents or other intellectual property rights and (iii) Vishay may make corrections, enhancements, improvements and other changes to their respective products and services, reference design, or evaluation kit, and to discontinue any product or service. Vishay has no obligations and makes no claims, representations, warranties, or guarantees regarding third party products included in a reference design or evaluation kit.
  - 2.4. Statements regarding the suitability of the reference design, evaluation kit, or other Vishay product for certain types of applications are based on Vishay’s knowledge of typical requirements often placed on Vishay products in generic applications. Such statements are not binding statements about the suitability of the reference design, evaluation kit, or other Vishay product for a particular application. It is the customer’s responsibility to validate that a particular reference design, evaluation kit, or other Vishay product with the properties described in the reference design or included in the evaluation kit is suitable for a particular application.
  - 2.5. The reference design is not fault-tolerant and is not intended for high risk applications, including without limitation in the operation of nuclear facilities, aircraft navigation or control systems, air traffic control, life support machines, weapons systems, or any other application in which the failure of the reference design could lead to death, personal injury, or severe physical or environmental damages. Any use of the reference design in connection with high risk applications or any other applications is fully at the user’s own risk. Neither the evaluation kits nor their components are intended for commercial products or in consumer or household environments.
3. No license, express or implied, by estoppel or otherwise, to any intellectual property rights is granted by this document or by any conduct of Vishay. Product names and markings noted herein may be trademarks of their respective owners.
4. This disclaimer will be governed by the laws of the Commonwealth of Pennsylvania without reference to conflict of laws principles. User and the Vishay parties agree that the sole and exclusive jurisdiction for any dispute regarding the reference design or evaluation kits will be the state and federal courts sitting in Philadelphia, Pennsylvania.



## Disclaimer

ALL PRODUCT, PRODUCT SPECIFICATIONS AND DATA ARE SUBJECT TO CHANGE WITHOUT NOTICE TO IMPROVE RELIABILITY, FUNCTION OR DESIGN OR OTHERWISE.

Vishay Intertechnology, Inc., its affiliates, agents, and employees, and all persons acting on its or their behalf (collectively, "Vishay"), disclaim any and all liability for any errors, inaccuracies or incompleteness contained in any datasheet or in any other disclosure relating to any product.

Vishay makes no warranty, representation or guarantee regarding the suitability of the products for any particular purpose or the continuing production of any product. To the maximum extent permitted by applicable law, Vishay disclaims (i) any and all liability arising out of the application or use of any product, (ii) any and all liability, including without limitation special, consequential or incidental damages, and (iii) any and all implied warranties, including warranties of fitness for particular purpose, non-infringement and merchantability.

Statements regarding the suitability of products for certain types of applications are based on Vishay's knowledge of typical requirements that are often placed on Vishay products in generic applications. Such statements are not binding statements about the suitability of products for a particular application. It is the customer's responsibility to validate that a particular product with the properties described in the product specification is suitable for use in a particular application. Parameters provided in datasheets and / or specifications may vary in different applications and performance may vary over time. All operating parameters, including typical parameters, must be validated for each customer application by the customer's technical experts. Product specifications do not expand or otherwise modify Vishay's terms and conditions of purchase, including but not limited to the warranty expressed therein.

Hyperlinks included in this datasheet may direct users to third-party websites. These links are provided as a convenience and for informational purposes only. Inclusion of these hyperlinks does not constitute an endorsement or an approval by Vishay of any of the products, services or opinions of the corporation, organization or individual associated with the third-party website. Vishay disclaims any and all liability and bears no responsibility for the accuracy, legality or content of the third-party website or for that of subsequent links.

Except as expressly indicated in writing, Vishay products are not designed for use in medical, life-saving, or life-sustaining applications or for any other application in which the failure of the Vishay product could result in personal injury or death. Customers using or selling Vishay products not expressly indicated for use in such applications do so at their own risk. Please contact authorized Vishay personnel to obtain written terms and conditions regarding products designed for such applications.

No license, express or implied, by estoppel or otherwise, to any intellectual property rights is granted by this document or by any conduct of Vishay. Product names and markings noted herein may be trademarks of their respective owners.