



TAOGLAS®

Datasheet

Taoglas IP67 Wi-Fi 2.4/5.8/7.125GHz Terminal Antenna

Part No:
GW.52.A153

Description

IP67 Wi-Fi 2.4/5.8/7.125GHz Long Dipole Antenna RP-SMA(M) Hinged

Features:

- 2.4/5.8/7.1GHz Band Operation
- Wi-Fi 6/7 Compatible
- Weatherproof and Outdoor Use - IP67 Rating
- 5 dBi Gain
- High Efficiency
- Hinged RP-SMA (M) Connector
- Height: 203mm
- Diameter: 13mm
- RoHS & Reach Compliant

1.	Introduction	2
2.	Specification	3
3.	Antenna Characteristics	4
4.	Radiation Patterns	6
5.	Mechanical Drawing	25
6.	Packaging	26
<hr/>		
	Changelog	27

Taoglas makes no warranties based on the accuracy or completeness of the contents of this document and reserves the right to make changes to specifications and product descriptions at any time without notice. Taoglas reserves all rights to this document and the information contained herein. Reproduction, use or disclosure to third parties without express permission is strictly prohibited.



1. Introduction



The Taoglas GW.52 is a IP67, 2.4 & 5.8GHz Wi-Fi terminal mount dipole antenna. At just 203mm in height and 13mm in diameter, the robust IP67 PC+PBT enclosure can be mounted indoor or outdoor straight or at right angle to the device with its hinged RP-SMA(M) connector. It is ideal for applications such as Bluetooth, BLE, ZigBee, Wi-Fi 6 & 7 and Wireless LAN. The GW.52, designed for superior performance and reliability, has an omnidirectional radiation pattern and extremely high efficiency and gain on all Wi-Fi bands.

Typical applications include:

- Smart Home
- Gateways/Routers
- Connected Agriculture

The GW.52 has up to 5.44dBi Peak making it a cost-effective, high-performing choice for any indoor or outdoor application. Many module manufacturers specify peak gain limits for any antennas that are to be connected to that module. Those peak gain limits are based on free-space conditions. In practice, the peak gain of an antenna tested in free-space can degrade by at least 1 or 2dBi when installed. So ideally you should go for a slightly higher peak gain antenna than mentioned on the module specification to compensate for this effect.

This great product has an SMA (M) connector as standard and is an ideal solution for any device requiring reliable performance in a slim form factor. The innovative hinge design not only provides flexibility when mounting the antenna, but its weatherproof, IP67 rating, means it be used in outdoor locations where potential water ingress would prevent other terminal mount antennas from being used.

For further information, or support to test and integrate this product please contact your regional Taoglas customer support team.

2. Specification

Electrical			
Frequency (MHz)	2400~2500	4900~5850	5925~7125
Efficiency (%)			
Free space	47.8	88	81.8
15X9cm Ground plane	74.1	70.4	65.4
9X15cm Ground plane	74.4	67.2	57.8
Average Gain (dB)			
Free space	-3.21	-0.56	-0.90
15X9cm Ground plane	-1.30	-1.52	-1.80
9X15cm Ground plane	-1.29	-1.73	-2.28
Peak Gain (dBi)			
Free space	2.93	4.53	5.53
15X9cm Ground plane	5.16	3.83	4.10
9X15cm Ground plane	5.44	4.69	3.58
Impedance	50Ω		
Polarization	Linear		
Radiation Pattern	Omni		
Mechanical			
Height	203 ±3.3 mm		
Planner Dimension	Ø13 mm x 203		
Casing	PC+PBT		
Connector	RP-SMA(M)		
Environmental			
Temperature Range	-40°C to 85°C		
Humidity	Non-condensing 65°C 95% RH		

3. Antenna Characteristics

3.1 Return Loss

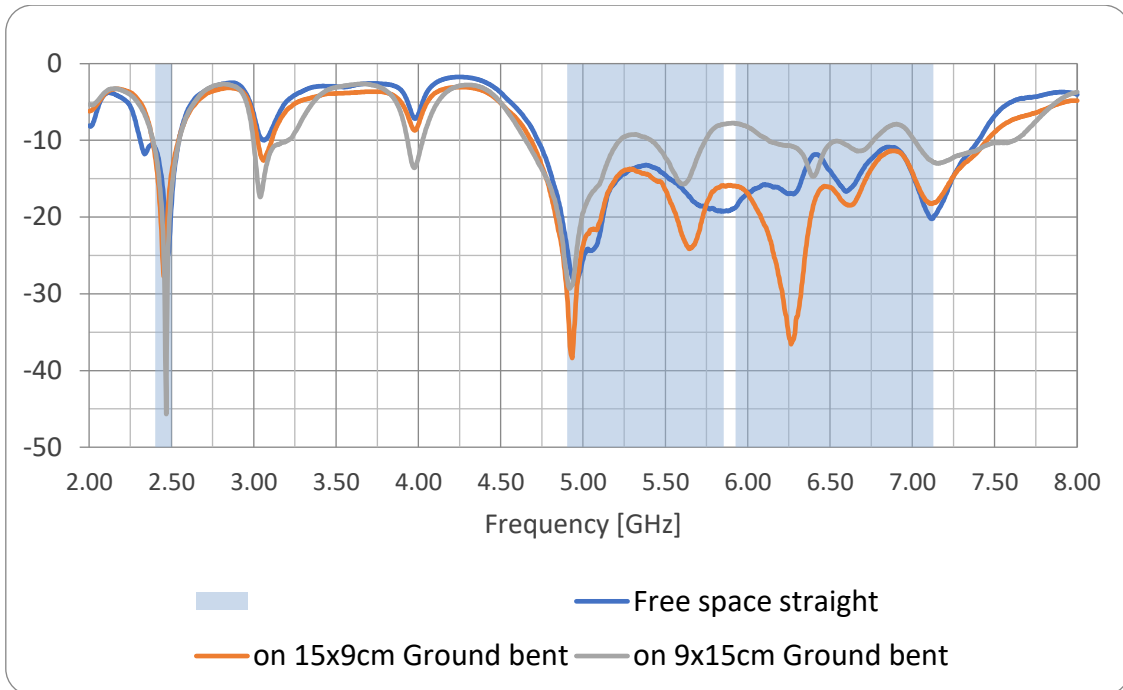

3.2 Efficiency

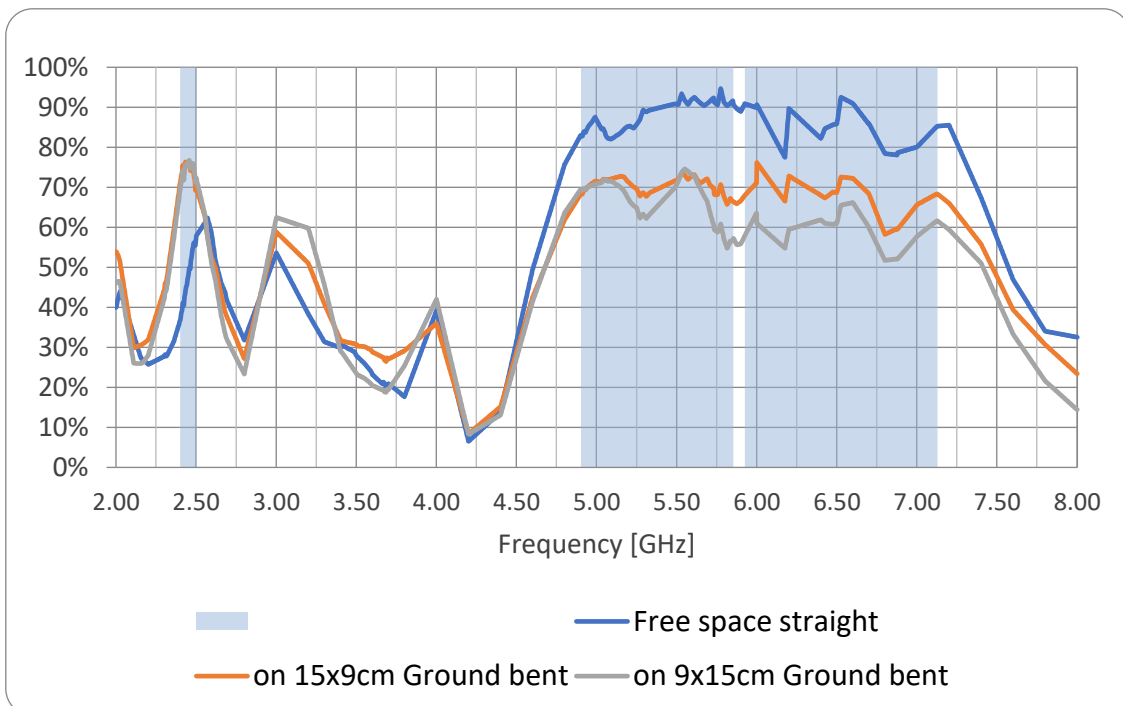

3.3 Average Gain

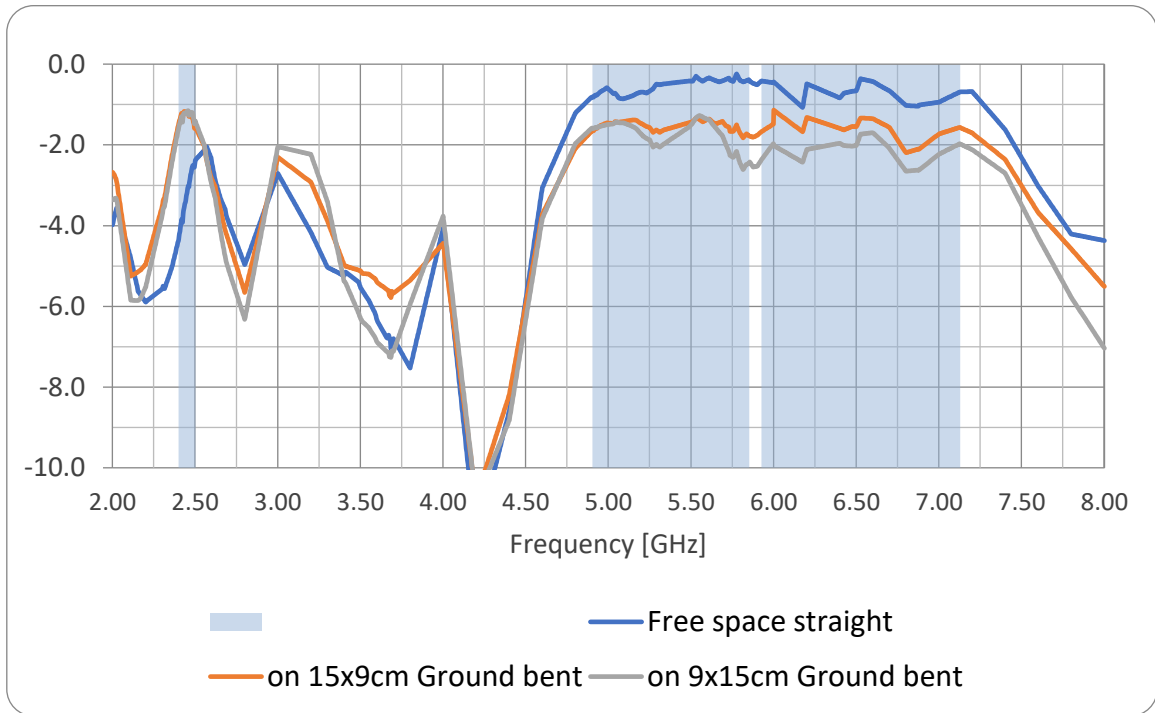

3.4 Peak Gain

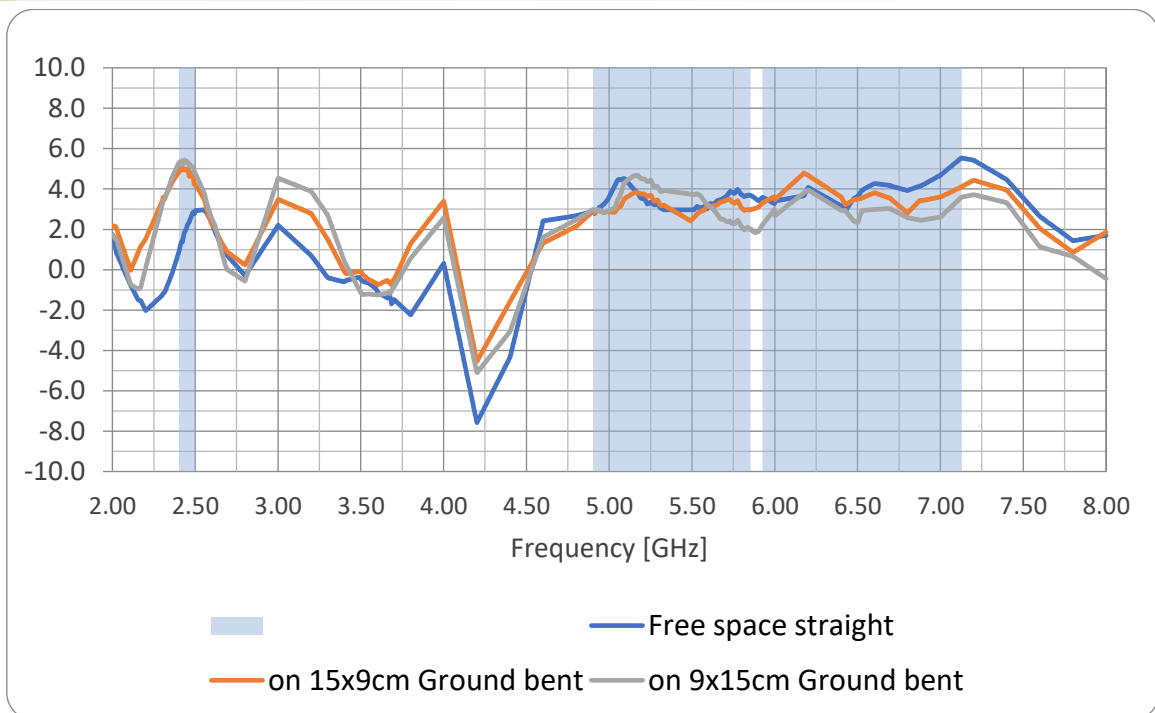

4. Radiation Patterns

4.1 Test Setup

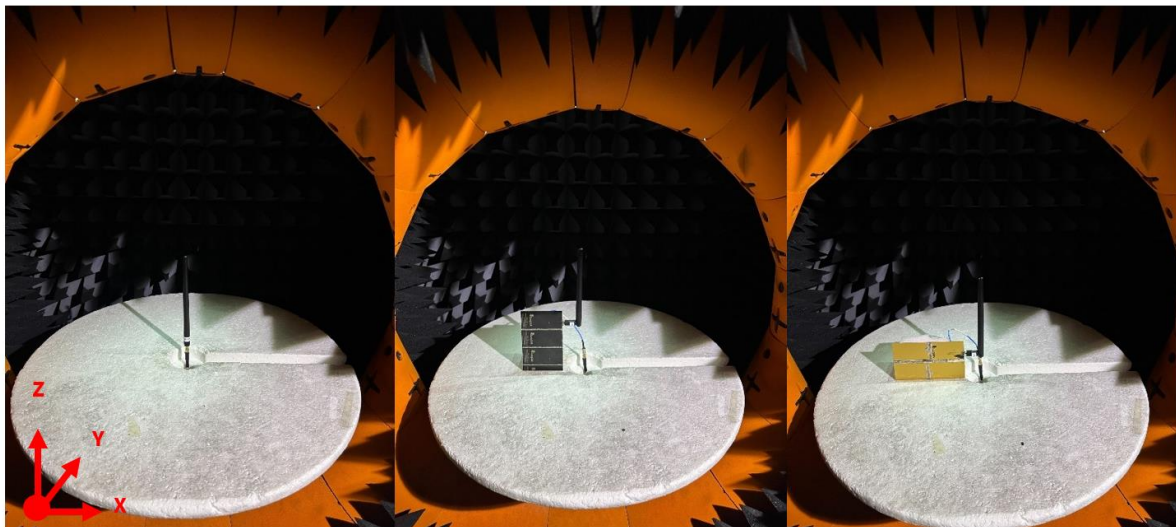
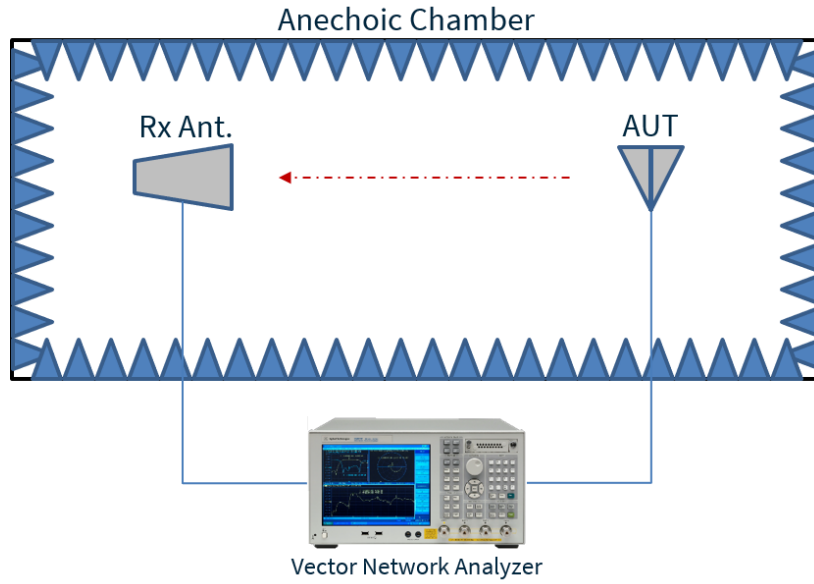

Free space

On 15x9cm Ground

On 9x15cm Ground

4.2 Free space 3D and 2D Radiation Patterns at 2450 MHz

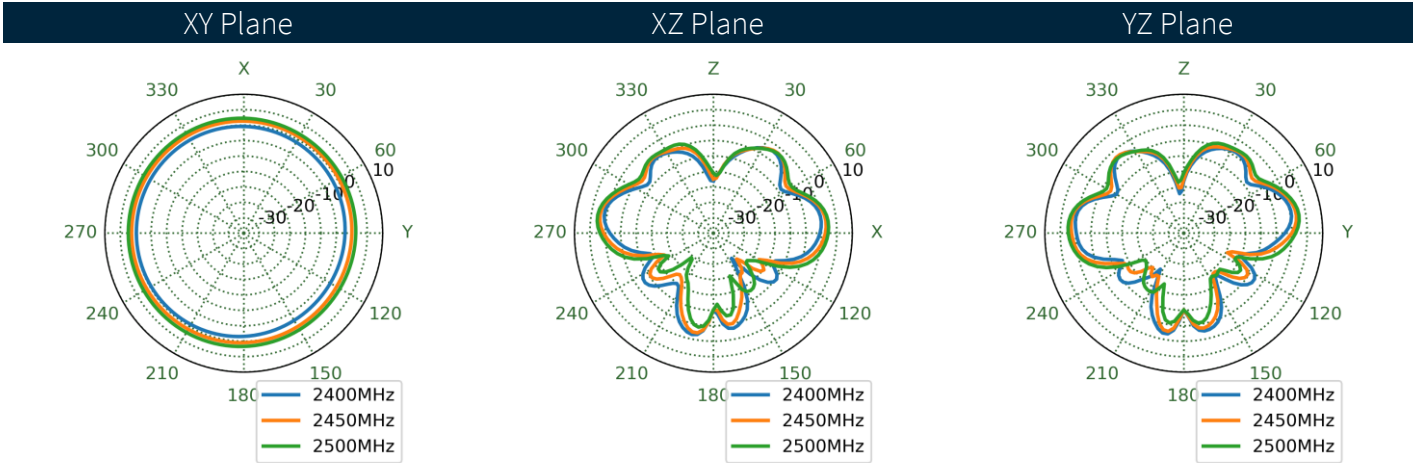
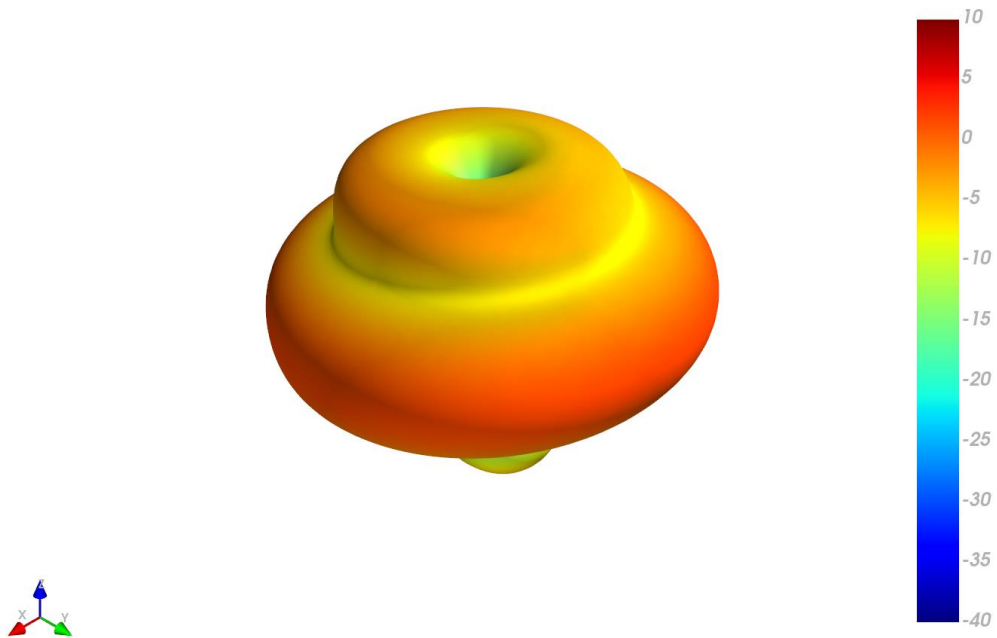

4.3 Free space 3D and 2D Radiation Patterns at 5550 MHz

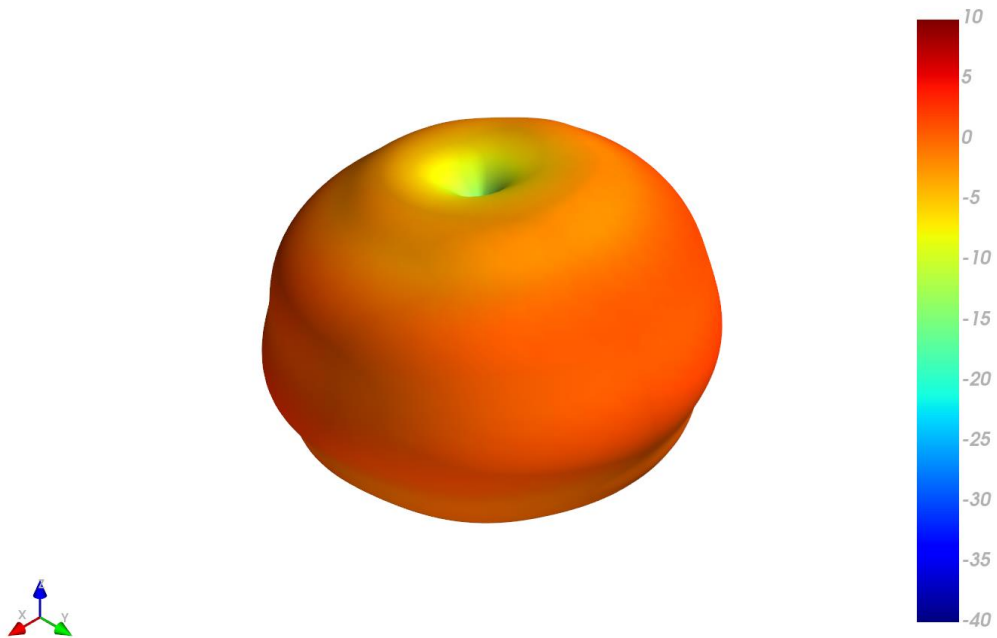

XY Plane XZ Plane YZ Plane

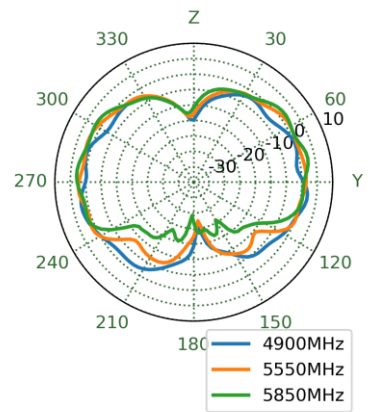
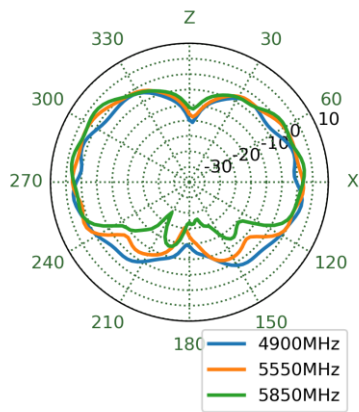
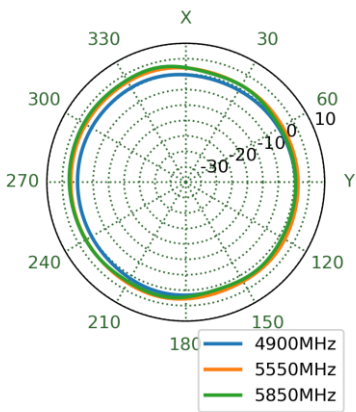

4.4 Free space 3D and 2D Radiation Patterns at 6175 MHz

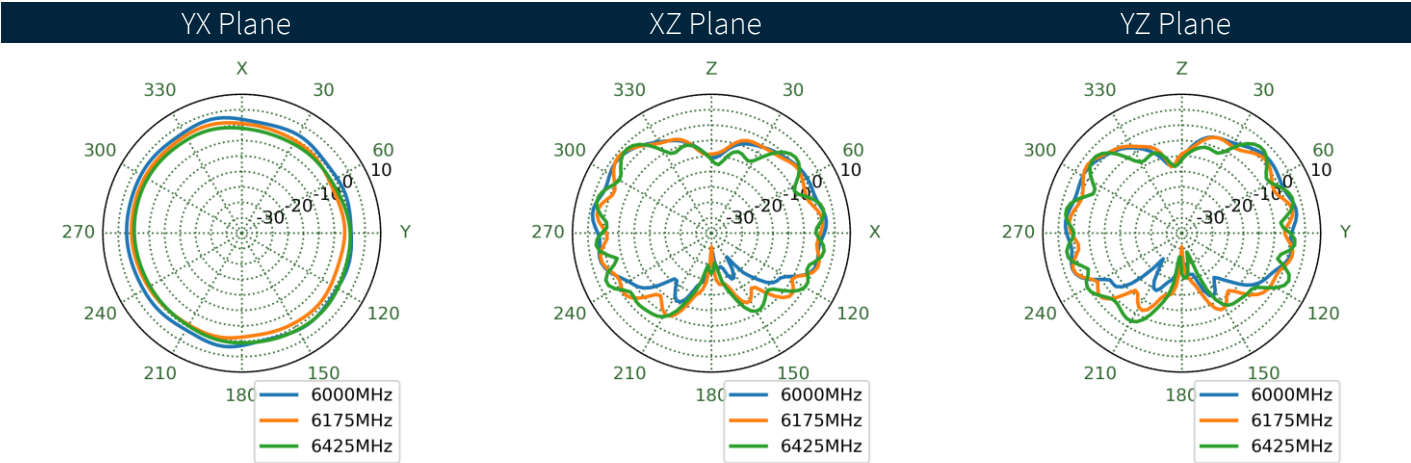
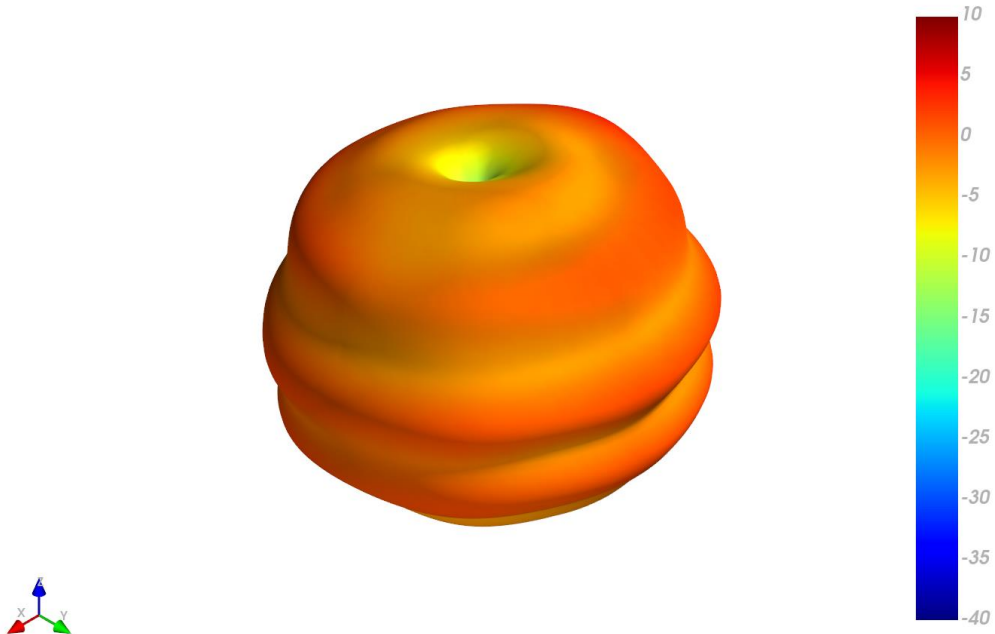

4.5 Free space 3D and 2D Radiation Patterns at 6475 MHz

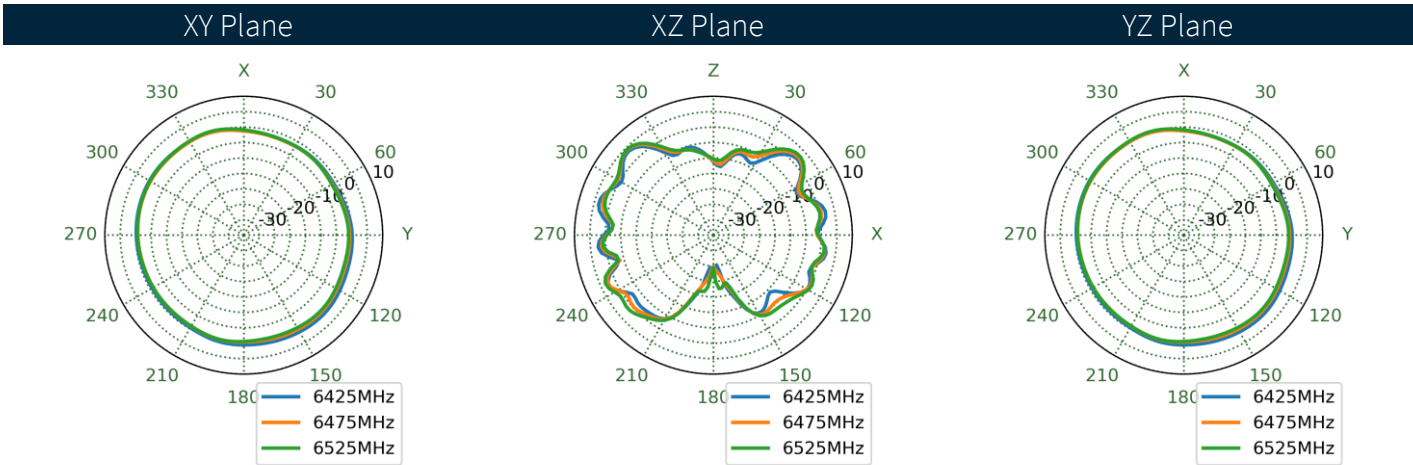
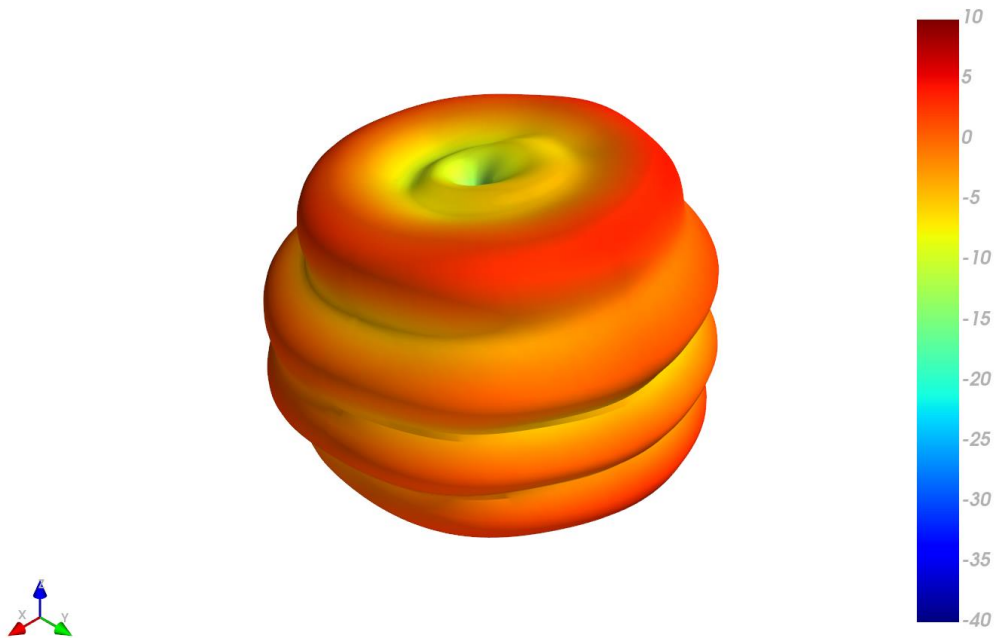

4.6 Free space 3D and 2D Radiation Patterns at 6700 MHz

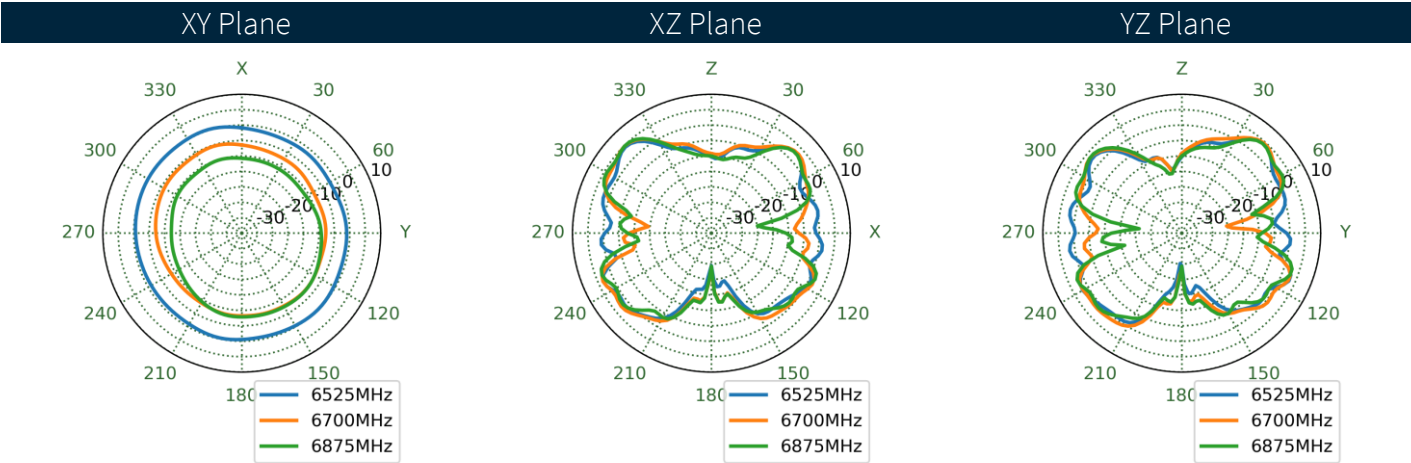
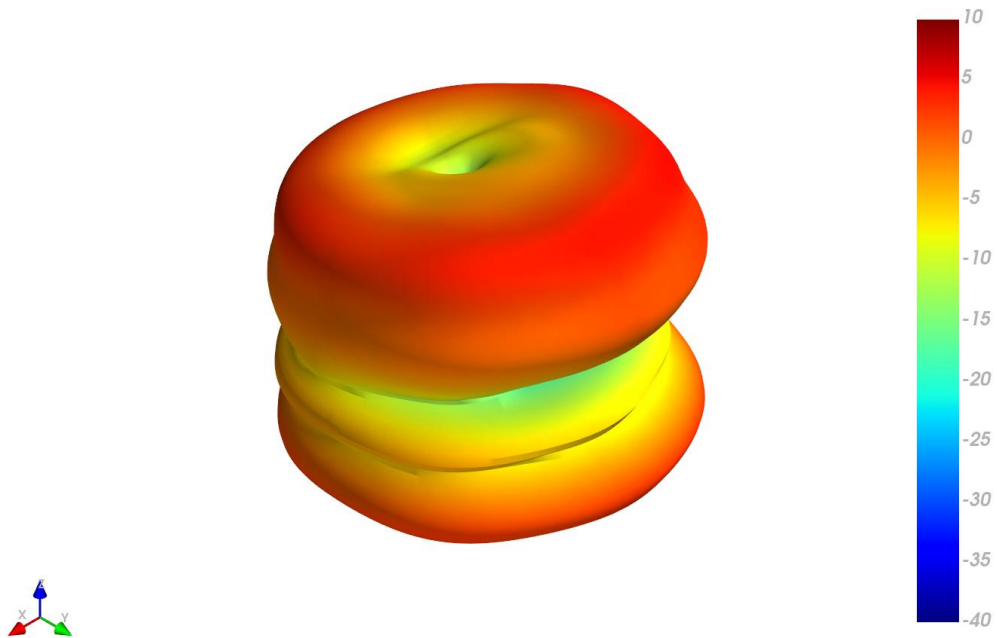

4.7 Free space 3D and 2D Radiation Patterns at 7000 MHz

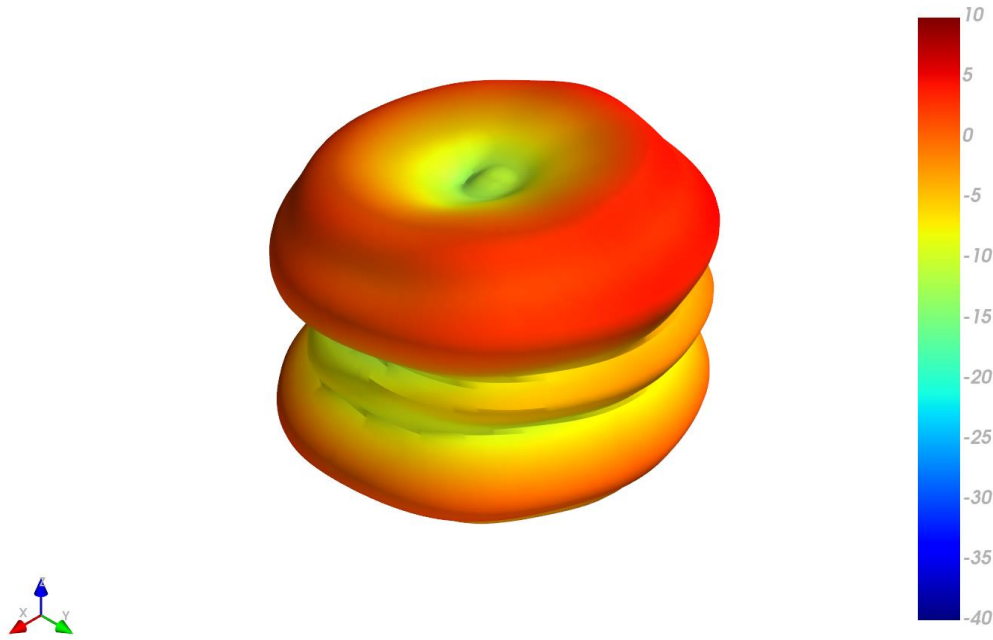

XY Plane XZ Plane YZ Plane

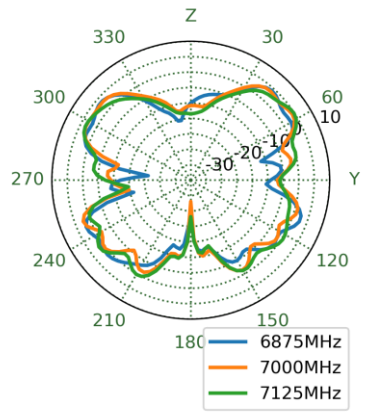
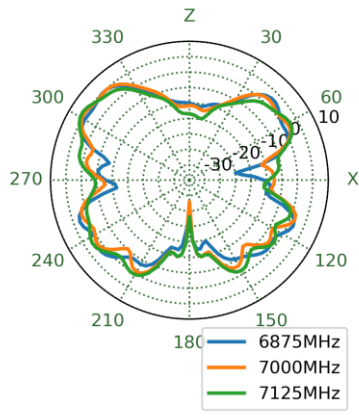
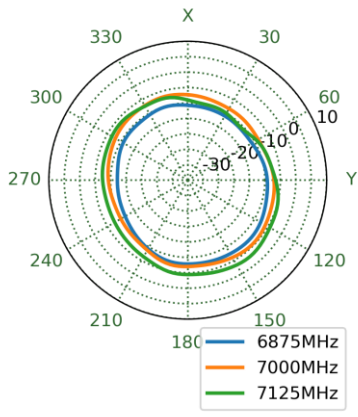

4.8 15x9cm Ground 3D and 2D Radiation Patterns at 2450 MHz

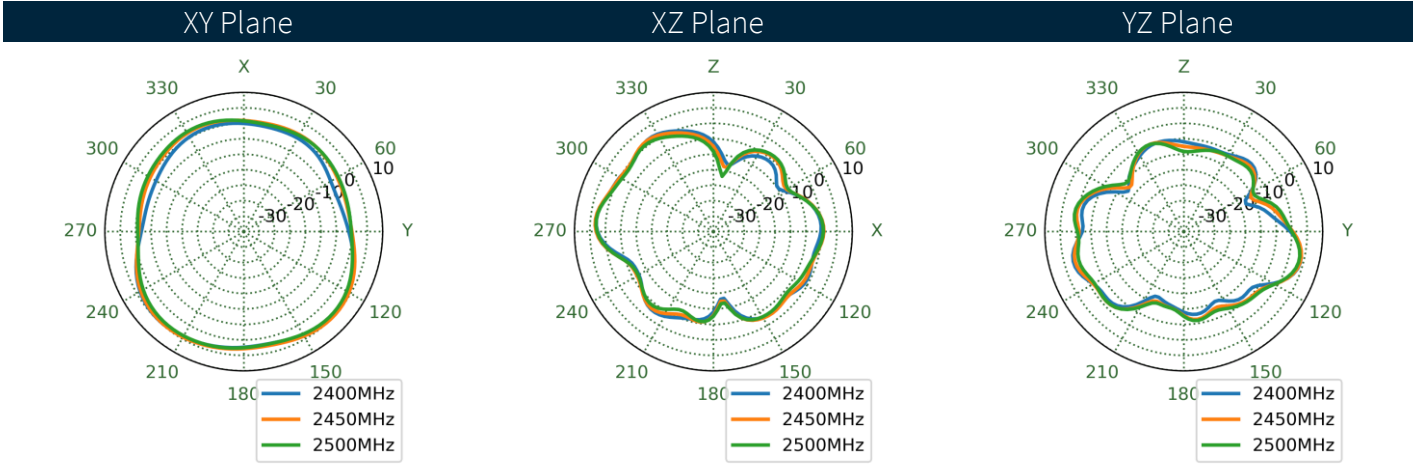
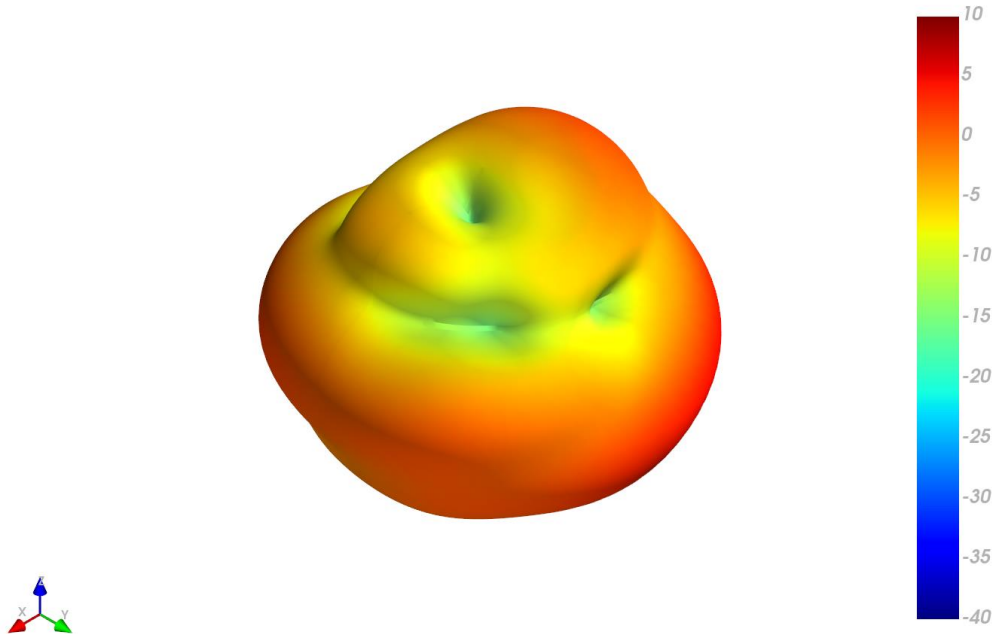

4.9 15x9cm Ground 3D and 2D Radiation Patterns at 5550 MHz

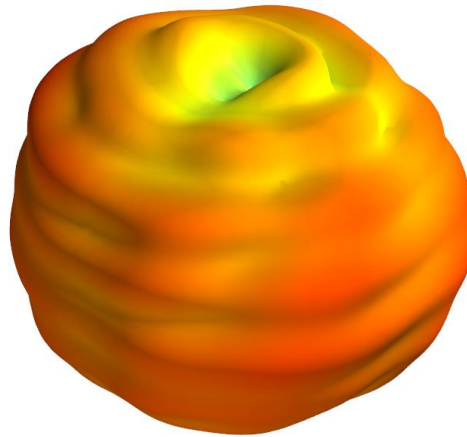

XY Plane XZ Plane YZ Plane

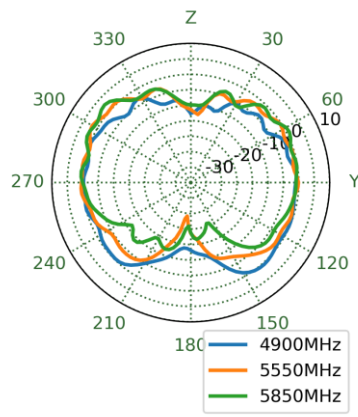
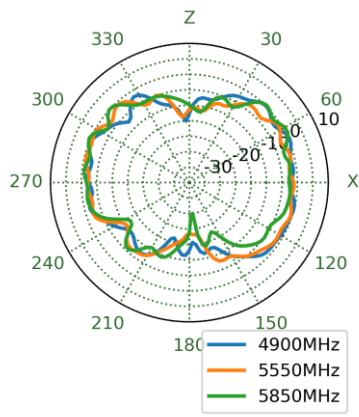
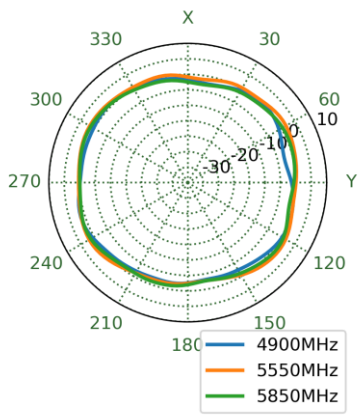

4.10 15x9cm Ground 3D and 2D Radiation Patterns at 6175 MHz

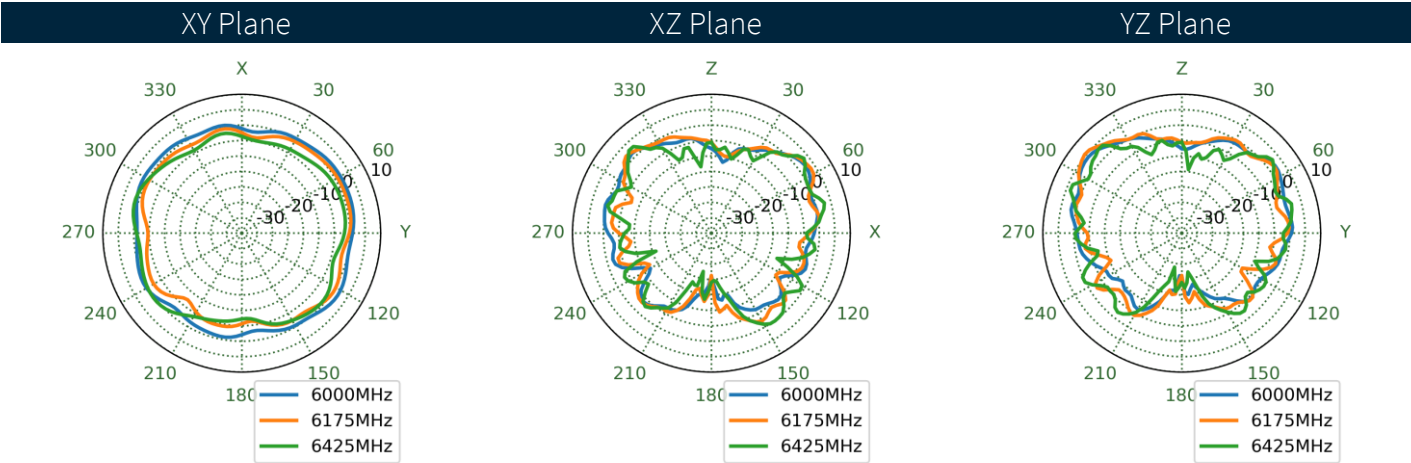
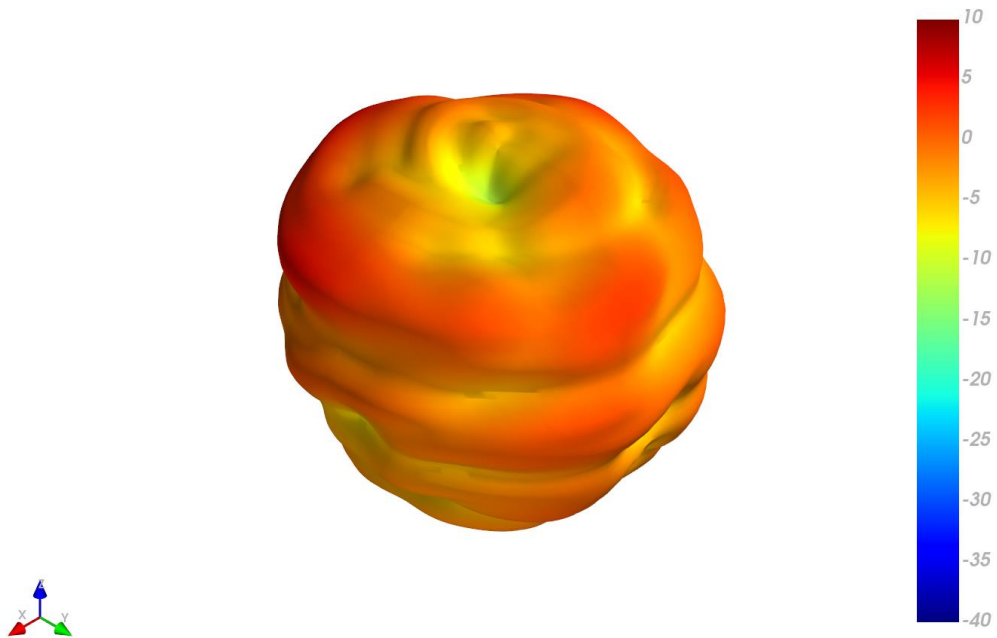

4.11 15x9cm Ground 3D and 2D Radiation Patterns at 6475 MHz

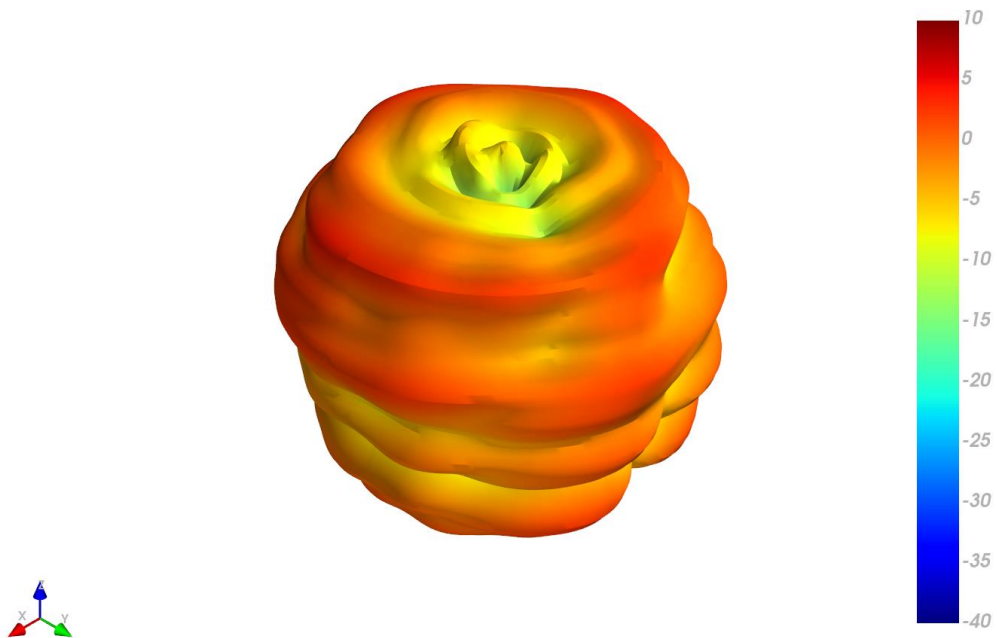

XY Plane XZ Plane YZ Plane

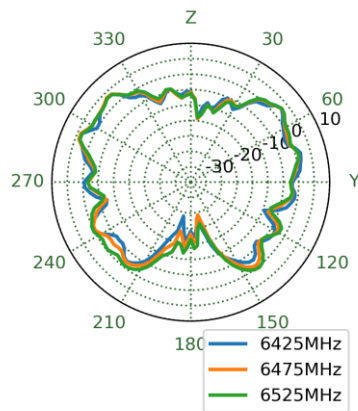
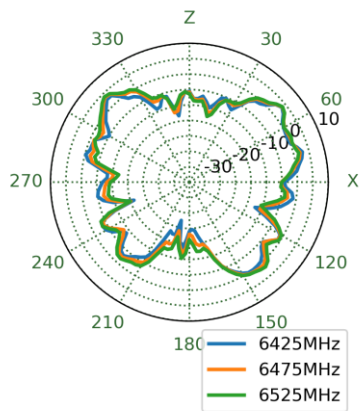
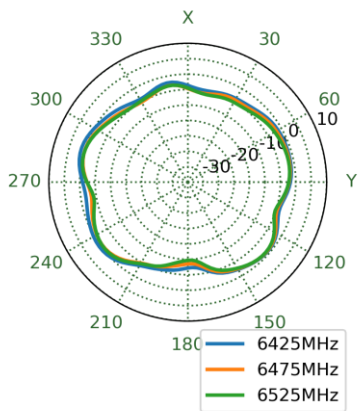

4.12 15x9cm Ground 3D and 2D Radiation Patterns at 6700 MHz

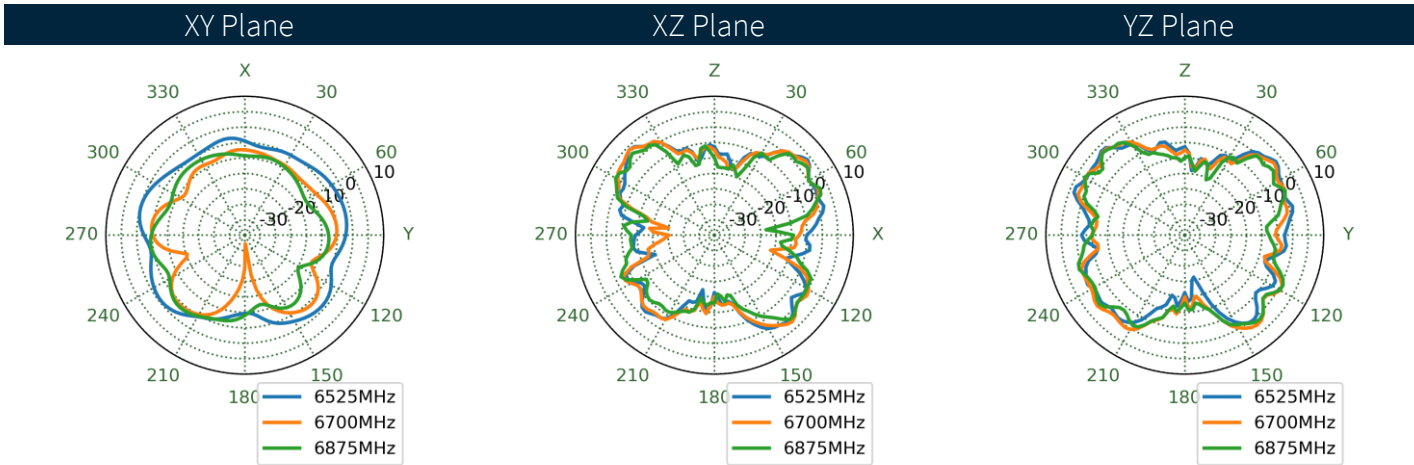
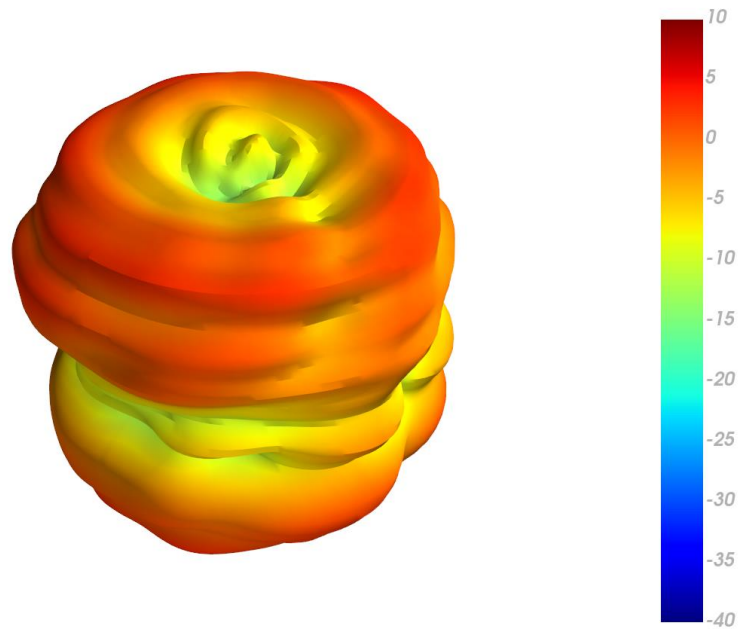

4.13 15x9cm Ground 3D and 2D Radiation Patterns at 7000 MHz

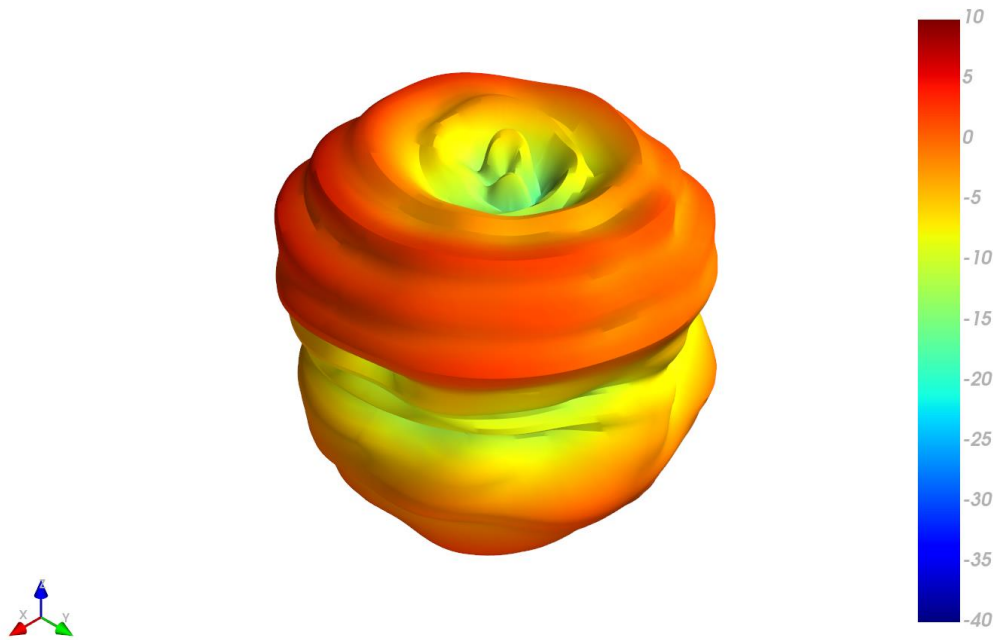

XY Plane XZ Plane YZ Plane

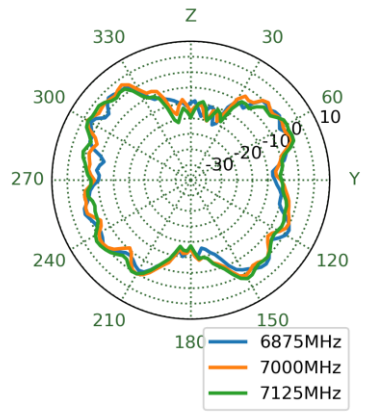
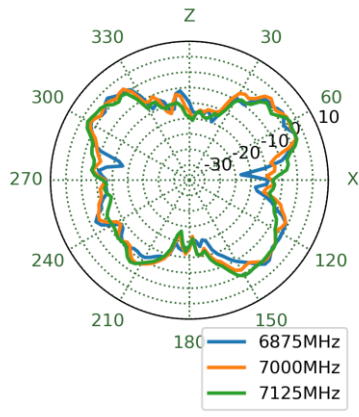
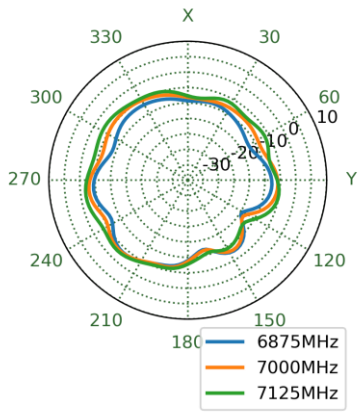

4.14 9x15cm Ground 3D and 2D Radiation Patterns at 2450 MHz

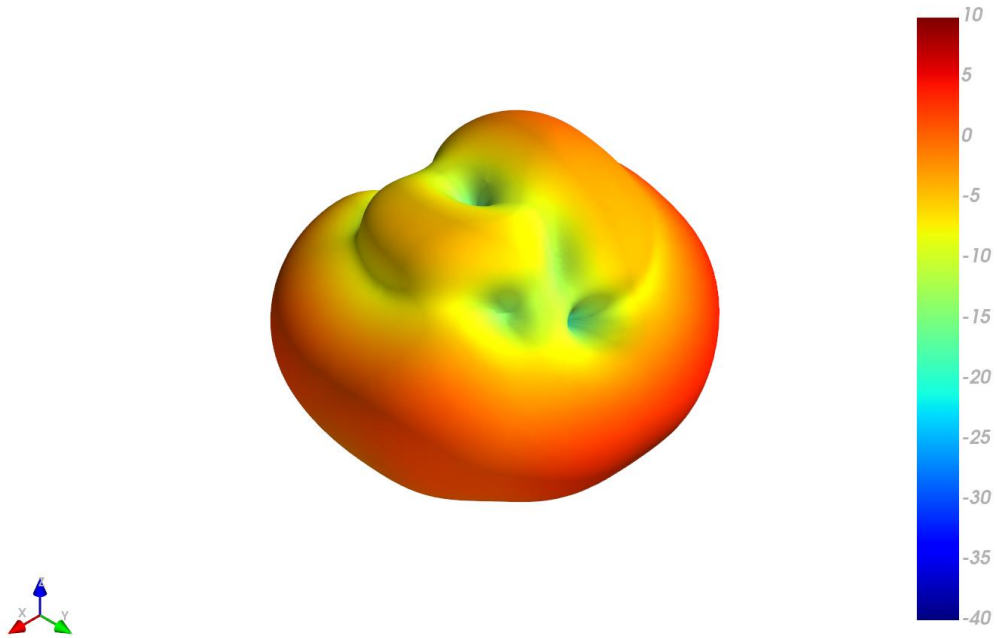

XY Plane XZ Plane YZ Plane

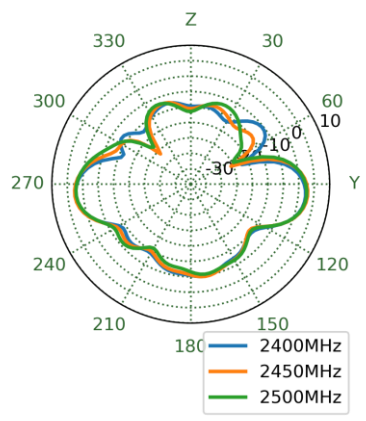
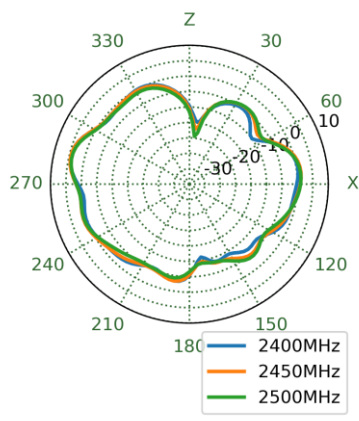
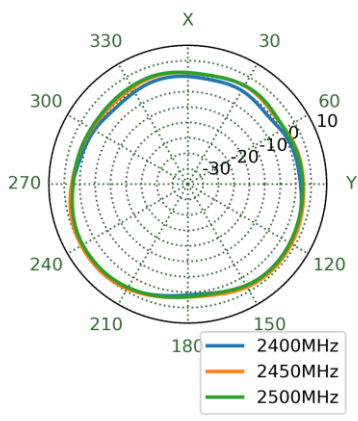

4.15 9x15cm Ground 3D and 2D Radiation Patterns at 5500 MHz

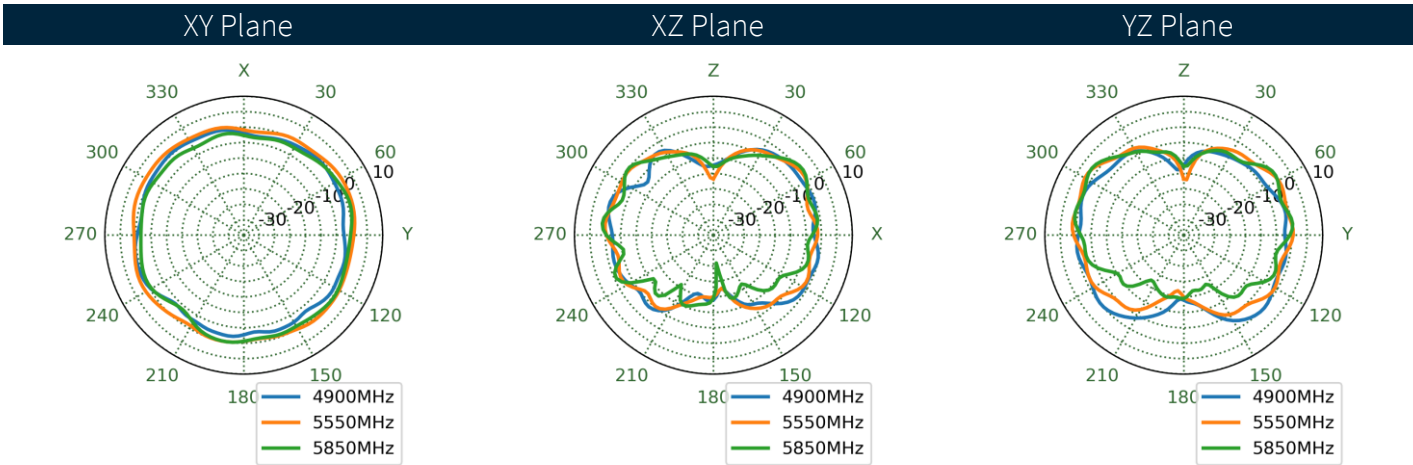
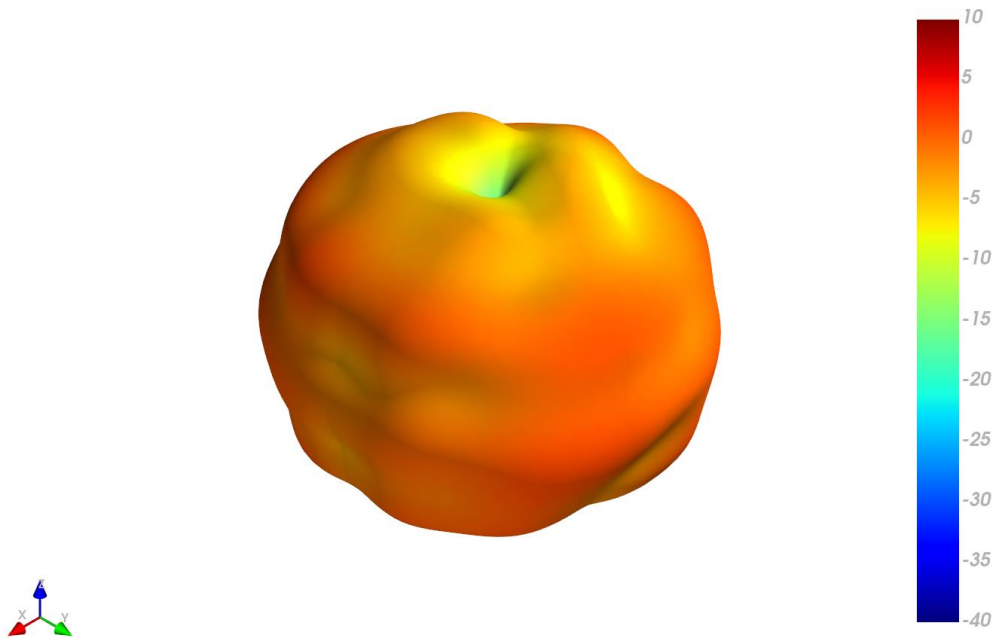

4.16 9x15cm Ground 3D and 2D Radiation Patterns at 6175 MHz

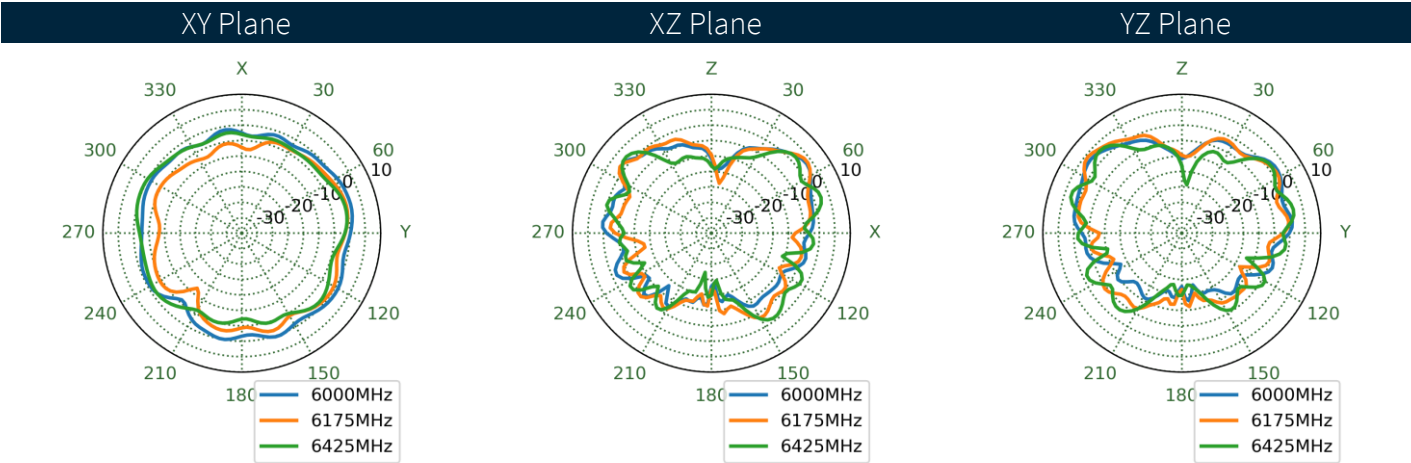
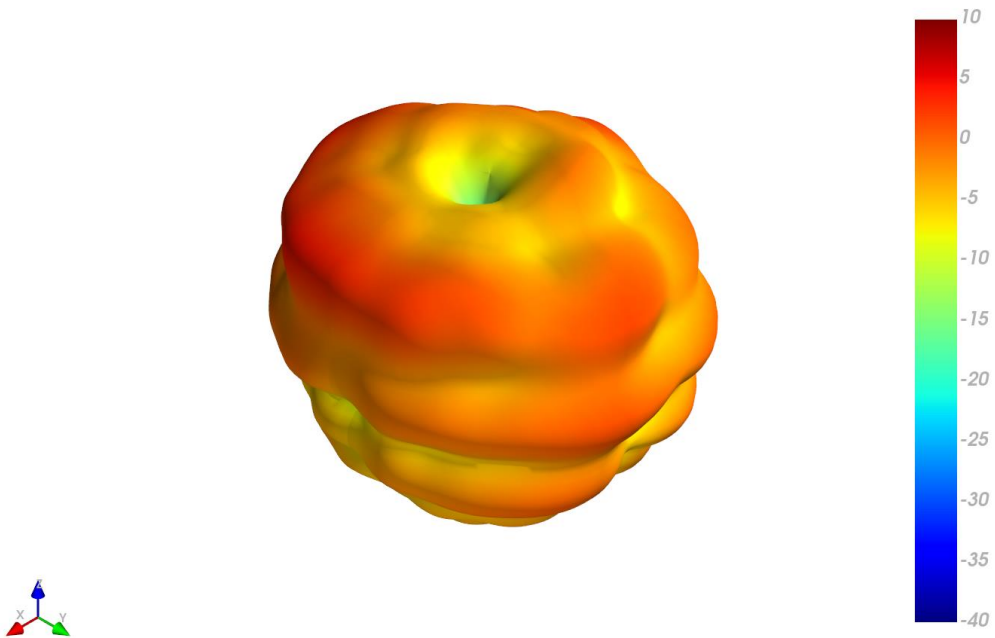

4.17 9x15cm Ground 3D and 2D Radiation Patterns at 6475 MHz

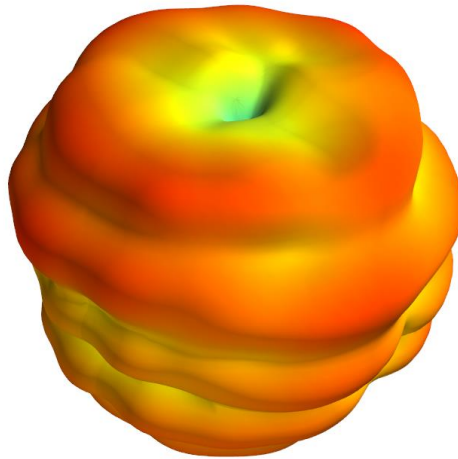

XY Plane XZ Plane YZ Plane

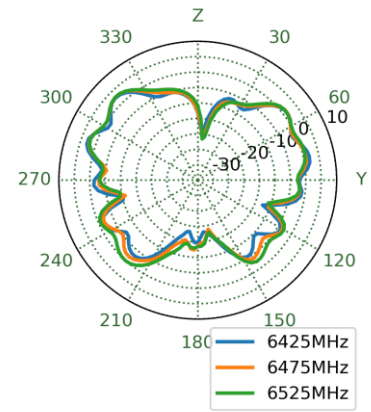
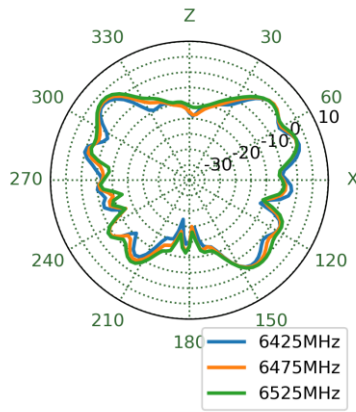
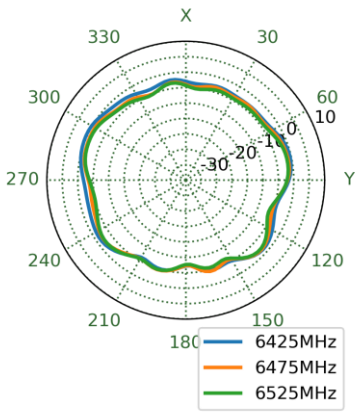

4.18 9x15cm Ground 3D and 2D Radiation Patterns at 6700 MHz

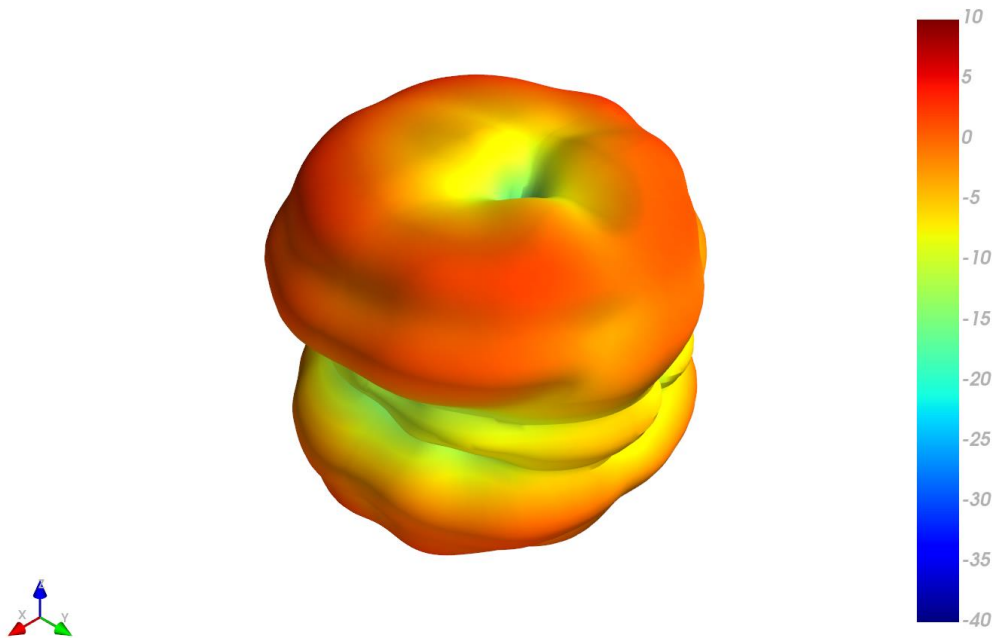

XY Plane XZ Plane YZ Plane

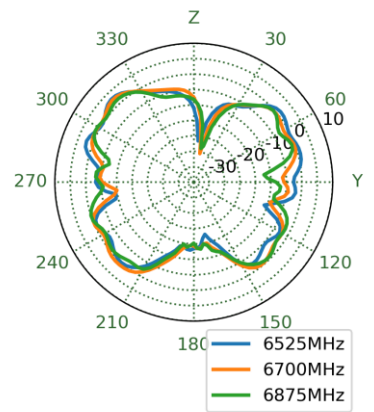
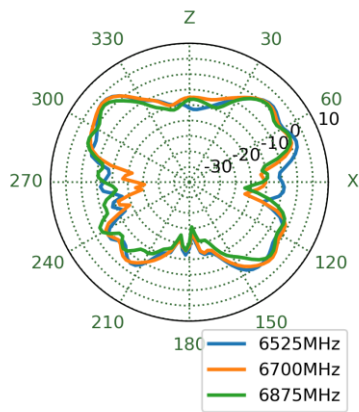
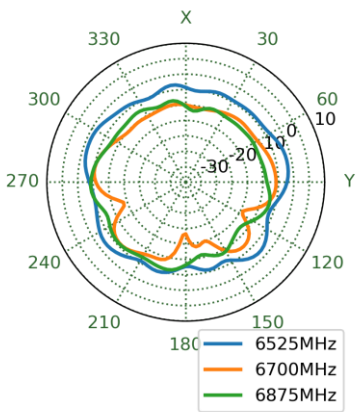

4.19 9x15cm Ground 3D and 2D Radiation Patterns at 7000 MHz

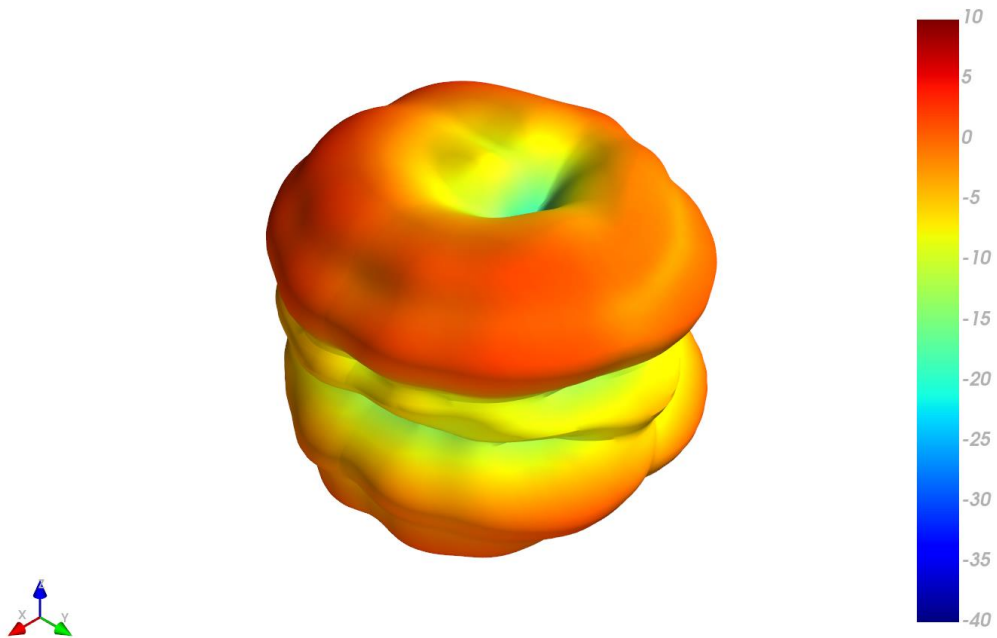

XY Plane XZ Plane YZ Plane

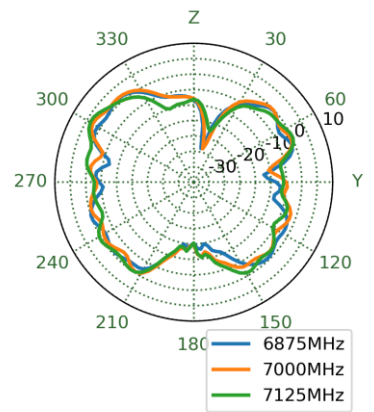
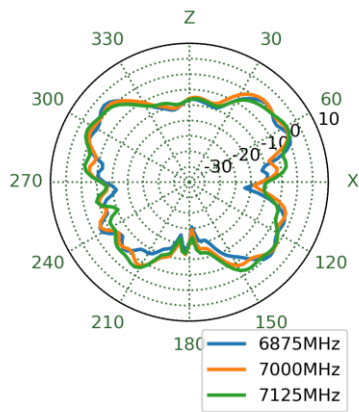
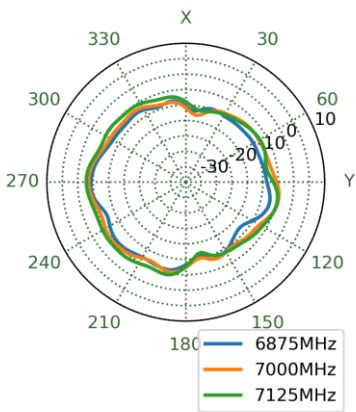

5. Mechanical Drawing

ISO NO.: EDW-23-8-0897

STATE: RELEASE

NOTES: 1. All material must be RoHS compliant.

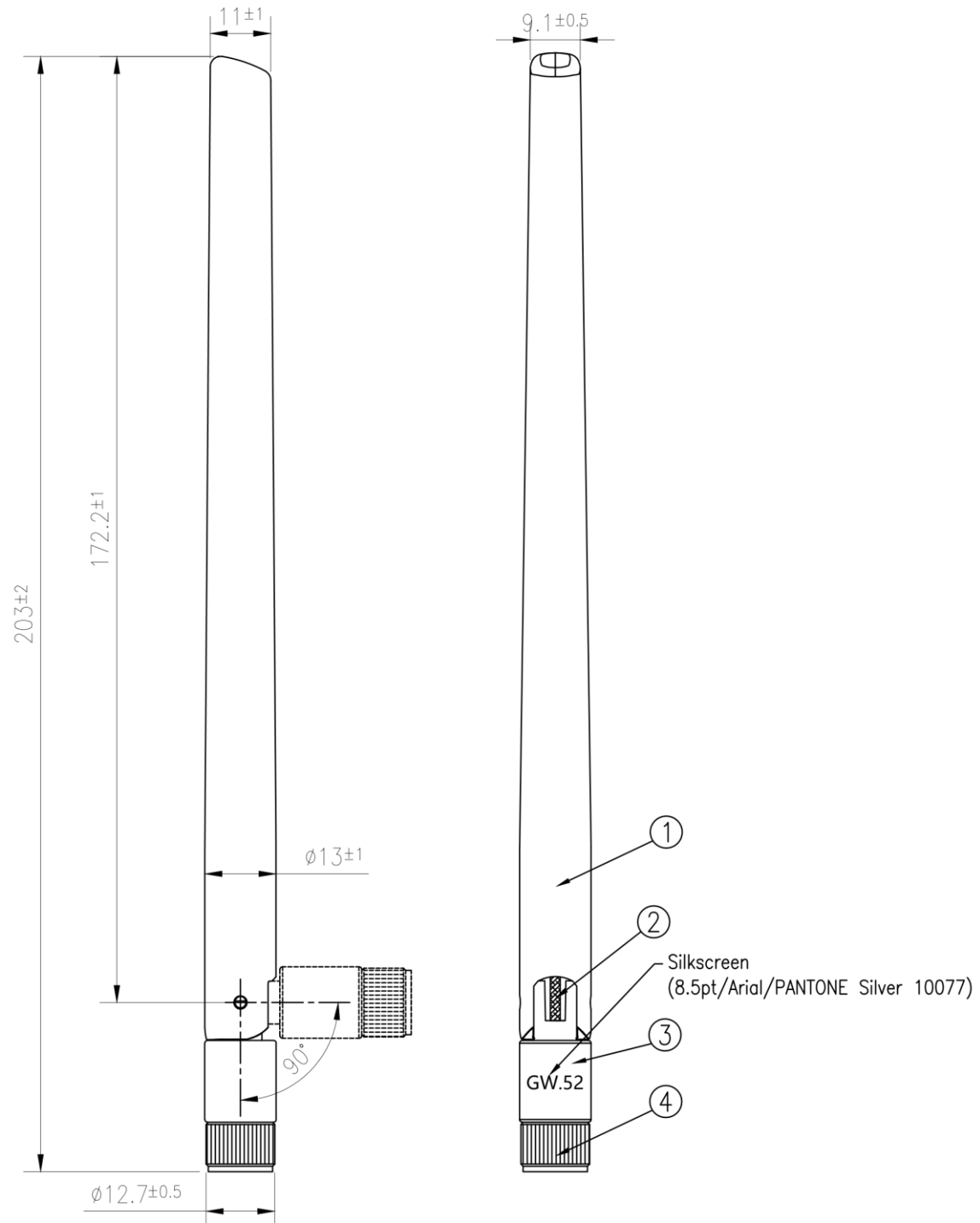

	Name	Material	Finish	QTY
1	Radome	PC+PBT	Black	1
2	RG178 coaxial cable	FEP	Brown	1
3	Lower Holder	PC+PBT	Black	1
4	RP-SMA(M)	PC+PBT	Black	1

6. Packaging

TBD

Changelog for the datasheet

SPE-23-8-272 – GW.52.A153

Revision: A (Original First Release)

Date:	2023-09-26
Notes:	Initial Release
Author:	Cesar Sousa

Previous Revisions



www.taoglas.com

