

**SERIES:** VOF-4 | **DESCRIPTION:** INTERNAL AC-DC POWER SUPPLY

**FEATURES**

- universal Input Range from 85~305 Vac
- high Efficiency up to 82%
- no load power <0.075W
- operating altitude up to 5,000m
- certified to EN/UL 62368-1
- over voltage category OVC II and OVC III
- continuous short circuit and over voltage protection

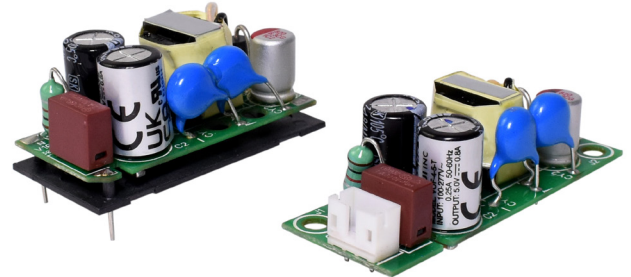

MODEL	output voltage	output current	output power	ripple and noise <sup>1</sup>	efficiency <sup>2</sup>
	(Vdc)	max (A)	max (W)	max (mVp-p)	typ (%)
VOF-4-3	3.3	1.2	4	100	74
VOF-4-5	5	0.8	4	100	77
VOF-4-12	12	0.333	4	120	81
VOF-4-15	15	0.266	4	150	81
VOF-4-24	24	0.166	4	240	82

Note: 1. Ripple and noise are measured at 20 MHz BW with 10 uF aluminum electrolytic capacitor and 0.1 uF ceramic capacitor on the output (For 3.3 Vdc output model 47 uF aluminum electrolytic capacitor and 0.1 uF ceramic capacitor.).  
 2. At 230 Vac input and full load, 25°C.  
 3. Chassis mount version wafer with JST B3B-PH / B2B-PH and mate with JST PH series or equivalent.

**PART NUMBER KEY**

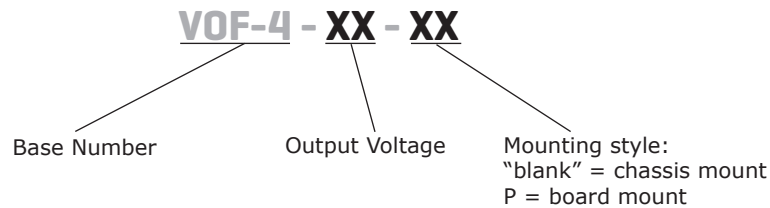

## INPUT

parameter	conditions/description	min	typ	max	units
input voltage		85		305	Vac
		120		431	Vdc
operating voltage		100		277	Vac
frequency		50		60	Hz
current	at 100 Vac, full load			0.25	A
inrush current	at 240 Vac, cold start, 25°C			70	A
leakage current				0.1	mA
no load power consumption				0.075	W

## OUTPUT

parameter	conditions/description	min	typ	max	units
capacitive load	3.3 Vdc output model			1,200	μF
	5 Vdc output model			800	μF
	12 Vdc output model			330	μF
	15 Vdc output model			266	μF
	24 Vdc output model			166	μF
initial set point accuracy	at full load				
	3.3 Vdc output model		±5		%
	5 Vdc output model		±4		%
	all other output models		±3		%
output voltage set point	at nominal input				
	3.3 Vdc output model	3.135	3.3	3.465	Vdc
	5 Vdc output model	4.80	5.0	5.20	Vdc
	12 Vdc output model	11.64	12	12.36	Vdc
	15 Vdc output model	14.55	15	15.45	Vdc
	24 Vdc output model	23.28	24	24.72	Vdc
line regulation	from high to low line, full load			±1	%
load regulation	0%~100% load				
	3.3 Vdc output model			±5	%
	5 Vdc output model			±4	%
	all other output models			±3	%
switching frequency	max rated power		43		kHz
hold-up time	at 115 Vac		16		ms

## PROTECTIONS

parameter	conditions/description	min	typ	max	units
over voltage protection	built-in a TVS component to clamp output voltage				
	3.3 Vdc output model	6.45		7.14	Vdc
	5 Vdc output model	6.45		7.14	Vdc
	12 Vdc output model	14.3		15.8	Vdc
	15 Vdc output model	17.1		19.5	Vdc
	24 Vdc output model	28.5		31.5	Vdc
over current protection	auto recovery, hiccup	110		180	%
short circuit protection	auto recovery				

## SAFETY & COMPLIANCE

parameter	conditions/description	min	typ	max	units
isolation voltage	input to output for 1 minute			3,000	Vac
safety approvals	certified to 62368-1: EN/UL				

## SAFETY & COMPLIANCE

safety class	Class II		
conducted emission	EN 61204-3:2018, EN 61000-6-3:2021, EN 61000-6-4:2019, Class B		
radiated emissions	EN 61204-3:2018, EN 61000-6-3:2021, EN 61000-6-4:2019, Class B		
ESD	IEC 61000-4-2:2008, perf. Criteria A		
radiated immunity	IEC 61000-4-3:2020, perf. Criteria A		
EFT/burst	IEC 61000-4-4:2012, ±1kV, ±2kV, perf. Criteria A		
surge	IEC 61000-4-5:2014+A1:2017, L-N: ±0.5kV, ±1kV, perf. Criteria A		
conducted immunity	IEC 61000-4-6:2013+COR1:2015, perf. Criteria A		
voltage dips	IEC 61000-4-11:2020, Dip: 30% Reduction, Dip >95% Reduction, perf. Criteria A		
voltage interruption	IEC 61000-4-11:2020, >95% Reduction, perf. Criteria B		
MTBF	per MIL-HDBK-217F at 25 °C	2,200,000	hours
RoHS	yes		

## ENVIRONMENTAL

parameter	conditions/description	min	typ	max	units
operating temperature	(see derating curve)	-40		80	°C
storage temperature		-40		85	°C
storage humidity		0		95	%

## DERATING CURVES

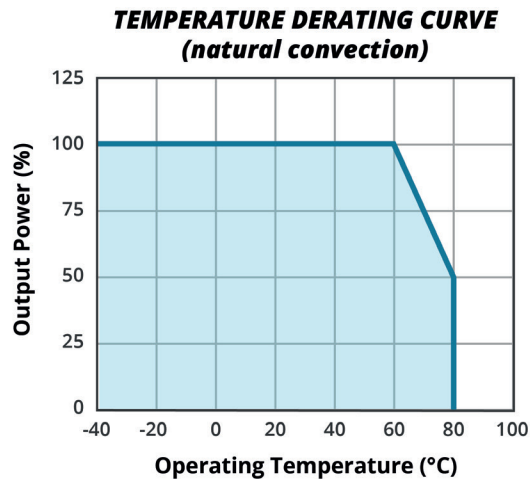

## EFFICIENCY CURVES

**EFFICIENCY VS OUTPUT LOAD  
(VOF-4-3)**

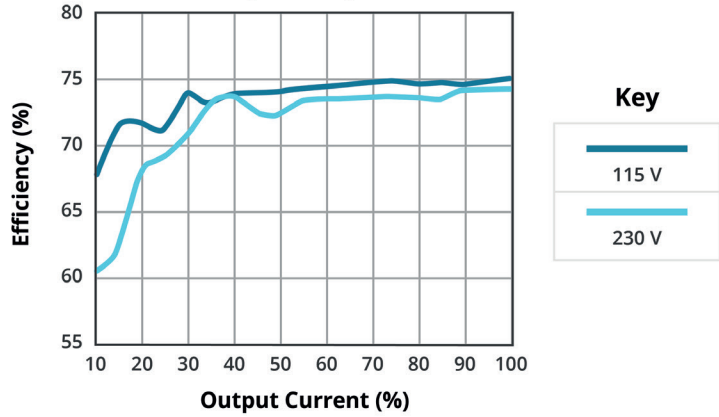

**EFFICIENCY VS OUTPUT LOAD  
(VOF-4-5)**

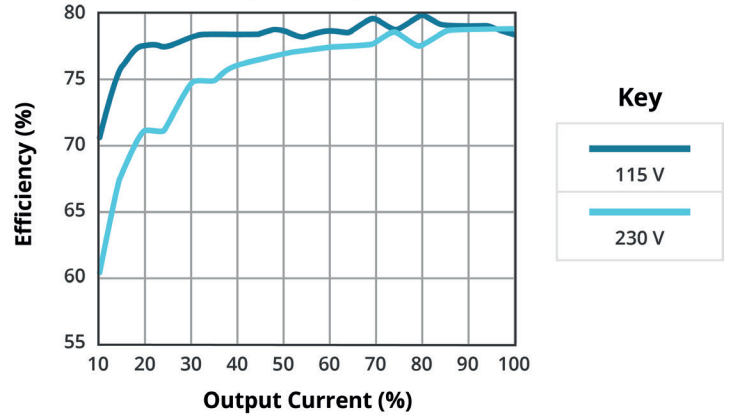

**EFFICIENCY VS OUTPUT LOAD  
(VOF-4-12)**

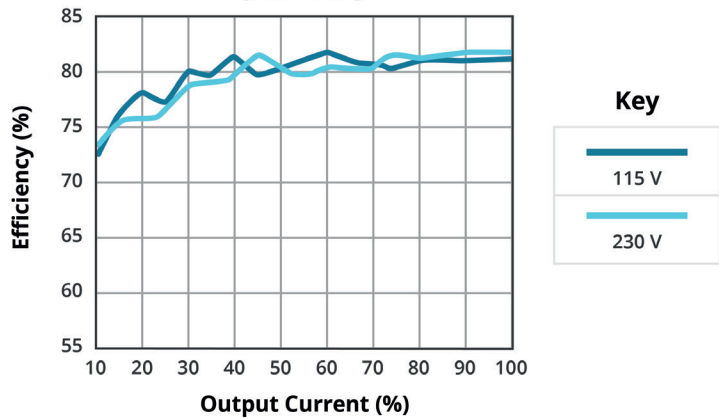

**EFFICIENCY VS OUTPUT LOAD  
(VOF-4-15)**

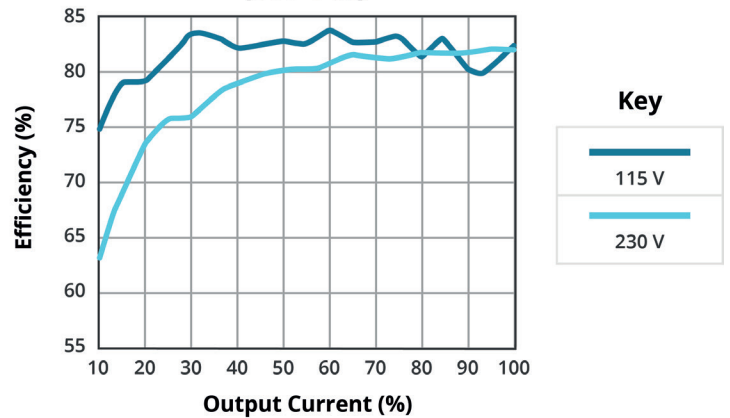

**EFFICIENCY VS OUTPUT LOAD  
(VOF-4-24)**

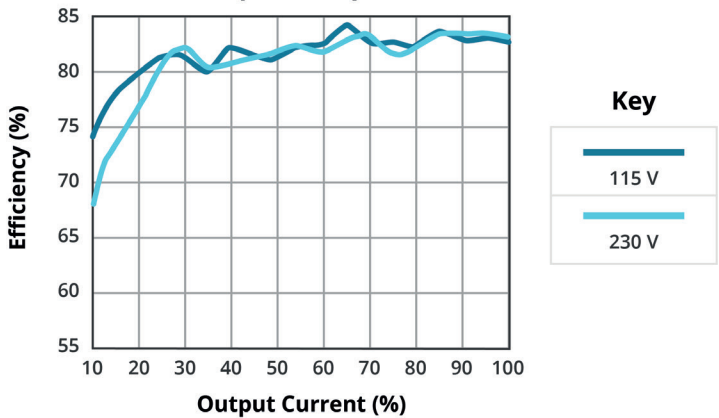

## MECHANICAL

parameter	conditions/description	min	typ	max	units
dimensions	chassis mount	1.95 x 0.71 x 0.689 [49.5 x 18.0 x 17.5 mm]			inch
	board mount	1.56 x 0.76 x 0.72 [39.5 x 19.4 x 18.30 mm]			inch
weight	chassis mount		12		g
	board mount		10		g

## MECHANICAL DRAWING (CHASSIS MOUNT)

units: inches: x.xx = ±0.03, x.xxx = ±0.020  
 mm: x.x = ±0.7, x.xx = ±0.50

PIN CONNECTIONS		
PIN	Function	Connector
1	AC (N)	CN1
2	AC (L)	
3	+Vout	CN2
4	-Vout	

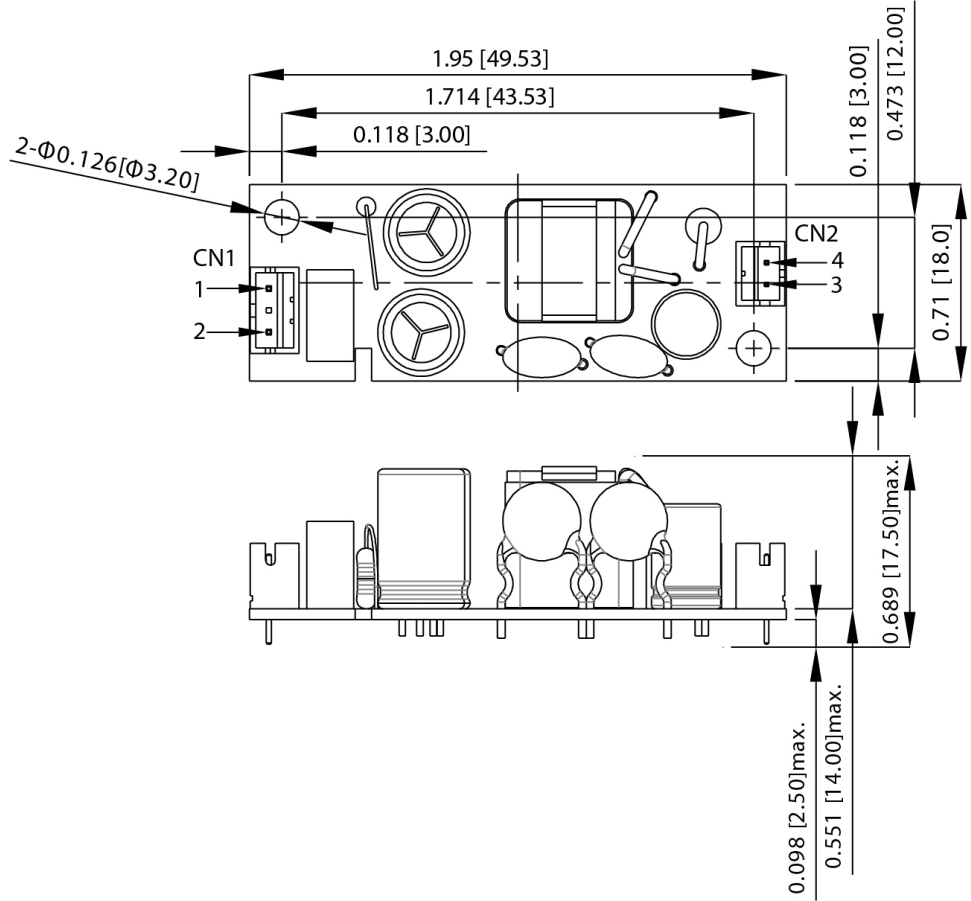

## MECHANICAL DRAWING (BOARD MOUNT)

units: inches: x.xx = ±0.03, x.xxx = ±0.020  
 mm: x.x = ±0.7, x.xx = ±0.50

PIN CONNECTIONS	
PIN	Function
1	AC (N)
2	AC (L)
3	+Vout
4	-Vout

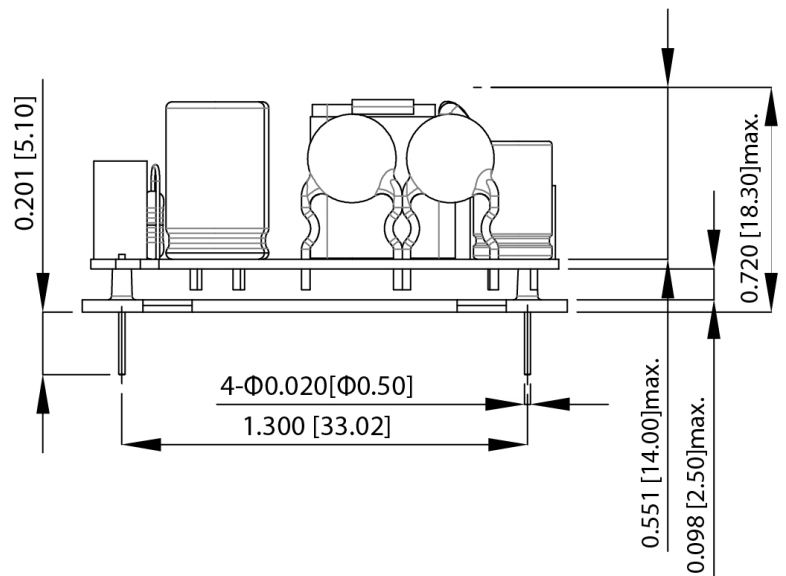
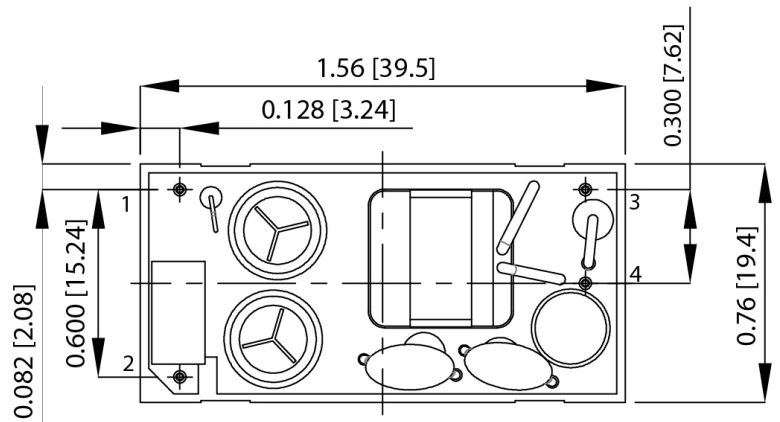

## REVISION HISTORY

---

rev.	description	date
1.0	initial release	10/09/2023

The revision history provided is for informational purposes only and is believed to be accurate.



**Headquarters**  
20050 SW 112th Ave.  
Tualatin, OR 97062  
**800.275.4899**

Fax 503.612.2383  
**cui.com**  
techsupport@cui.com

CUI offers a two (2) year limited warranty. Complete warranty information is listed on our website.

CUI reserves the right to make changes to the product at any time without notice. Information provided by CUI is believed to be accurate and reliable. However, no responsibility is assumed by CUI for its use, nor for any infringements of patents or other rights of third parties which may result from its use.

CUI products are not authorized or warranted for use as critical components in equipment that requires an extremely high level of reliability. A critical component is any component of a life support device or system whose failure to perform can be reasonably expected to cause the failure of the life support device or system, or to affect its safety or effectiveness.