



Sub- μ A Current Sensor

RD-UAMP-SENSOR

Last Updated: Oct 26, 2023

The Sub- μ A Current Sensor is a Kinetis K22F-based current measurement board running on FreeRTOS, for use with the Freedom Development Ecosystem or any other Arduino-like development boards.

This Reference Design allows for nonintrusive interfacing between any MCU and 3.3V shield, and measurement of a large range of low currents (~60 nA – 5 mA). Multiple communication methods are available, including integration with Freedom Sensor Toolbox (CE).

RD-UAMP-SENSOR Block Diagram Block Diagram

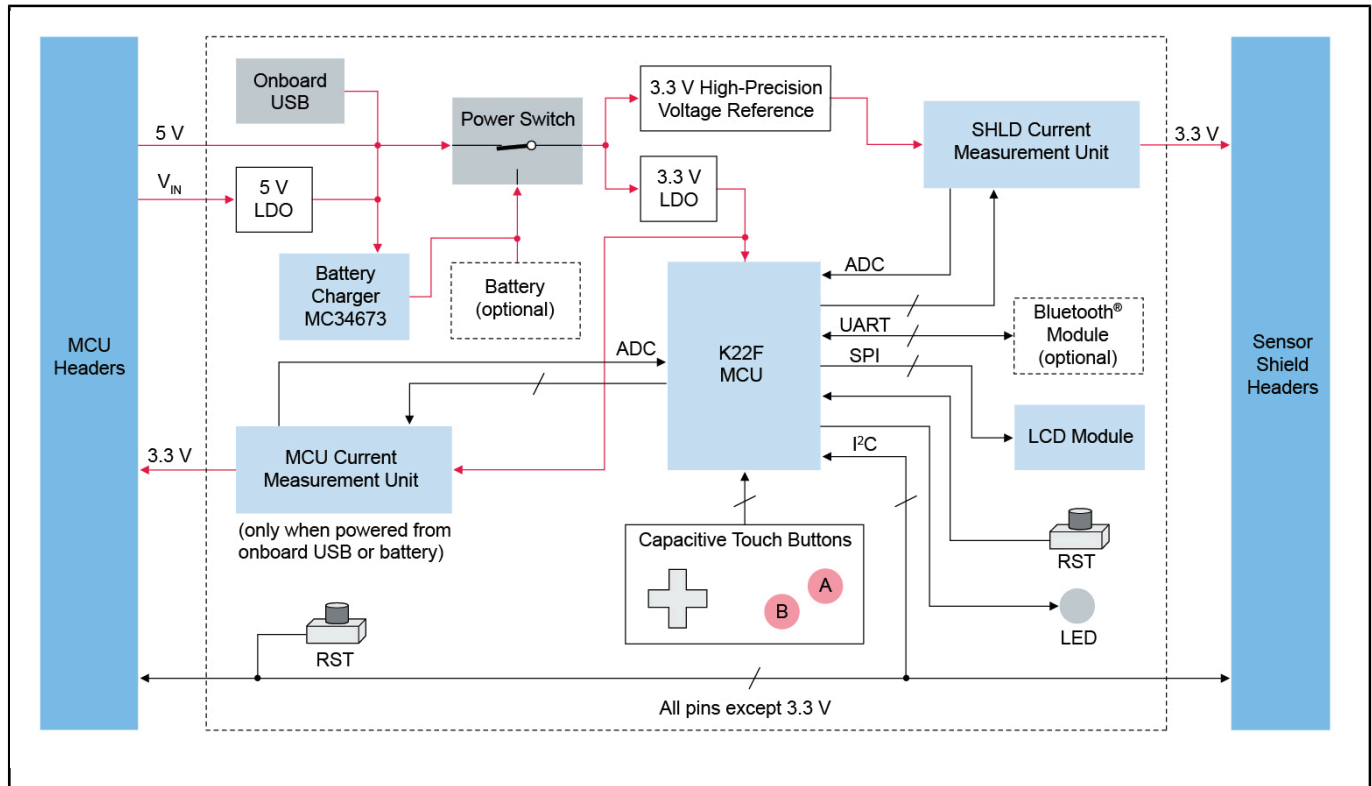

View additional information for [Sub- \$\mu\$ A Current Sensor](#).

Note: The information on this document is subject to change without notice.

www.nxp.com

NXP and the NXP logo are trademarks of NXP B.V. All other product or service names are the property of their respective owners. The related technology may be protected by any or all of patents, copyrights, designs and trade secrets. All rights reserved. © 2023 NXP B.V.