



Technical Bulb Guide

Discover New Possibilities



More than just a bulb in a box

Innovation, OE quality and award winning products

Specialist bulbs

Quality Assured

24V bulbs

Largest range of bulbs
Innovators in Performance Halogens
LED Bulbs
HID Bulbs

Marketing Support
UK Technical Support and Customer Services

Merchandising and Planogramming

Industry-leading Cataloguing
Ranging
Up-to-date application guide
Staff training

Next day delivery





Welcome to Ring

Ring is a leading European supplier to the automotive aftermarket, providing exceptional quality bulbs, tyre care products, battery care products, dash cameras, garage and workshop equipment and vehicle conversion components. Ring has over 40 years' experience in the automotive sector, pushing the boundaries in automotive lighting, auto electrics and professional equipment.

Quality and service are at the centre of everything Ring does. We work with businesses to help them reach their goals, and ensure that our products perform exceptionally for the motorists, technicians, fleet managers and professionals using them on a daily basis. Our success has been shown in the 200+ product awards we've won throughout Europe, for products including our high performance halogen bulbs, tyre care, professional battery analysis tools and inspection lighting.

Headquartered in Leeds, UK and with our European office in Paris, we are ideally placed to help meet the needs of our customers. Ring's specialist team of over 165 people across Europe, ensures we are at the forefront of product development, quality assurance and customer support services. From our purpose-built 6000m² distribution facility, Ring fulfils 64,000 orders to over 60 countries annually. UK customers benefit from a next day delivery service and with 6500 pallet locations in the warehouse holding 6000 different product lines, Ring is proud of its 97% availability rate, meaning customers get the products they need in a timescale that works for their business.

www.ringautomotive.com



Vehicle Lighting



Commitment to Quality

With nearly forty years' experience in the manufacture and distribution of automotive lighting, Ring's commitment to quality is second to none.

Through major investments in test equipment and fully qualified staff, Ring has created a Quality Assurance Department that is at the forefront of Automotive Lighting. Ring recognises quality is of the utmost importance in helping to ensure customer satisfaction and with this in mind Ring's Quality Assurance Department carries out stringent quality control procedures on a continuous basis.

It has achieved the highest standards in Quality Assurance and has been independently assessed by BSI. The department has been awarded ISO:9001 for the manufacture and assembly of automotive lighting. This is regularly and independently verified by BSI and the standard has now been achieved over a period of many years. This independent Quality Assessment is vital when it comes to Ring's original equipment programme where the best in the world OEM's continue to place business with Ring Automotive. The Quality Assurance Department monitors and assesses all the bulbs in the Ring Auto Bulb range. Using the sampling techniques laid down by BS6001 bulbs are checked to the relevant ECE and BS standards.

The Quality Assurance Department carries out a much bigger role than simply testing our existing products.

The department's extensive facilities are used in the continuous process of product development, comparing the performance of existing products to those utilising the very latest technologies. It works closely with our manufacturing partners in developing those new technologies.

It is also able to monitor and assess the general quality of the market place issuing regular updates on other bulbs available. Working in close cooperation with our customers it can issue technical reports on request.





Light Tunnel Laboratory

Designed and developed by Ring, the lighting laboratory is a unique installation that allows product testing and performance verification beyond that laid down by international standards.

The state-of-the-art laboratory is equipped with the latest ProMetric CCD light imaging photometer. Where a traditional goniophotometer can only measure the light intensity and colour from the lamp at one point at a time, the new ProMetric photometer can measure 8 million points simultaneously. Localised light and colour difference can easily be detected by looking at the individual measurements taken from any point. These measurements can then be displayed as a conventional image or via a colour isolux image.

These images clearly illustrate the performance of both the light unit and the light source and can be used to access the relative

performance of products. Our extensive database now contains many thousands of results which can be used to improve both our understanding of our products performance but also other products sold in the market.

The data is used to further enhance and improve our products. The specially designed software allows data to be shown as overhead images to produce a bird's eye view of the product's enhanced performance on the road ahead. The performance of products can be checked against the international standards using the reference data points from European headlamp standards.

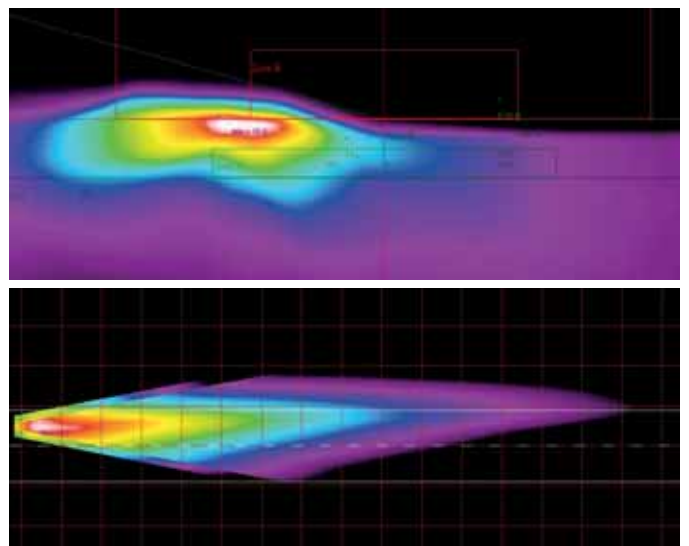

Vehicle Lighting

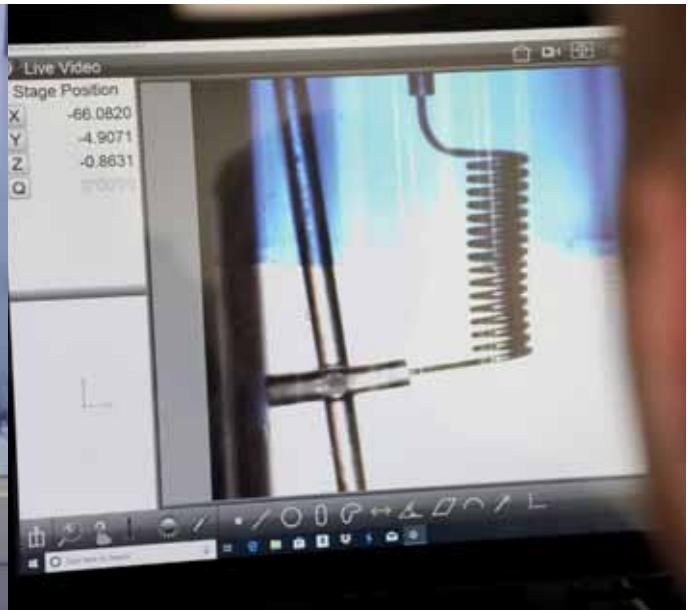

Quality Control

Luminosity and Colour

Using an Integrated Photometer, luminosity or the light output, is measured. This calibrated sphere compares, the light output of the sample against a calibrated bulb from the National Physics laboratory. The light output is then checked and verified against the relevant standard. Bulbs are checked for colour compliance by comparing the output to chromaticity values defined in the standards.

Life Testing

Bulbs are tested for their static life using a computer controlled life test rack.

This accelerates the life of a bulb using increased voltage between 110.0-116.6% as specified by BSI or I.E.C standards.

This life test is not a continuous test, but a cycle test that switches the bulbs off and on, to put the maximum load on the bulbs. In the case of twin filament headlamp bulbs the test alternates between the main and dipped beam filaments.

Lamp Dimensions and Filament Positions

Lamp dimensions and filament positions are verified on a shadowgraph magnification projector.

With the increasing use of complex surface reflectors on both front and rear lighting it is becoming more important that the filament is located at the correct position. Failure to do this will result in a very poor beam pattern as the source of light is not at the focal point of the lamp.

Vibration Testing

Whilst there is no international requirement for vibration testing within ECE specifications, Ring carries out vibration testing in its laboratories.

The amplitude and the frequency of the vibration can be adjusted to create a variety of adverse conditions. This test is the nearest we can get to simulating what happens on the road and is particularly relevant to the arduous conditions found in the commercial vehicle market. Ring is able to benchmark its products and those available in the market place.

Ring TruckMaster Heavy Duty Long Life range is tested in accordance with IEC60810-2003 (Lamps for road vehicles - Performance requirements). Bulbs are tested for performance in controlled condition of high vibration and shock over a period of 20 hours.

Other procedures carried out:

- Envelope to lamp holder test – the bulb is torque tested against calibrated weights to ensure the cap is secure.
- Cap dimensional test – the bulb cap is checked against calibrated gauges to ensure the correct fit to a lamp holder.
- Envelope test – the glass envelope is checked against calibrated gauges to ensure the correct size.



Product Development and Testing

Ring's Quality Assurance Department carries out a much bigger role than simply testing auto bulbs.

The department's extensive facilities are used in the continuous process of product development, comparing the performance of existing products to those utilising the very latest technologies. It works closely with our engineers in developing those new technologies.

The facilities to capture data and log actual performance together with extensive test equipment provides valuable

assistance in creating new products in the auto electrical and power management product categories.

As new vehicles embrace new technologies such as 'Stop Start' battery systems Ring already has in place a range of battery chargers to meet the market demand.



Vehicle Lighting

12V Passenger Vehicles

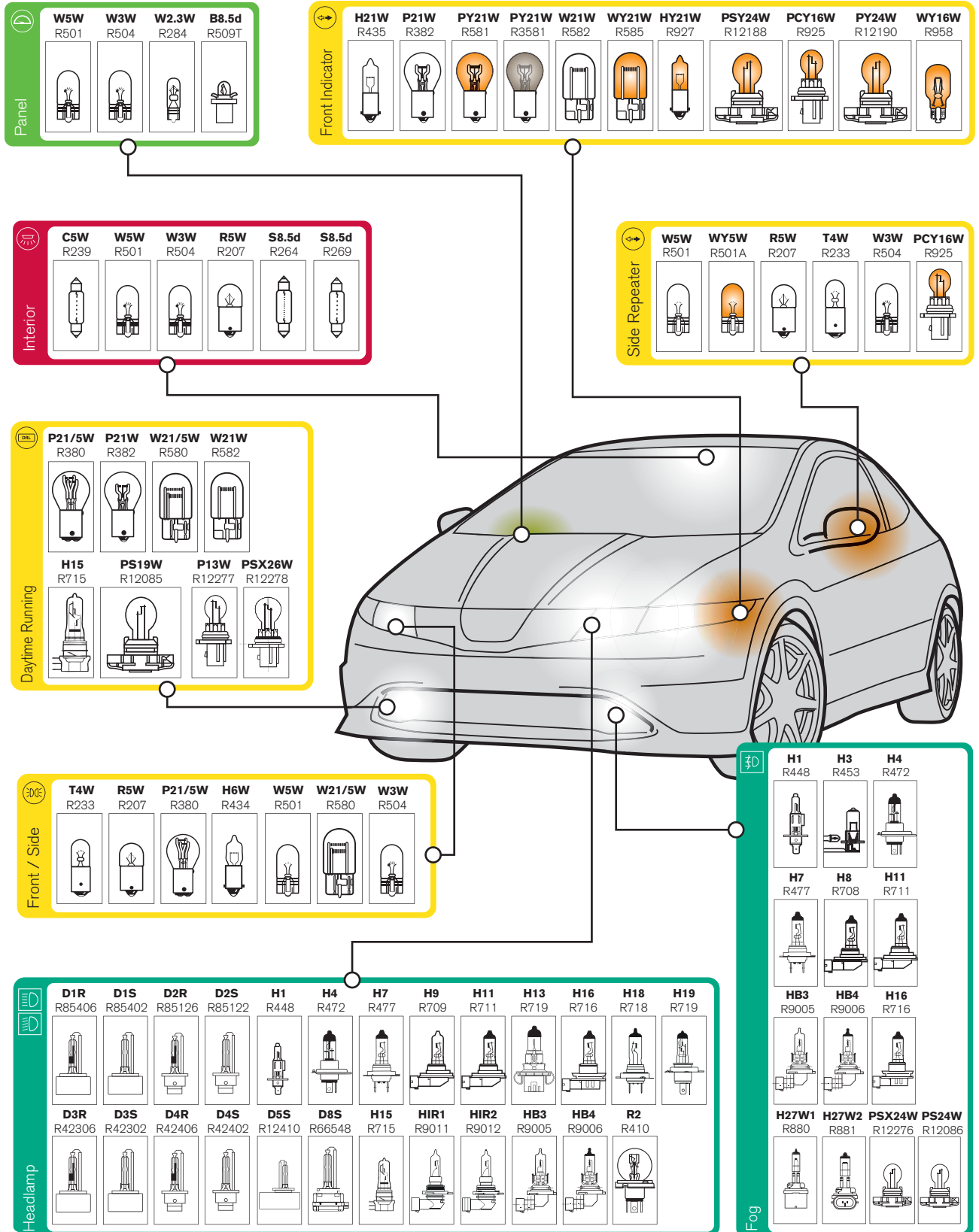

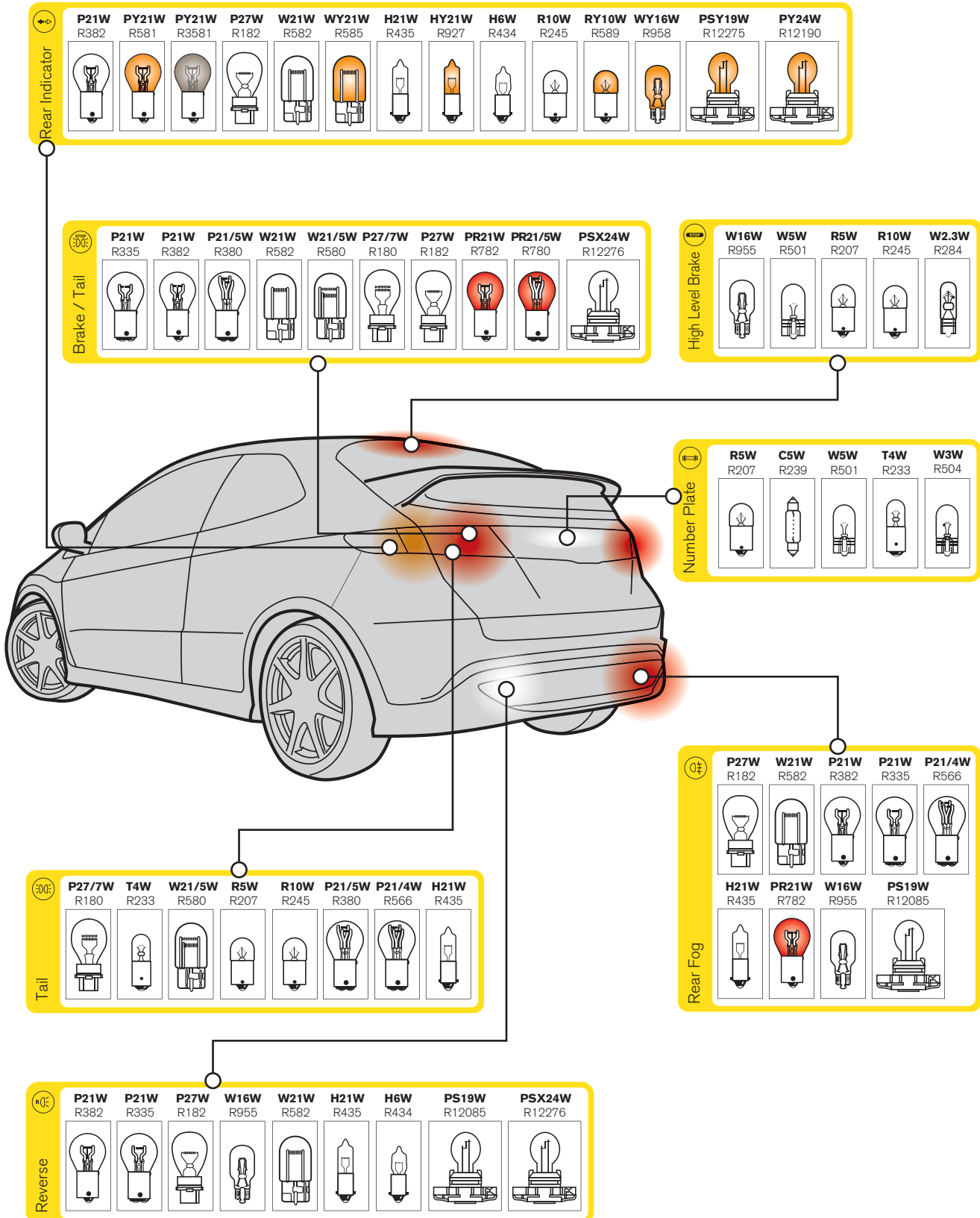

Vehicle Lighting

24V Commercial Vehicles

Headlamp

D1R R85406	D1S R85402	D2R R85126	D2S R85122	H1 R466	H4 R475	H7 R474
D3R R42306	D3S R42302	D4R R42406	D4S R42402	D8S R66548	R2 R429	H11 R458

Panel

W5W R507	W3W R505	T5 R508	B8.5d R508T	BA7 R283	BA9 R289	BA9 R865
--------------------	--------------------	-------------------	-----------------------	--------------------	--------------------	--------------------

Interior

C5W R242	W5W R507	R5W R149	S8.5d R274
--------------------	--------------------	--------------------	----------------------

Front / Side

T4W R249	R5W R149	R5W R150	W3W R505	W5W R507
--------------------	--------------------	--------------------	--------------------	--------------------

Fog

H1 R466	H3 R460	H7 R474	H11 R458
-------------------	-------------------	-------------------	--------------------

Front Indicator

H21W R535	P21W R241	PY21W R588	P21W R346
---------------------	---------------------	----------------------	---------------------

Outline Marker

T4W R249	C5W R242	R5W R149	R5W R150	W3W R505	W5W R507
--------------------	--------------------	--------------------	--------------------	--------------------	--------------------

Rear Indicator

H21W R535	P21W R241	PY21W R588	P21W R346
---------------------	---------------------	----------------------	---------------------

Rear Fog

P21W R241	P21W R346	P21/4W R567	H21W R535
---------------------	---------------------	-----------------------	---------------------

Brake / Tail

P21/5W R294	P21W R241	P21W R346
-----------------------	---------------------	---------------------

Reverse

P21W R241	P21W R346	H21W R535
---------------------	---------------------	---------------------

Tail

R5W R149	R5W R150	R10W R246	W3W R505	W5W R507
--------------------	--------------------	---------------------	--------------------	--------------------

Number Plate

T4W R249	C5W R242	R5W R149	R5W R150	W5W R507
--------------------	--------------------	--------------------	--------------------	--------------------

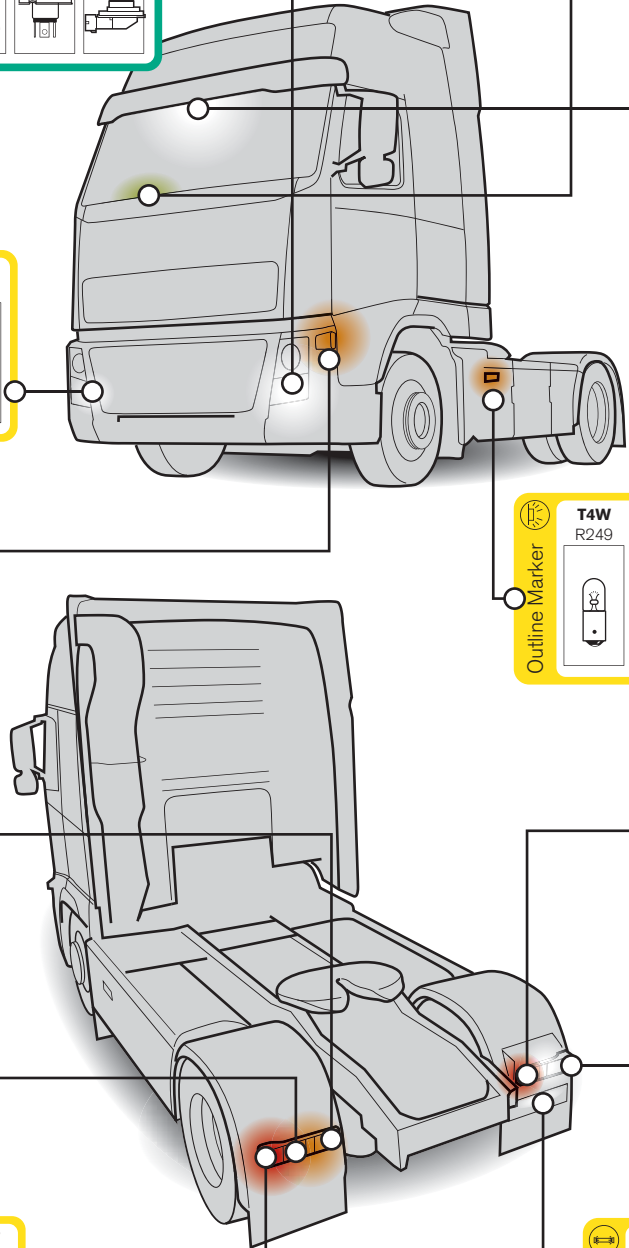

6V & 12V Motorcycles

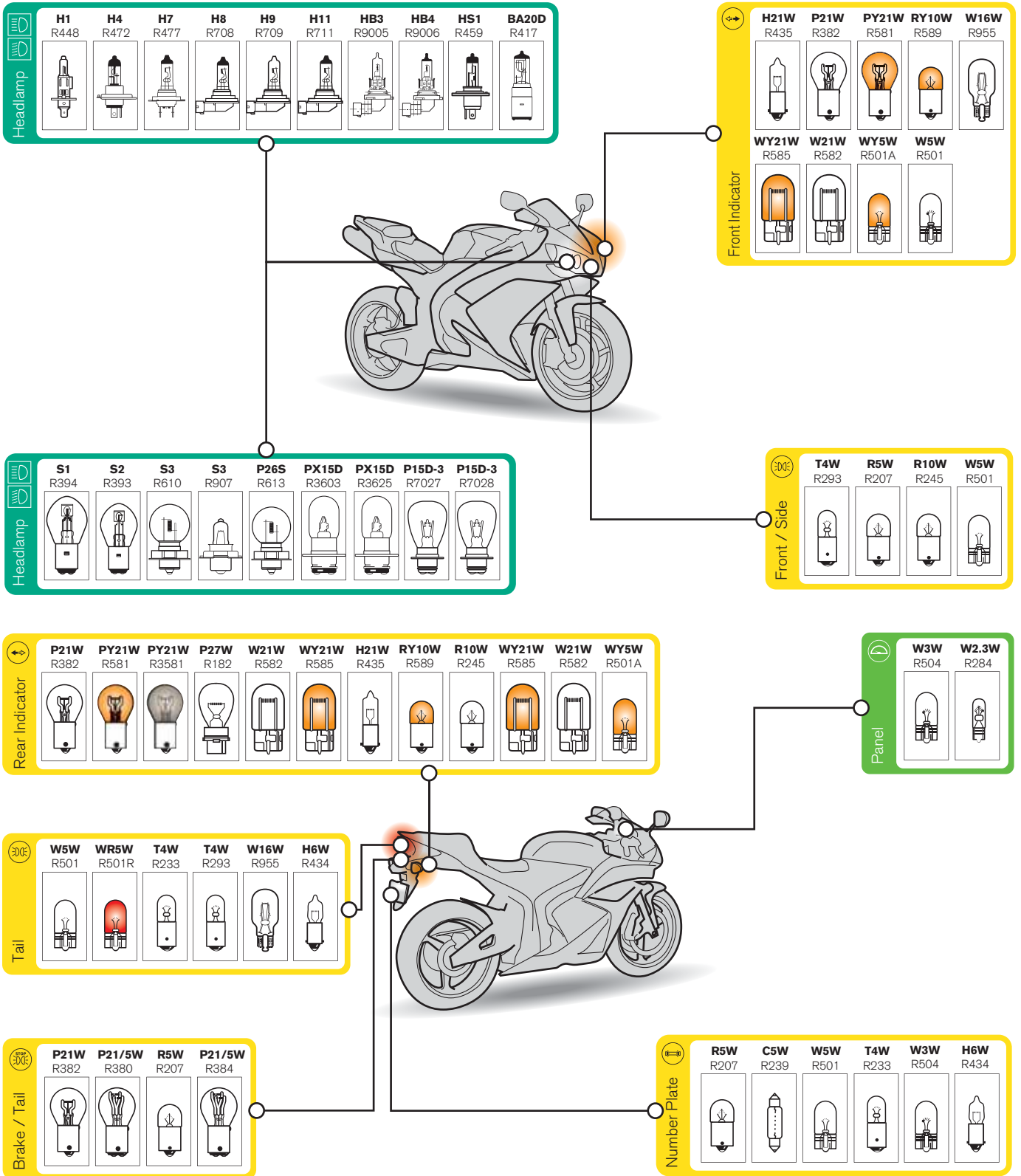

Vehicle Lighting

Which bulb should I choose?

BRIGHTER

I want more light on the road ahead

WHITER

I want a whiter looking headlamp

LONGER LIFE

I want a longer lasting headlamp



**Xenon150
Brighter Headlamp**

Up to 150%* more light on the road for a safer and more comfortable journey.

**+150%
more light**



**Xenon5000
Whiter Headlamp**

Up to 5000K Xenon cool white light.

**+50%
more light**



**Long Life
Headlamp**

Lasts up to 3x longer than a standard equivalent bulb. Ideal for high mileage drivers.



**Xenon130
Brighter Headlamp**

Up to 130%* more light on the road for a safer and more comfortable journey.

**+130%
more light**



**Xenon4400
Whiter Headlamp**

Up to 4400K Xenon cool white light.

**+30%
more light**



**XenonMax
Brighter Headlamp**

Up to 100%* more light on the road. Enhanced performance for greater light output.

**+100%
more light**



**Xenon4000
Whiter Headlamp**

Up to 4000K Xenon cool white light.



**UltraXenon
Brighter Headlamp**

Up to 60%* more light on the road. Enhanced performance for greater light output.

**+60%
more light**



**RallySport
Brighter Headlamp**

Off-road – intense white light and high power beam (80 – 160W).

OFF ROAD



**SportzBlue
Whiter Headlamp**

Intense blue-white light and high power beam (80 – 100W).

OFF ROAD

Off road only

*compared to standard halogen bulb



Xenon150 Brighter Headlamp

Puts up to 150%* more light on the road

- Up to 150% more light on the road ahead allows the driver to see more at a distance of 75m
- See and be seen with a beam pattern up to 80m longer than a standard bulb
- Better visibility of road markings and signs
- A whiter look in the headlamp compared to a standard bulb
- No changes to vehicle wiring required

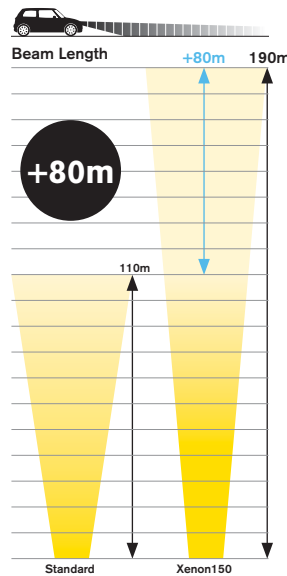

+150%

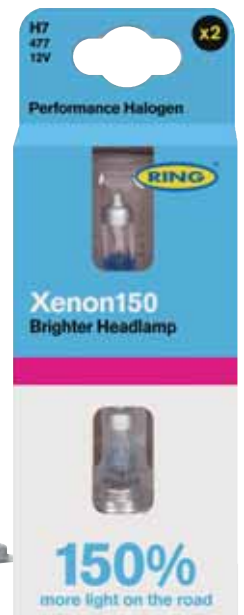

Colour Temperature (Kelvin)

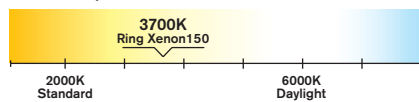

Twin

Part No	Voltage	Wattage	ECE	Cap	Kelvin	Upgrades	Barcode
RW1548	12V	55W	H1	P14.5s	3700K	R448	5055175244907
RW1572	12V	60/55W	H4	P43t	3700K	R472	5055175240800
RW1577	12V	55W	H7	PX26d	3700K	R477	5055175240479
RW1511	12V	55W	H11	PGJ19-2	3700K	R711	5055175244914

Retail Solutions

Part No	Description	Barcode
BU150	Ring Xenon150 counter top display unit c/w 8 x H7, 4 x H4	5055175241326



BU150

Scan to watch the video



*compared to standard halogen bulb

Vehicle Lighting

Performance Halogens 14



Xenon130

Brighter Headlamp

Puts up to 130%* more light on the road

- Improve night vision with up to 130% more light on the road for a safer and more comfortable journey
- Maximum performance is achieved through micro filament technology and 100% Xenon gas.
- See and be seen more clearly with up to a 60m longer beam than a standard bulb
- Better visibility of road markings and signs is produced through a whiter light that is closer to daylight
- A stylish finish is achieved through the silver tip
- No changes to vehicle wiring required

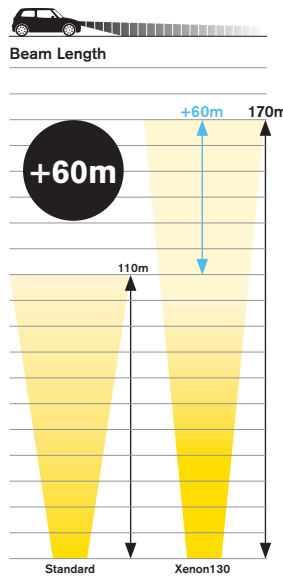

+130%

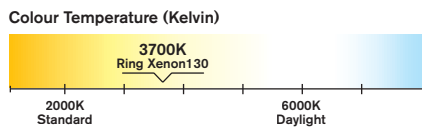
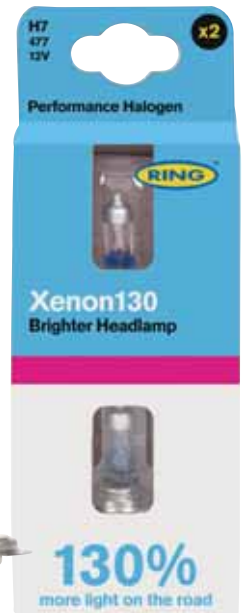

Twin

Part No	Voltage	Wattage	ECE	Cap	Kelvin	Upgrades	Barcode
RW3348	12V	55W	H1	P14.5s	3700K	R448	5055175239491
RW3372	12V	60/55W	H4	P43t	3700K	R472	5055175236957
RW3377	12V	55W	H7	PX26d	3700K	R477	5055175236964
RW3306	12V	51W	HB4	P22d	3700K	R9006	5055175239507
RW3311	12V	55W	H11	PGJ19-2	3700K	R711	5055175239514

Retail Solutions

Part No	Description	Barcode
BU5900	Ring Xenon130 counter top display unit c/w 8 x H7, 4 x H4	5055175237312



Scan to watch the video



*compared to standard halogen bulb

BU5900



XenonMax Brighter Headlamp

Puts up to 100%* more light on the road

- Xenon gas technology and precise filament for improved performance
- Increased light output allows other road users to be seen more clearly at a distance of 75m on dipped beam
- Provides better reflections from road markings and signs
- H4, H7, H11 and HB4 have silver caps to blend in with reflector when unlit
- No changes to wiring required

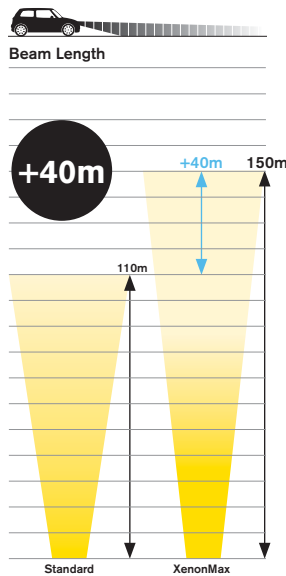

+100%

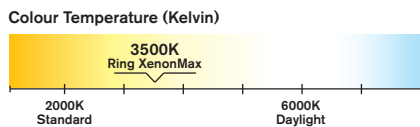
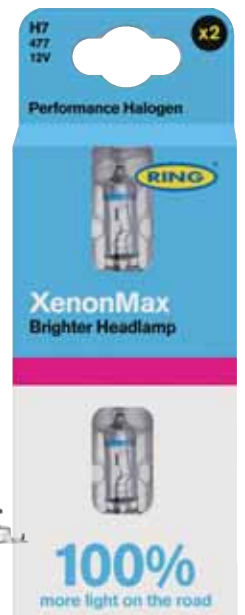

Twin

Part No	Voltage	Wattage	ECE	Cap	Kelvin	Upgrades	Barcode
RW1048	12V	55W	H1	P14.5s	3500K	R448	5055175214917
RW1053	12V	55W	H3	PK22s	3500K	R453	5055175221946
RW1072	12V	60/55W	H4	P43t	3500K	R472	5055175214344
RW1077	12V	55W	H7	PX26d	3500K	R477	5055175214351
RW1005	12V	60W	HB3	P20d	3500K	R9005	5055175217154
RW1006	12V	51W	HB4	P22d	3500K	R9006	5055175217161
RW1011	12V	55W	H11	PGJ19-2	3500K	R711	5055175217178

*compared to standard halogen bulb

Vehicle Lighting

Performance Halogens 16



UltraXenon Brighter Headlamp

Puts up to 60%* more light on the road

- Improved light output provides better reflections from road markings and signs
- Other road users can be seen more clearly at a distance of 75m on dipped beam
- No changes to wiring required

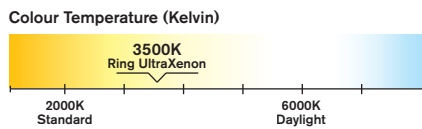
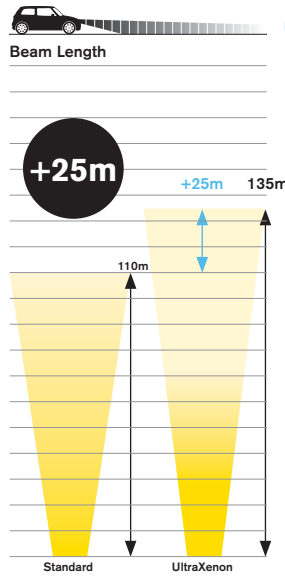

Twin

Part No	Voltage	Wattage	ECE	Cap	Kelvin	Upgrades	Barcode
RW948	12V	55W	H1	P14.5s	3500K	R448	5011274194826
RW972	12V	60/55W	H4	P43t	3500K	R472	5011274197223
RW977	12V	55W	H7	PX26d	3500K	R477	5011274197728
RW9905	12V	60W	HB3	P20d	3500K	R9005	5055175200583
RW9906	12V	51W	HB4	P22d	3500K	R9006	5055175200590

*H4 up to 60% brighter, H1 and H7 up to 50% brighter than a conventional headlamp bulb.



Xenon5000 Whiter Headlamp

The whitest road legal bulb

- Enhance the look of your vehicle
- Creates an LED headlamp look
- White light blends with LED DRL lamps
- Closer to daylight for a more comfortable night time drive
- See road signs and markings earlier with reflective white light
- Crisp white light and high power beam
- H4 and H7 references have stylish silver tip to blend into headlamp when unlit
- Puts up to 50%* more light on the road for safer and more comfortable night driving

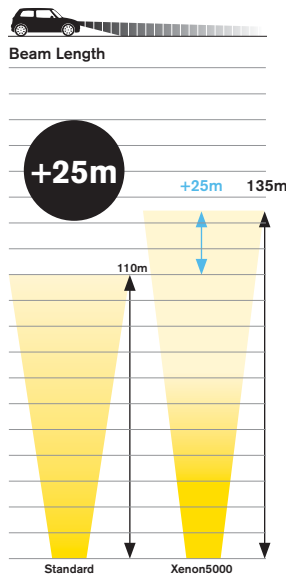

5000K

+50%

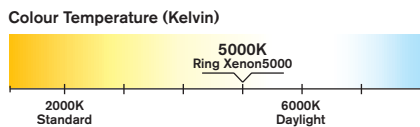
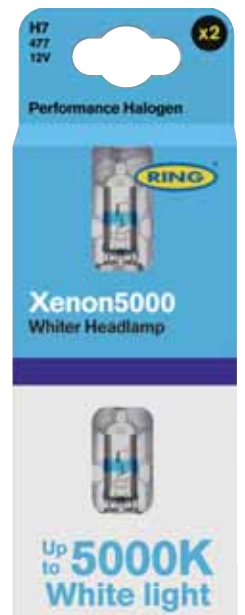

Twin

Part No	Voltage	Wattage	ECE	Cap	Kelvin	Upgrades	Barcode
RW5048	12V	55W	H1	P14.5s	5000K	R448	5055175243597
RW5072	12V	60/55W	H4	P43t	5000K	R472	5055175243573
RW5077	12V	55W	H7	PX26d	5000K	R477	5055175243580
RW5011	12V	55W	H11	PGJ19-2	5000K	R711	5055175243603

Scan to watch the video



*compared to standard halogen bulb

Vehicle Lighting

Performance Halogens 18



Xenon4400 Whiter Headlamp

Enhance the look of your vehicle

- Creates Xenon HID headlamp look
- Closer to daylight colour blends with DRL bulbs
- Puts up to 30%* more light on the road for safer night driving
- Crisp white light and power beam
- H4 and H7 references have stylish silver tip to blend into headlamp when unlit

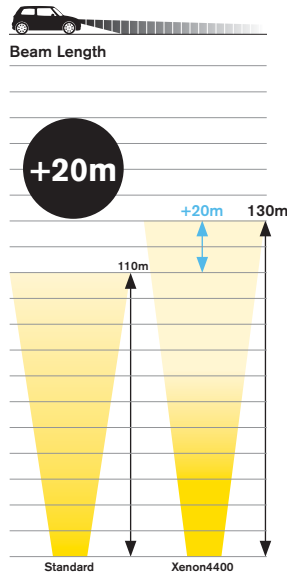

4400K

+30%

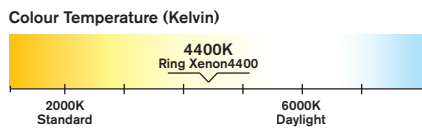

Twin

Part No	Voltage	Wattage	ECE	Cap	Kelvin	Upgrades	Barcode
RW4448	12V	55W	H1	P14.5s	4400K	R448	5055175235011
RW4472	12V	60/55W	H4	P43t	4400K	R472	5055175235028
RW4477	12V	55W	H7	PX26d	4400K	R477	5055175235035

Scan to watch the video



*compared to standard halogen bulb



Xenon4000 Whiter Headlamp

Enhance the look of your vehicle

- Crisp white light
- H4 and H7 references have stylish silver tip to blend into headlamp when unlit

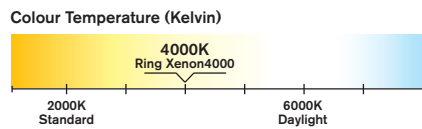
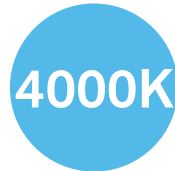
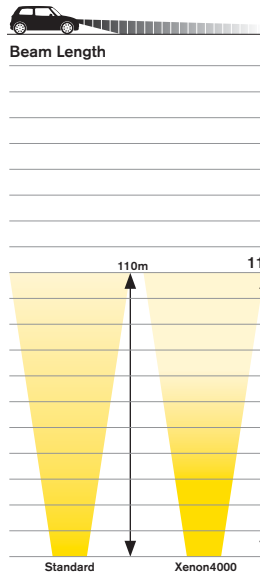

Twin

Part No	Voltage	Wattage	ECE	Cap	Kelvin	Upgrades	Barcode
RW4072	12V	60/55W	H4	P43t	4000K	R472	5055175229508
RW4077	12V	55W	H7	PX26d	4000K	R477	5055175229515

Vehicle Lighting

Performance Halogens 20



SportzBlue Whiter Headlamp

Off-road intense white light
with blue reflector hue

- Up to 3900K white light with a darker blue hint
- 80-100W produces a high power beam pattern
- H4 and H7 have a silver cap to blend in with reflector when unlit
- Ideal for off-roaders, sports and rally drivers
- Changes to wiring or fuses may be required
- Off road use only

3900K



Colour Temperature (Kelvin)

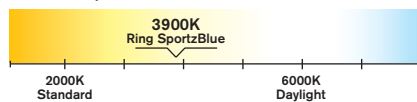

Twin

Part No	Voltage	Wattage	ECE	Cap	Kelvin	Upgrades	Barcode
RW668	12V	80W	H1	P14.5s	3900K	R448	5011274166823
RW684	12V	100/80W	H4	P43t	3900K	R472	5011274168421
RW664	12V	80W	H7	PX26d	3900K	R477	5011274166427



RallySport Brighter Headlamp

Off-road intense white light and high power beam

- 80-160W produces a high power beam pattern
- Off road use only
- Ideal for sport or rally drivers
- Changes to wiring or fuses may be required

3500K



Colour Temperature (Kelvin)

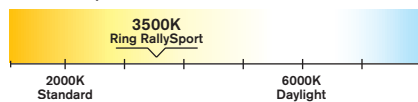

Twin

Part No	Voltage	Wattage	ECE	Cap	Kelvin	Upgrades	Barcode
RW481	12V	100W	H1	P14.5s	3500K	R448	5011274094973
RW499	12V	130W	H1	P14.5s	3500K	R448	5011274095000
RW483	12V	100W	H3	PK22s	3500K	R453	5011274094980
RW492	12V	130W	H3	PK22s	3500K	R453	5011274095017
RW473	12V	100/55W	H4	P43t	3500K	R472	5011274094966
RW484	12V	100/80W	H4	P43t	3500K	R472	5011274148423
RW490	12V	130/90W	H4	P43t	3500K	R472	5011274095000
RW590	12V	160/90W	H4	P43t	3500K	R472	5011274159030
RW464	12V	100W	H7	PX26d	3500K	R477	5055175201306

Vehicle Lighting



Whiter Sidelights

- Designed to 'colour match' headlamp upgrade bulbs
- Create a whiter look by upgrading your sidelight bulbs to match the latest performance halogen upgrade bulbs
- Whiter bulbs will enhance the look of your vehicle particularly those with Daytime Running Lights

Upgrade to a stylish look

- Direct replacement for existing bulbs
- Optional plug and play resistor kit for vehicles with bulb failure warning system (LED501RES / LED382RES)
- Off road or internal use only

Colour Temperature (Kelvin)

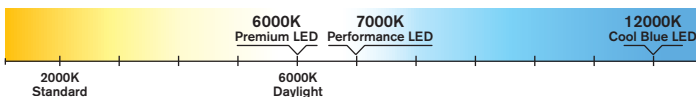

12V Bulbs - Boxed

Part Number	Bulb Ref	Bulb Type	Application	Colour Temp	Lumens	More Info	Barcode
R801	501	W5W	Sidelight	3400K			5011274080105
R833	233	T4W	Sidelight	3400K			5011274083304
R1401	501	W5W	Sidelight	3500K			5055175244945

12V Bulbs - Blister packed

Part Number	Bulb Ref	Bulb Type	Application	Colour Temp	Lumens	More Info	Barcode
RW801	501	W5W	Sidelight	3400K			5011274180126
RW833	233	T4W	Sidelight	3400K			5011274183325
RW1401	501	W5W	Sidelight	3500K			5055175231952
RW882	582	W21W	Sidelight	4000K			5055175244952
RW888	580	W21/5W	Sidelight	4000K			5055175244976

12V LEDs - Blister packed

Part Number	Bulb Ref	Bulb Type	Application	Colour Temp	Lumens	More Info	Barcode
RW2396LED	239	C5W	Number Plate & Interior	6000K	35	39mm White	5055175229553
RW23912LED	239	C5W	Number Plate & Interior	12000K	35	39mm Blue	5055175232492
RW5016LED	501	W5W	Sidelight & Interior	6000K	40	White	5055175229546
RW50112LED	501	W5W	Sidelight & Interior	12000K	35	Blue	5055175232485
LED501RES		W5W/W3W				LED Resistor kit for W5W	5055175227627



Optimised light output

- Filament technology gives a uniform light output, just like a standard bulb
- Up to 6000K bulbs
- Longer life
- Vibration resistant
- Designed to replace a standard bulb
- Off road or internal use only



12V Filament Style LEDs - Blister packed

Part Number	Bulb Ref	Bulb Type	Application	Colour Temp	Lumens	More info	Barcode
RW2073FSLED	207	R5W	Side & Tail	3000K	60		5055175239644
RW2336FSLED	233	T4W	Side & Tail	6000K	40		5055175239668
RW2396FSLED	239	C5W	Number Plate & Interior	6000K	45	CANbus Technology	5055175239675
RW2453FSLED	245	R10W	Side & Tail	3000K	125		5055175239651
RW3803FSLED	380	P21/5W	Brake/Tail	3000K	380/40	Nichia LED	5055175240374
RW3823FSLED	382	P21W	Brake & Indicator	3000K	390	Nichia LED	5055175240381
RW5016FSLED	501	W5W	Side & Interior	6000K	60	CANbus Technology	5055175239682
RW501AFSLED	501A	WY5W	Side Repeater	2000K	40	Amber	5055175240404
RW581AFSLED	581	PY21W	Indicator	2000K	280	Nichia LED & Amber	5055175240398
RW589AFSLED	589	RY10W	Indicator	2000K	75	Amber	5055175240411

24V Filament Style LEDs - Boxed

Part Number	Bulb Ref	Bulb Type	Application	Colour Temp	Lumens	More Info	Barcode
RB1493FSLED	149	R5W	Side & Tail	3000K	55		5055175240428
RB1506FSLED	150	R5W	Side & Tail	6000K	55		5055175240589
RB2413FSLED	241	P21W	Brake & Indicator	3000K	395	Nichia LED	5055175240503
RB2426FSLED	242	C5W	Number Plate & Interior	6000K	50		5055175240541
RB2463FSLED	246	R10W	Side & Tail	3000K	110		5055175240442
RB2496FSLED	249	T4W	Side & Tail	6000K	45		5055175240480
RB2943FSLED	294	P21/5W	Brake/Tail	3000K	410/55	Nichia LED	5055175240527
RB3463FSLED	346	P21W	Brake & Indicator	3000K	395	Nichia LED	5055175240602
RB5076FSLED	507	W5W	Side, Tail & Interior	6000K	65		5055175240466

Vehicle Lighting



LED bulbs for a whiter look

- Latest CANbus technology
- Up to 6000K bulbs
- Longer life
- Vibration resistant
- Extra bright
- Off road or internal use only



Colour Temperature (Kelvin)

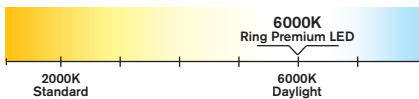

12V Premium LEDs - Display Box

Part Number	Bulb Ref	Bulb Type	Application	Colour Temp	Lumens	More Info	Barcode
RW207LED	207/245	R5W/R10W	Signalling	6000K	400		5055175237091
RW239CBLED	239	C5W	Number Plate & Interior	6000K	200	CANbus Technology	5055175237060
RW380LED	380	P21/5W	Signalling	6000K	510/150		5055175237039
RW382LED	382	P21W	Signalling	6000K	530		5055175237046
RW477FLED	477	H7	Fog Lamp only	6000K	600		5055175237022
RW501CBLED	501	W5W	Side & Interior	6000K	220	CANbus Technology	5055175237053
RW711FLED	711	H11	Fog Lamp only	6000K	600		5055175237015

24V Premium LEDs - Display Box

Part Number	Bulb Ref	Bulb Type	Application	Colour Temp	Lumens	More Info	Barcode
RB1496LED	149	R5W	Signalling	6000K	400		5055175237268
RB1506LED	150	R5W	Signalling	6000K	400		5055175237275
RB2416LED	241	P21W	Signalling	6000K	530		5055175237282
RB2426LED	242	C5W	Number Plate & Interior	6000K	200	CANbus Technology	5055175237244
RB2496LED	249	T4W	Signalling	6000K	200		5055175237299
RB5076LED	507	W5W	Side & Interior	6000K	220	CANbus Technology	5055175237251



LED bulbs for a whiter look

- 3D technology
- Up to 7000K bulbs
- Longer life
- Vibration resistant
- Extra bright
- Off road or internal use only

Colour Temperature (Kelvin)

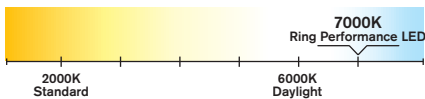

270° Light distribution

3D Technology

Many LED designs are '2D'. 2D LEDs have a flat surface forcing the light to be emitted in one direction only. This can be a problem with LEDs, as no matter how many other LEDs are added to the lamp in any position, the light distribution may be uneven. Our 3D LEDs are made with a flexible LED beading which can be used to simulate the shape of a standard bulb thus giving an even light distribution.

12V Performance LEDs - Display Box

Part Number	Bulb Ref	Bulb Type	Application	Colour Temp	Lumens	More Info	Barcode
RW380DLED	380	P21/5W	Signalling	7000K	300/100	3D Technology	5055175237077
RW382DLED	382	P21W	Signalling	7000K	560	3D Technology	5055175237084
RW501DLED	501	W5W	Side & Interior	7000K	200	3D Technology	5055175237107

Vehicle Lighting

Silver Enigma 26



Standard Indicator Bulb Amber unlit



SilverEnigma Bulb Red lit



SilverEnigma Indicator Bulb unlit



SilverEnigma Bulb unlit



SilverEnigma Styling Bulb

Flashes amber, looks clear when unlit

- Flashes amber and provides a clear integrated look when unlit
- Ring SilverEnigma is interchangeable with conventional bulbs
- Upgrades R581 amber indicator bulb



Illuminates red, looks clear when unlit

- Illuminates red and provides a clear integrated look when unlit
- Vehicle Specific OE replacement bulb
- Upgrades R782 stop light bulb
- Upgrades R780 stop and tail bulb



Boxed

Part No	Voltage	Wattage	ECE	Cap	Upgrades	Barcode
R3782	12V	21W	PR21W	BAW15s	R782	5055175215013
R3780	12V	21/5W	PR21/5W	BAW15d	R780	5055175215020

Blister packed

Part No	Voltage	Wattage	ECE	Cap	Upgrades	Barcode
RW3581	12V	21W	PY21W	BAU15s	R581	5011274168414
RW3782	12V	21W	PR21W	BAW15s	R782	5055175243689
RW3780	12V	21/5W	PR21/5W	BAW15d	R780	5055175243696



Designed for today's modern headlamp units

- Optimise the efficiency of lighting equipment with Ring Premium headlamp bulbs
- The output and efficiency of vehicle headlamps is not only determined by the shape, size and manufacturing quality of the reflector but also the quality of the bulb
- Smaller headlamp designs require a bulb with a more precise filament position



Ring Premium Headlamp Bulb Range – Single Blister

Part Number	Voltage	Wattage	ECE	Cap	Barcode
RU448EQ	12V	55W	H1	P14.5s	5011274184414
RU472EQ	12V	60/55	H4	P43t	5055175201016
RU477EQ	12V	55	H7	PX26d	5055175201030

Ring Premium Headlamp Bulb Range – Twin Blister

Part Number	Voltage	Wattage	ECE	Cap	Barcode
RW448EQ	12V	55W	H1	P14.5s	5011274144845
RW472EQ	12V	60/55W	H4	P43t	5055175201030
RW477EQ	12V	55W	H7	PX26d	5055175201047

Vehicle Lighting

OE Xenon HID 28



- Ring Xenon HID bulbs are OE manufactured
- Direct OE replacement for existing discharge bulb
- Long life – 3000 hours
- E Approved / Road legal

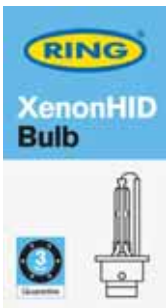
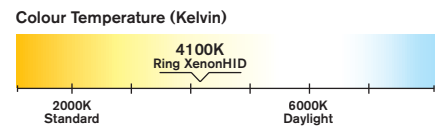

4100K
Standard colour temperature

Ring Xenon HID - Boxed

Part Number	Voltage	Wattage	ECE	Cap	Barcode
R85406	85V	35W	D1R	PK32d-3	5055175215129
R85402	85V	35W	D1S	PK32d-2	5055175215112
R85126	85V	35W	D2R	P32d-3	5055175211480
R85122	85V	35W	D2S	P32d-2	5055175211473
R42306	42V	35W	D3R	PK32d-6	5055175235882
R42302	42V	35W	D3S	PK32d-5	5055175230610
R42406	42V	35W	D4R	P32d-6	5055175235899
R42402	42V	35W	D4S	P32d-5	5055175230627
R12410	12/24V	25W	D5S	PK32d-7	5055175239903
R66548	12V	25W	D8S	PK32d-1	5055175243719

Ring Xenon HID - Blister packed

Part Number	Voltage	Wattage	ECE	Cap	Barcode
RU85406	85V	35W	D1R	PK32d-3	5055175220239
RU85402	85V	35W	D1S	PK32d-2	5055175220222
RU85126	85V	35W	D2R	P32d-3	5055175220215
RU85122	85V	35W	D2S	P32d-2	5055175220208
RU42302	42V	35W	D3S	PK32d-5	5055175242903
RU42402	42V	35W	D4S	P32d-5	5055175242910

Fitting Video

Scan to watch the video



All Ring HID bulbs are Lead free.
All Ring D3 and D4 bulbs are Mercury free.



- Ring Xenon HID bulbs are OE manufactured
- 20% more light than a standard HID bulb
- 5500K colour temperature for a whiter light
- Long life – 3000 hours
- E Approved / Road legal

5500K
High colour temperature

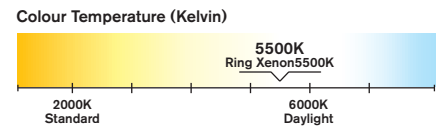

Ring Xenon HID 5500K - Boxed

Part Number	Voltage	Wattage	ECE	Cap	Barcode
R854025K	85V	35W	D1S	PK32d-2	5055175237619
R851265K	85V	35W	D2R	P32d-3	5055175237589
R851225K	85V	35W	D2S	P32d-2	5055175237572
R423025K	42V	35W	D3S	PK32d-5	5055175244211
R424025K	42V	35W	D4S	P32d-5	5055175244228

Ring Xenon HID 5500K - Blister packed

Part Number	Voltage	Wattage	ECE	Cap	Barcode
RU854025K	85V	35W	D1S	PK32d-2	5055175237824
RU851265K	85V	35W	D2R	P32d-3	5055175237817
RU851225K	85V	35W	D2S	P32d-2	5055175237800
RU423025K	42V	35W	D3S	PK32d-5	5055175243535
RU424025K	42V	35W	D4S	P32d-5	5055175243542



- Ring Xenon HID bulbs are OE manufactured
- 100% more light on the road ahead
- 4100K colour temperature
- Long life – 3000 hours
- E Approved / Road legal

+100%
More light on the road

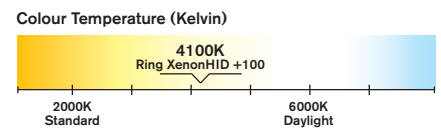

Ring Xenon HID +100% - Boxed

Part Number	Voltage	Wattage	ECE	Cap	Barcode
R85402100	85V	35W	D1S	PK32d-2	5055175244617
R85122100	85V	35W	D2S	P32d-2	5055175244624

Ring Xenon HID +100% - Blister packed

Part Number	Voltage	Wattage	ECE	Cap	Barcode
RU85402100	85V	35W	D1S	PK32d-2	5055175543559
RU85122100	85V	35W	D2S	P32d-2	5055175243566

Vehicle Lighting

Long Life Bulbs 30



Lasts up to 3x longer than the standard equivalent bulb

- Ideal for day and night use and high mileage drivers
- Improved resistance to vehicle overvoltage
- Suitable for vehicles with optional 'lights on' function or daytime running systems



Coping with Overvoltage

On many of today's modern vehicles the measured voltage can be higher than 12V in order to cope with the additional electronic devices and electric motors.

Bulbs for cars are currently manufactured to operate at 12V and tested at 13.2V however, if the constant running voltage is higher than this it can result in a rapid decrease in the life expectancy of the bulb. Ring Automotive's Long Life bulbs provide a better resistance to vehicle overvoltage.

Blister packed

Part Number	Voltage	Wattage	ECE	Cap	Barcode
RU477LL	12V	55W	H7	PX26d	5011274147747
RU472LL	12V	60/55W	H4	P43t	5011274147242
RU448LL	12V	55W	H1	P14.5s	5011274144852
RU453LL	12V	55W	H3	PK22s	5011274045333
RU711LL	12V	55W	H11	PGJ19-2	5055175243610
RW380LL	12V	21/5W	P21/5W	BAY15d	5011274138042
RW382LL	12V	21W	P21W	BA15s	5011274138240
RW207LL	12V	5W	R5W	BA15s	5011274120740
RW245LL	12V	10W	R10W	BA15s	5011274124540
RW501LL	12V	5W	W5W	W2.1x9.5d	5011274250195
RW239LL	12V	5W	C5W	S8.5d 11x38mm	5011274123949
RW581LL	12V	21W	PY21W	BAU15s	5011274158149
RW233LL	12V	4W	T4W	BA9s	5011274123345

*Headlamps only



Gain time, gain distance, avoid rear end collisions

- Faster light-up* and greater light intensity provides earlier warning to following vehicles
- A shorter, more precise filament produces up to **20% more luminance** than a standard bulb
- Up to 3 metres** extra stopping distance



Twin blister packed

Part No	Voltage	Wattage	ECE	Cap	Upgrades	Barcode
RW380RR	12V	21/5W	P21/5W	BAY15d	R380	5055175215303
RW382RR	12V	21W	P21W	BA15s	R382	5055175215310
RW207RR	12V	5W	R5W	BA15s	R207	5055175215327
RW245RR	12V	10W	R10W	BA15s	R245	5055175215334

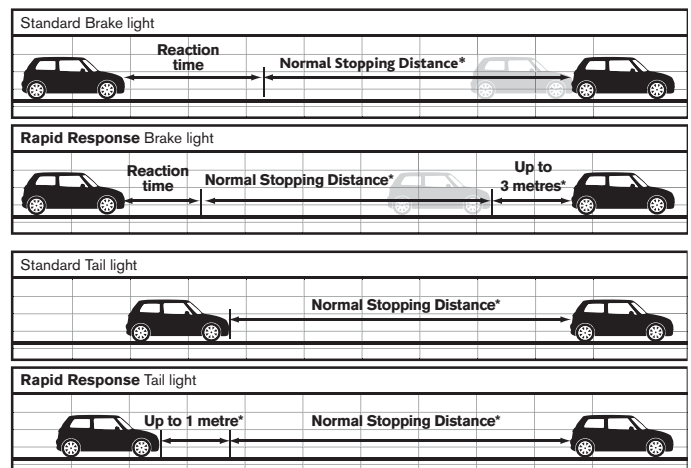

*Based on travelling speeds of 62mph

*Faster light applies to brake and tail, and brake, tail and indicator bulbs only.
 **Up to 3 metres applies to brake and tail and brake bulbs only.

Vehicle Lighting



Retail Blister Packs - Profit makers

Twin packed blister bulbs offer a greater profit making opportunity than single blister, especially as a consumer is less likely to shop around when selecting a replacement bulb which is normally an emergency purchase.

In addition as the footprint of the card is the same it will yield more profit per linear foot than a single pack.

RW= 
Twin Blister Pack

RU= 
Single Blister Pack

Single Blister Pack

Twin Blister Pack

- ECE Ref → H7
- Part Number → 477
- Voltage → 12V
- Bulb type → Headlamp



- ECE Ref → P21W
- Part Number → 382
- Voltage → 12V
- Bulb type → Rapid Response Brake/indicator



Additional information to aid decision making

Colour coded to highlight range →

Hints and tips on changing the bulb



Barcode



12V Single Bulb Blister Pack Headlamps

12V Twin Packs

Part No	Voltage	Wattage	ECE	Cap	Application	Colour	Pack Qty	Barcode	Ref	Pack Qty	Barcode
RU12	12V	60/55W	(H4)**	P45t			10 x 1	5011274101213			
RU410	12V	45/40W	R2 ASY	P45t			10 x 1	5011274141011			
RU448	12V	55W	H1	P14.5s			10 x 1	5011274144814			
RU453	12V	55W	H3	PK22s			10 x 1	5011274145316	RW453	10 x 1	5055175209739
RU472	12V	60/55W	H4	P43t			10 x 1	5011274147211	RW472	10 x 1	5011274147273
RU477	12V	55W	H7	PX26d			10 x 1	5011274147716	RW477	10 x 1	5011274147723
RU479	12V	55W	H2	X511			10 x 1	5011274147969			
RU480	12V	100W	(H2)**	X511			10 x 1	5011274148010			
RU491	12V	130W	(H2)**	X511			10 x 1	5011274149161			
RU708	12V	35W	H8	PGJ19-1			10 x 1	5011274170813			
RU709	12V	65W	H9	PGJ19-5			10 x 1	5011274057091			
RU711	12V	55W	H11	PGJ19-2			10 x 1	5011274057114			
RU715	12V	55/15W	H15	PGJ23t-1			10 x 1	5055175217536			
RU716	12V	19W	H16	PGJ19-3			10 x 1	5055175243740			
RU880	12V	27W	H27W/1	PG13			10 x 1	5011274188016			
RU881	12V	27W	H27W/2	PGJ13			10 x 1	5011274188115			
RU9005	12V	60W	HB3	P20d			10 x 1	5011274190538			
RU9006	12V	51W	HB4	P22d			10 x 1	5011274090067			
RU9012	12V	55W	HIR2	PX22d			10 x 1	5055175243627			

12V Single Bulb Blister Pack Exterior/Interior

12V Twin Packs

Part No	Voltage	Wattage	ECE	Cap	Application	Colour	Pack Qty	Barcode	Ref	Pack Qty	Barcode
RU180	12V	27/7W	P27/7W	W2.5x16q			10 x 1	5011274118013			
RU182	12V	27W	P27W	W2.5x16d			10 x 1	5011274118211			
RU183	12V	27/7W	PY27/7W	WX2.5x16q			10 x 1	5011274018368			
RU207	12V	5W	R5W	BA15s			10 x 1	5011274120719	RW207	10 x 1	5011274120726
RU209	12V	5W	R5W	BA15d			10 x 1	5011274120917	RW209	10 x 1	5011274120924
RU233	12V	4W	T4W	BA9s			10 x 1	5011274123314	RW233	10 x 1	5011274123321
RU237	12V	7W		S8.5d 10x40mm		Frosted	10 x 1	5011274123710	RW237	10 x 1	5011274123727
RU239	12V	5W	C5W	S8.5d 11x38mm			10 x 1	5011274123918	RW239	10 x 1	5011274123925
RU245	12V	10W	R10W	BA15s			10 x 1	5011274124519	RW245	10 x 1	5011274124526
RU256	12V	3W		S7d 8x38mm			10 x 1	5011274125615	RW256	10 x 1	5011274125622
RU264	12V	10W		S8.5d 11x44mm			10 x 1	5011274126414	RW264	10 x 1	5055175202518
RU265	12V	10W		S8.5d 15x44mm			10 x 1	5011274126513			
RU269	12V	10W		S8.5d 11x30mm			10 x 1	5011274126919	RW269	10 x 1	5011274126933
RU958	12V	16W	WY16W	W2.1x9.5d		Amber	10 x 1	5055175243634			

*Headlamps only **Off road use only

Vehicle Lighting









12V Single Bulb Blister Pack Exterior/Interior (continued)

12V Twin Packs





















Part No	Voltage	Wattage	ECE	Cap	Application	Colour	Pack Qty	Barcode	Ref	Pack Qty	Barcode
RU270	12V	18W		S8.5d 15x44mm			10 x 1	5011274127015			
RU272	12V	10W		S8.5d 11x38mm			10 x 1	5011274127213	RW272	10 x 1	5011274127206
RU273	12V	21W		S8.5d 15x44mm			10 x 1	5011274127312	RW273	10 x 1	5011274127329
RU280	12V	1.5W		LES E5/8			10 x 1	5011274128012			
RU281	12V	2W		BA7s			10 x 1	5011274128111	RW281	10 x 1	5011274128128
RU284	12V	2.3W	W2.3W	W2x4.6d			10 x 1	5011274128425	RW284	10 x 1	5011274128432
RU286	12V	1.2W		W2x4.6d			10 x 1	5011274128616	RW286	10 x 1	5011274128623
RU286A	12V	1.2W		W2x4.6d		Amber	10 x 1	5011274128517			
RU286G	12V	1.2W		W2x4.6d		Green	10 x 1	5011274128654	RW286G	10 x 1	5055175203201
RU286R	12V	1.2W		W2x4.6d		Red	10 x 1	5011274128531			
RU297	12V	2.2W		W2.1x9.5d			10 x 1	5011274129712	RW297	10 x 1	5055175203188
RU32/3	12V	32/4W		BAY15d			10 x 1	5011274132316			
RU335	12V	21W	P21W	BA15d			10 x 1	5011274133511	RW335	10 x 1	5011274133528
RU343	12V	21W		BA15s		Amber	10 x 1	5011274134365			
RU380	12V	21/5W	P21/5W	BAY15d			10 x 1	5011274138011	RW380	10 x 1	5011274138028
RU382	12V	21W	P21W	BA15s			10 x 1	5011274138219	RW382	10 x 1	5011274138226
RU433	12V	20W		BA9s			10 x 1	5011274143312			
RU434	12V	6W	H6W	BAX9s			10 x 1	5011274143411	RW434	10 x 1	5055175202532
RU435	12V	21W	H21W	BAY9s			10 x 1	5011274143510			
RU501	12V	5W	W5W	W2.1x9.5d			10 x 1	5011274150112	RW501	10 x 1	5011274150129
RU501A	12V	5W	WY5W	W2.1x9.5d		Amber	10 x 1	5011274150181	RW501A	10 x 1	5011274151195
RU504	12V	3W	W3W	W2.1x9.5d			10 x 1	5011274150419	RW504	10 x 1	5011274150426
RU509T	12V	1.2W		B8.5D		Black base	10 x 1	5011274150914	RW509T	10 x 1	5055175202549
RU509TBBK	12V	1.2W		B8.3D		Black base	10 x 1	5011274150990			
RU509TGR	12V	2W		BX8.5D		Green base	10 x 1	5011274150945			
RU509TMBE	12V	1.5W		BX8.4D		Beige Base	10 x 1	5011274150938			
RU509TMBK	12V	1.2W		BX8.4D		Black base	10 x 1	5011274150921			
RU509TML	12V	1.2W		B8.4D		Blue Base	10 x 1	5011274290528			
RU509TMGR	12V	2W		BX8.4D		Green base	10 x 1	5011274290542			
RU509TMOR	12V	1.12W		BX8.4D		Orange base	10 x 1	5011274150983			
RU509TOR	12V	1W		BX8.5D		Orange base	10 x 1	5011274290535			
RU509TWGY	12V	1.2W		B8.7D		Grey base	10 x 1	5011274290559			
RU512PCB	12V	2CP		P.C.B 10mm			10 x 1	5011274151218			
RU512TR	12V	2CP		B12.3d 10mm			10 x 1	5011274151225			
RU512WB	12V	2W		Kw2.1x9.5D		White base	10 x 1	5011274151232			
RU566	12V	21/4W	P21/4W	BAZ15d			10 x 1	5011274156619	RW566	10 x 1	5011274156626
RU580	12V	21/5W	W21/5W	W3x16q			10 x 1	5011274158064	RW580	10 x 1	5055175202525
RU581	12V	21W	PY21W	BAU15s		Amber	10 x 1	5011274158118	RW581	10 x 1	5011274158132
RU582	12V	21W	W21W	W3x16d			10 x 1	5011274158262			
RU585	12V	21W	WY21W	W3x16d		Amber	10 x 1	5011274158514	RW585	10 x 1	5011274158521
RU64122	12V	3W		B10D		Brown base	10 x 1	5011274164126			
RU64124	12V	5W		B10D		Black base	10 x 1	5011274164133			
RU643	12V	2.2W		BA9s			10 x 1	5011274164317			
RU780	12V	21/5W	PR21/5W	BAW15d		Red	10 x 1	5055175220581			
RU782	12V	21W	PR21W	BAW15s		Red	10 x 1	5055175220598			
RU955	12V	16W	W16W	W2.1x9.5d T15			10 x 1	5011274195526			
RU987	12V	2.2W		E10/13			10 x 1	5011274198718	RW987	10 x 1	5011274198725
RU989	12V	5W		BA9s			10 x 1	5011274198916	RW989	10 x 1	5011274198923

12V International Single Clamshell Pack Headlamps



12V International Twin

Part No	Voltage	Wattage	ECE	Cap	Application	Type	Pack Qty	Barcode	Ref	Pack Qty Barcode
REU448	12V	55W	H1	P14.5s			10 x 1	5055175200699		
REU448LL	12V	55W	H1	P14.5s		Long Life	10 x 1	5055175227023		
REU453	12V	55W	H3	PK22s			10 x 1	5055175200804		
REU472	12V	60/55W	H4	P43t			10 x 1	5055175200668	REW472	1 x 10 5055175227764
REU472LL	12V	60/55W	H4	P43t		Long Life	10 x 1	5055175226552		
REU477	12V	55W	H7	PX26d			10 x 1	5055175200675	REW477	1 x 10 5055175227771
REU477LL	12V	55W	H7	PX26d		Long Life	10 x 1	5055175226569		
REU9005	12V	60W	HB3	P20d			10 x 1	5055175226538		
REU9006	12V	51W	HB4	P22d			10 x 1	5055175226545		

12V International Double Clamshell Pack Exterior/Interior

Part No	Voltage	Wattage	ECE	Cap	Application	Type	Pack Qty	Barcode
REW207S	12V	5W	R5W	BA15s			10 x 1	5055175200682
REW209	12V	5W	R5W	BA15d			10 x 1	5055175200866
REW233	12V	4W	T4W	BA9s			10 x 1	5055175200743
REW239	12V	5W	C5W	S8.5d 11x38mm			10 x 1	5055175200729
REW245S	12V	10W	R10W	BA15s			10 x 1	5055175200712
REW264	12V	10W		S8.5d 11x44mm			10 x 1	5055175200781
REW269	12V	10W		S8.5d 11x30mm			10 x 1	5055175200774
REW272	12V	10W		S8.5d 11x38mm			10 x 1	5055175200811
REW286	12V	1.2W		W2x4.6d			10 x 1	5055175200736
REW297	12V	2.2W		W2.1x9.5d			10 x 1	5055175200798
REW335	12V	21W	P21W	BA15d			10 x 1	5055175200828
REW343	12V	21W		BA15s		Amber	10 x 1	5055175200873
REW380	12V	21/5W	P21/5W	BAY15d			10 x 1	5055175200644
REW382	12V	21W	P21W	BA15s			10 x 1	5055175200637
REW501	12V	5W	W5W	W2.1x9.5d			10 x 1	5055175200651
REW501A	12V	5W	W5W	W2.1x9.5d		Amber	10 x 1	5055175200859
REW504	12V	3W	W3W	W2.1x9.5d			10 x 1	5055175200842
REW509T	12V	1.2W		B8.5D		Black base	10 x 1	5055175200767
REW566	12V	21/4W	P21/4W	BAZ15d			10 x 1	5055175200750
REW580	12V	21/5W	W21/5W	W3x16q			10 x 1	5055175200835
REW581	12V	21W	PY21W	BAU15s		Amber	10 x 1	5055175200705

24V Blister Packs

Part No	Voltage	Wattage	ECE	Cap	Application	Colour	Pack Qty	Barcode
RW149	24V	5W	R5W	BA15s			10 x 1	5011274114946
RW150	24V	5W	R5W	BA15d			10 x 1	5011274115012
RW241	24V	21W	P21W	BA15s			10 x 1	5011274124113
RW242	24V	5W	C5W	S8.5d 11 x 38mm			10 x 1	5011274124212
RW246	24V	10W	R10W	BA15s			10 x 1	5055175230078
RW249	24V	4W	T4W	BA9s			10 x 1	5011274124915
RW346	24V	21W	P21W	BA15d			10 x 1	5011274134617
RU466	24V	70W	H1	P14.5s			10 x 1	5055175230108
RU474	24V	70W	H7	PX26d			10 x 1	5055175230061
RU475	24V	75/70W	H4	P43t			10 x 1	5011274323073
RW505	24V	3W	W3W	W2.1x9.5d			10 x 1	5055175230085
RW507	24V	5W	W5W	W2.1x9.5d			10 x 1	5055175230092
RW508	24V	1.2W		W2x4.6d			10 x 1	5011274150815
RW508T	24V	1.2W		B8.5d		Grey base	10 x 1	5011274150822
RW588	24V	21W	PY21W	BAU15s		Amber	10 x 1	5055175230115

Vehicle Lighting



Essentials Range

A range of fast moving bulbs and consumables for forecourts

- Bulbs are one of the highest profit makers in the auto aftermarket
- Essential distress purchase and expected to be stocked in a forecourt
- Bulbs in a tamper proof packaging to prevent pilfering
- Planogram service available



50 cm wide x 56cm high

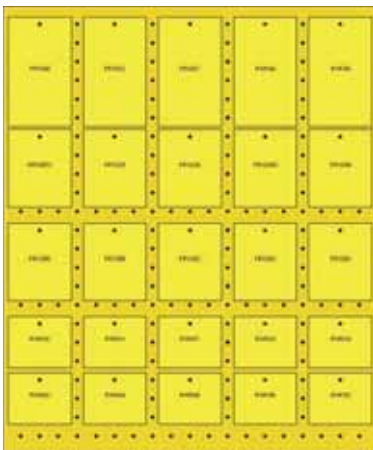

A = 8.5cm x 7cm



B = 8.5cm x 10.5cm



C = 8.5cm x 14.7cm



D = 8.5cm x 14.7cm

*Headlamps only

Essentials Bulbs

Part Number	Voltage	Wattage	ECE	Cap	Applications	Colour	Pack size	Pack Qty	Barcode
FRU448	12V	55W	H1	P14.5s			C	10 x 1	5055175210438
FRU472	12V	60/55W	H4	P43t			C	10 x 1	5055175210414
FRU477	12V	55W	H7	PX26d			C	10 x 1	5055175210421
FRW207	12V	5W	R5W	BA15s			B	10 x 1	5055175210476
FRW233	12V	4W	T4W	BA9s			B	10 x 1	5055175210520
FRW239	12V	5W	C5W	S8.5d 11x38mm			B	10 x 1	5055175210506
FRW245	12V	10W	R10W	BA15s			B	10 x 1	5055175210490
FRW286	12V	1.2W		W2x4.6d			B	10 x 1	5055175210513
FRW380	12V	21/5W	P21/5W	BAY15d			B	10 x 1	5055175210452
FRW382	12V	21W	P21W	BA15s			B	10 x 1	5055175210445
FRW501	12V	5W	W5W	W2.1x9.5d			B	10 x 1	5055175210469
FRW581	12V	21W	PY21W	BAU15s		Amber	B	10 x 1	5055175210483



Essentials Consumables

A range of fast moving automotive consumables including fuses, tape and connectors

Part Number	Description	Pack size	Pack Qty	Barcode
RAP010	Assorted Blade Fuses 15, 20, 25, 30 Amp	A	10 x 1	5011274901011
RAP011	Assorted Blade Fuses 3, 5, 7.5, 10 Amp	A	10 x 1	5011274901110
RAP017	Assorted Mini Blade Fuses 2, 4, 5, 7.5 Amp	A	10 x 1	5011274901714
RAP018	Assorted Mini Blade Fuses 10, 15, 20, 25 Amp	A	10 x 1	5055175210537
RAP019	Cable Connectors	A	10 x 1	5055175210544
RAP025	Assorted Ceramic Fuses, 5, 8, 16, 25 Amp	A	10 x 1	5011274902513
RAP034	Assorted Glass Fuses 10, 15, 25, 35 Amp	A	10 x 1	5011274903411
RAP038	Assorted Mains 240V Fuses, 3, 5, 13 Amp	A	10 x 1	5011274903817
RAP530	Mirror Fixing Pads	A	10 x 1	5011274953010
RAP532	Plastic Valve Caps	A	10 x 1	5011274953218
RAP544	Assorted Hose Clips	D	10 x 1	5011274954413
RAP545	PVC Insulation Tape	D	10 x 1	5011274954512

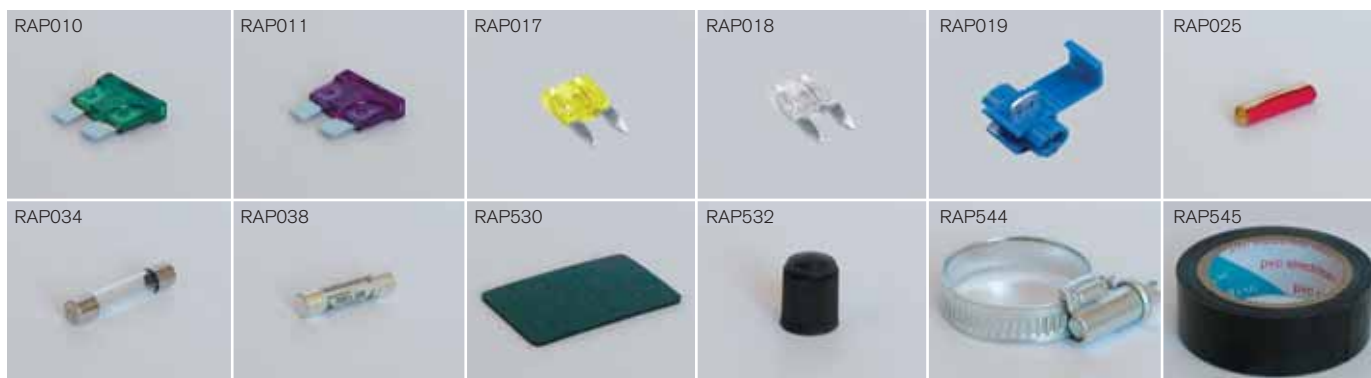

Vehicle Lighting



12V Auto Bulb Kits

- A compact kit that fits into the glove compartment
 - All bulbs are E approved as required
 - Mandatory in many European countries
 - Range covers all popular vehicle types
 - All bulbs can be replaced
 - Contains bulbs for headlamps and exterior lighting
 - UV cut headlamp bulbs suitable for plastic headlamps
- Don't leave home without one!



Universal Multi Headlamp 12V Auto Bulb Kit

- Suitable for vehicles fitted with H4, H1 or H7 headlamp bulbs
- 3 headlamp bulbs
- 12 additional bulbs
- 4 blade fuses
- Transferable from vehicle to vehicle



BU027

Mini 12V Auto Bulb Kit

- Compact kit for easy storage
- Contains major bulbs for exterior lighting plus fuses
- Universal kit contains 3 headlamps



*Headlamps only

Universal Standard 12V Auto Bulb Kits

Part Number	Suitable For Vehicles Fitted With:	Headlamp Bulbs	Additional Bulbs	Fuses	Barcode
BU007	H4 (R472) Headlamp Bulbs	1	9	3	5011274000745
BU008	H1 (R448) Headlamp Bulbs	1	9	3	5011274000806
BU077	H7 (R477) Headlamp Bulbs	1	9	3	5011274007706
BU031	HB3 (R9005) Headlamp Bulbs	1	10	3	5011274031114
BU041	HB4 (R9006) Headlamp Bulbs	1	10	3	5011274041113
BU042	HB3 (R9005) & HB4 (R9006) Headlamp Bulbs	2	10	3	5011274042226
BU072	H4 (R472) Headlamp Bulbs plus wedge base bulbs for Japanese vehicles	1	10	3	5011274072223
BU073	H7 (R477) Headlamp Bulbs plus wedge base bulbs for Japanese vehicles	1	10	3	5011274073336
BU078	H7 (R477) & H1 (R448) Headlamp Bulbs	2	10	3	5011274078881
BU079	H7 (R477) & HB3 (R9005) Headlamp Bulbs	2	10	3	5011274079994
BU080	H7 (R477) & H11 (R711) Headlamp Bulbs	2	6	2	5055175234861
BU087	H4 (R472) & H1 (R448) Headlamp Bulbs	2	10	3	5011274087777

Mini 12V Auto Bulb Kit

BU050	H4 (472) Headlamp Bulb	1	5	2	5055175219042
BU051	H1 (448) Headlamp Bulb	1	5	2	5055175219059
BU052	H7 (477) Headlamp Bulb	1	5	2	5055175219066
BU053	H7/H1 (477/448)	2	5	2	5055175219073
BU054	H4 (R472) & H1 (R448) & H7 (R477) Headlamp Bulbs	3	5	3	5055175219080

Universal Multi Headlamp 12V Auto Bulb Kit

BU027	H4 (R472) & H1 (R448) & H7 (R477) Headlamp Bulbs	3	12	4	5055175215631
-------	--	---	----	---	---------------

Vehicle Lighting

Value Packs 40



Value Packs

Great Value Promotional Line

- Includes free headlamp
- Ideal promotional tool to trade up
- Increases profitability



Part Number	Description	Pack Qty	Barcode
RVP477	H7 Value Pack	10 x 1	5055175226644

Contents

Part Number	Voltage	Wattage	ECE	Cap	Application	Qty
R477	12	55	H7	PX26d		2
R380	12	21/5	P21/5W	BAY15d		1
R382	12	21	P21W	BA15s		1
R245	12	10	R10W	BA15s		1
R501	12	5	W5W	W2.1x9.5d		1
10 amp blade fuse						1

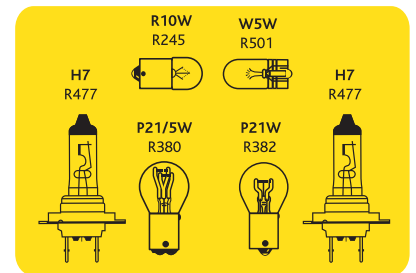

Part Number	Description	Pack Qty	Barcode
RVP472	H4 Value Pack	10x1	5055175226637

Contents

Part Number	Voltage	Wattage	ECE	Cap	Application	Qty
R472	12	60/55	H4	P43t		2
R380	12	21/5	P21/5W	BAY15d		1
R382	12	21	P21W	BA15s		1
R245	12	10	R10W	BA15s		1
R501	12	5	W5W	W2.1x9.5d		1
10 amp blade fuse						1

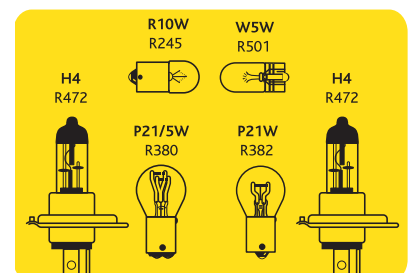

*Headlamps only



Biker Bulbs

For over 40 years Ring has been pushing the boundaries of motorcycle lighting. We were the first company to produce a halogen bulb that put up to 100% more light on the road XenonMax. Today it is Xenon150 that sets the standard. For a motorcyclist, being seen is equally important as seeing. We have designed a full range of lighting solutions to provide the safety your customer needs as well as the styling they are looking for.



Performance Halogens

Part Number	Voltage	Wattage	ECE	Cap	Application	Kelvin	Upgrades	Barcode
RMU412	12V	20W		P26S		3500K	R412	5055175213132
RMU417	12V	35/35W		BA20D		3500K	R417	5055175213149

Xenon150

Part Number	Voltage	Wattage	ECE	Cap	Application	Kelvin	Upgrades	Barcode
RMU1572	12V	60/55W	H4	P43t		3700K	R472	5055175243641
RMU1577	12V	55W	H7	PX26d		3700K	R477	5055175243658

XenonMax

Part Number	Voltage	Wattage	ECE	Cap	Application	Kelvin	Upgrades	Barcode
RU1048	12V	55W	H1	P14.5s		3500K	R448	5055175214924
RU1072	12V	60/55W	H4	P43t		3500K	R472	5055175214368
RU1077	12V	55W	H7	PX26d		3500K	R477	5055175214375





























UltraXenon

Part Number	Voltage	Wattage	ECE	Cap	Application	Kelvin	Upgrades	Barcode
RU948	12V	55W	H1	P14.5s		3500K	R448	5011274194819
RU972	12V	60/55W	H4	P43t		3500K	R472	5011274197216
RU977	12V	55W	H7	PX26d		3500K	R477	5011274197711
RU9905	12V	60W	HB3	P20d		3500K	R9005	5055175200606
RU9906	12V	51W	HB4	P22d		3500K	R9006	5055175200613

*Headlamps only

Vehicle Lighting

Boxed

Part Number	Voltage	Wattage	ECE	Cap	Application	Colour	Barcode	Ref	Barcode
RMU3625	6V	25/25W		PX15d			5055175211572	R3625	5055175213118
RMU392	6V	25/25W	S1	BA20D			5055175211596	R392	5011274053925
RMU393	6V	35/35W	S2	BA20D			5055175211602	R393	5011274039332
RMU3603	12V	25/25W		PX15d			5055175211565	R3603	5055175213101
RMU394	12V	25/25W	S1	BA20D			5055175211619	R394	5055175213125
RMU395	12V	35/35W	S2	BA20D			5055175211626	R395	5011274039592
RMU418	12V	23W		BA9s		Amber	5055175213583	R418	5055175212555
RMU448	12V	55W	H1	P14.5s			5055175211725	R448EQ	5011274041824
RMU459	12V	35/35W	HS1	PX43t			5055175211657	R459	5055175210902
RMU472	12V	60/55W	H4	P43t			5055175211732	R472	5011274047207
RMU477	12V	55W	H7	PX26d			5055175211749	R477	5011274047702
RMU610	12V	15W	S3	P26S			5055175211671	R610	5055175212425
RMU613	12V	20W		P26S			5055175211688	R613	5055175213156
RMU711	12V	55W	H11	PGJ19-2			5055175213590	R711	5011274071165
RMU7027	12V	35/35W		P15D-3			5055175211695	R7027	5055175213163
RMU7028	12V	45/40W		P15D-3			5055175211701	R7028	5055175213170
RMW207S	12V	5W	R5W	BA15s			5055175211794	207S	5011274021764
RMW233	12V	4W	T4W	BA9s			5055175211800	R233	5011274023362
RMW239	12V	5W	C5W	S8.5d			5055175211817	R239	5011274023966
RMW245S	12V	10W	R10W	BA15s			5055175211824	R245S	5011274024574
RMW380	12V	21/5W	P21/5W	BAY15d			5055175211831	R380	5011274038007
RMW382	12V	21W	P21W	BA15s			5055175211848	R382	5011274038205
RMW501	12V	5W	W5W	W2.1x9.5d			5055175211855	R501	5011274405160
RMW581	12V	21W	PY21W	BAU15s		Amber	5055175211862	R581	5011274058166
RMU293	6V	4W	T4W	BA9s			5055175211558	R293	5011274029363
RMU384	6V	21/5W	P21/5W	BAY15d			5055175211589	R384	5011274038465
RMU286	12V	1.2W		W2x4.6d			5055175211718	R286	5011274028671
RMU504	12V	3W	W5W	W2.1x9.5d			5055175211756	R504	5011274050467
RMU589	12V	10W	RY10W	BA15s		Amber	5055175211664	R589	5055175213200



12V and 24V Bulbs

With a range of over 650 references, Ring offers a one stop shop for autobulbs, from the fastest selling retail headlamp bulbs to specialist bulbs for the Engineering specifier in the commercial vehicle and construction equipment markets

Designed and manufactured to OE standards and E approved, where required, to ECE regulation 37 or 99, every bulb in the range is quality assured through our Quality Assurance department. You can rest assured that all the bulbs have been developed, tested and approved by our engineers.

Innovation is key to our bulb range, developing the latest technology performance bulbs for our customers. Ring are at the forefront of developing OE bulbs and making them available to the aftermarket as soon as a new vehicle application enters the market, ensuring that our customers can offer the same bulbs as the vehicle manufacturers.

Available in boxed packs for trade or in blister packs for self selection retail sale.



*Headlamps only

Vehicle Lighting



24V TruckMaster Bulbs

Fleet managers and drivers require a source of lighting they can depend on to deliver long life and durability.

Ring's OEM TruckMaster Heavy Duty Long Life (HDLL) 24v bulbs have been specifically designed to withstand excessive vibrations which vehicles are subjected to. Long life is achieved through a combination of filament technology and the gas mixture inserted within the glass envelope to a high pressure.

This improved performance provides substantial cost savings against vehicle downtime and maintenance costs. Overall running costs are improved by simply fitting Ring Automotive TruckMaster HDLL bulbs.

LIFE VS. COST

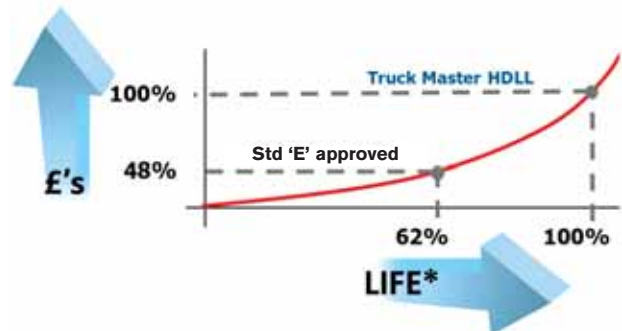

- Analysing the performance using life v's cost highlights the importance of specifying the correct bulb
- The correct bulb can save a vehicle downtime & costly servicing

* Based on static life test results
Graph to be used as a guide only
Bulb life may vary dependent on environmental factors

MAIN BENEFITS:

- Heavy Duty – Increased resistance to excessive vibration reducing maintenance downtime
- Long Life – Allows for higher mileage before regular replacement is required.
- Compliance with legal requirements – Reduced rates of bulb failure, improves driver's Operator Compliance Risk Score.

TECHNOLOGY:

- Reinforced filament providing extra strength and robustness against vibrations.
- Manufactured in Europe to OE (Original Equipment) specification and subjected to further vibration testing and conforms to IEC60810 European Vibration Standard.

OE Bulbs Heavy Duty Long Life - Boxed

The fleets choice where enduring performance is required for high mileage vehicles. Manufactured to OEM standards and E approved.

Suitable for commercial vehicles and construction equipment.

Available in heavy duty long life where extended life and vibration resistance is required to keep a vehicle on the road for even longer.



Part Number	Voltage	Wattage	ECE	Cap	Application	Colour	Pack Qty	Barcode
RTM149HDLL	24V	5W	R5W	BA15s			10 x 1	5055175221571
RTM150HDLL	24V	5W	R5W	BA15d			10 x 1	5055175221588
RTM241HDLL	24V	21W	P21W	BA15s			10 x 1	5055175221595
RTM246HDLL	24V	10W	R10W	BA15s			10 x 1	5055175221601
RTM249HDLL	24V	4W	T4W	BA9s			10 x 1	5055175221618
RTM346HDLL	24V	21W	P21W	BA15d			10 x 1	5055175221625
RTM588HDLL	24V	21W	PY21W	BAU15s		Amber	10 x 1	5055175221632
RTM460HDLL	24V	70W	H3	PK22s			10 x 1	5055175221649
RTM466HDLL	24V	70W	H1	P14.5s			10 x 1	5055175221656
RTM474HDLL	24V	70W	H7	PX26d			10 x 1	5055175221663
RTM475HDLL	24V	75/70W	H4	P43t			10 x 1	5055175221670

OE Bulbs Standard - Boxed

Part Number	Voltage	Wattage	ECE	Cap	Application	Colour	Pack Qty	Barcode
RTM149	24V	5W	R5W	BA15s			10 x 1	5011175209784
RTM150	24V	5W	R5W	BA15d			10 x 1	5055175209883
RTM241	24V	21W	P21W	BA15s			10 x 1	5055175209791
RTM242	24V	5W	C5W	S8.5d 11 x 38mm			10 x 1	5055175209890
RTM246	24V	10W	R10W	BA15s			10 x 1	5055175209906
RTM249	24V	4W	T4W	BA9s			10 x 1	5055175209913
RTM274	24V	10W		S8.5d 11 x 41mm			10 x 1	5055175209920
RTM283	24V	3W		BA7s			10 x 1	5055175209937
RTM289	24V	2W		BA9s			10 x 1	5055175209944
RTM294	24V	21/5W	P21/5W	BAY15d			10 x 1	5055175209951
RTM346	24V	21W	P21W	BA15d			10 x 1	5055175209968
RTM505	24V	3W	W3W	W2.1x9.5d			10 x 1	5055175209975
RTM507	24V	5W	W5W	W2.1x9.5d			10 x 1	5055175209982
RTM508	24V	1.2W		W2x4.6d			10 x 1	5055175209999
RTM508T	24V	1.2W		B8.5d		Grey base	10 x 1	5055175210001
RTM535	24V	21W	H21W	BA9s			10 x 1	5055175222325
RTM588	24V	21W	PY21W	BAU15s		Amber	10 x 1	5055175210018
RTM460	24V	70W	H3	PK22s			10 x 1	5055175210032
RTM466	24V	70W	H1	P14.5s			10 x 1	5055175210049
RTM474	24V	70W	H7	PX26d			10 x 1	5055175209814
RTM475	24V	75/70W	H4	P43t			10 x 1	5055175209821

*Headlamps only

Vehicle Lighting



Panel Bulb Kits

- Full colour selector guide
- All popular references
- Durable, resealable compartment box
- Product locator for easy and accurate replenishment
- Available in:
 - RPB121 12V Standard
 - RPB122 12V Special
 - RPB243 24V Standard



Contents

RPB121		12V Standard Panel Bulb Kit		RPB122		12V Special Panel Bulb Kit		RPB243		24V Standard Panel Bulb Kit	
Part Number	Qty	Part Number	Qty	Part Number	Qty	Part Number	Qty	Part Number	Qty	Part Number	Qty
R509TMOR	2	R509TMBK	3	R509TMGY	3	R509TVI	3	R508TMRE	2	R508TMGR	2
R509TMBE	2	R509TMGR	2	R509TBL	3	R509TBE	3	R508TBR	4	R508T	10
R509TMLBL	3	R509TOR	2	R86021001	3	R86021002	3	R508TBGY	4	R1471	10
R509T	10	R509TGR	3	R509TLBK	2	R509TKBK	2	R1791	10	R6929	2
R509TBBK	2	R509TBWH	2	R509TPBK	3	R509TWBR	3	R508TWBR	2	R508TCWH	2
R509TWGR	2	R509TWGY	2	R64124	2	R64122	2	R508CTCR	2	R508A	2
R509TDBK	2	R509TEBK	2	R509TCTR	3	R509TCGY	3	R508B	2	R508G	2
R509THGY	3	R286	10	R509TCGY/1.8	2	R509TCGYFR	2	R508R	2	R508TUWH	2
R286A	3	R286B	3	R509TCWH	3	R509TFBK/12	3	R508TVWH	2	R86021003	2
R286G	5	R286R	3	R509TFBK/14	2	R509TFGY	3	R86028166	2	R8328	2
R501A	5			R512TR	2	R512PC	1	R86024918	2		
				R509TQWH	2	R509TYBK	3				
				R512WB	2	R509TSBK	2				
				R88005996	2	R509TJBR	2				

Bulb Connectors

- Direct replacement
- Suitable for bulb upgrade higher wattage bulbs

Ceramic Bulb Holders



Part Number RBH001
Bulb Fitment H1/H3
 P14.5s/PK22s
Cable Rating 8.2A
Cable Length 130mm
 Straight cable exit

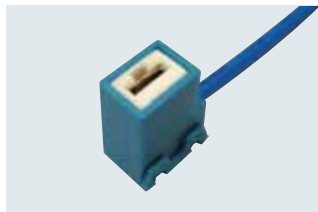

Part Number RBH002
Bulb Fitment H1/H3
 P14.5s/PK22s
Cable Rating 8.2A
Cable Length 130mm
 Angled cable exit

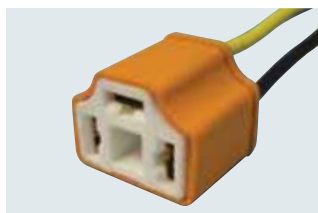

Part Number RBH003
Bulb Fitment H4
 P43t/P45t
Cable Rating 8.2A
Cable Length 130mm
 Straight cable exit

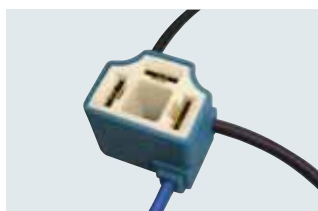

Part Number RBH004
Bulb Fitment H4
 P43t/P45t
Cable Rating 8.2A
Cable Length 130mm
 Angled cable exit



Part Number RBH005
Bulb Fitment H7
 PX26d
Cable Rating 8.2A
Cable Length 130mm
 Straight cable exit

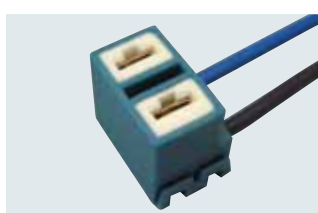

Part Number RBH006
Bulb Fitment H7
 PX26d
Cable Rating 8.2A
Cable Length 130mm
 Angled cable exit



Part Number RBH007
Bulb Fitment H11
 PGJ19-2
Cable Rating 8.2A
Cable Length 130mm
 Straight cable exit



Part Number RBH008
Bulb Fitment 9004 /9007
 P29t/Px29t
Cable Rating 8.2A
Cable Length 130mm
 Straight cable exit

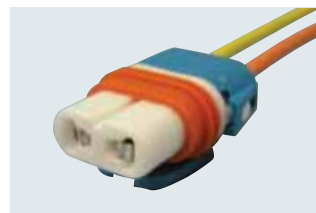

Part Number RBH009
Bulb Fitment 9005
 P20d
Cable Rating 8.2A
Cable Length 130mm
 Straight cable exit

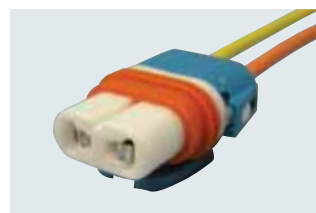

Part Number RBH010
Bulb Fitment 9006
 P22d
Cable Rating 8.2A
Cable Length 130mm
 Straight cable exit

Standard Bulb Holders



Part Number RBH011
Bulb Fitment BA15D
Cable Rating 8.2A
Cable Length 130mm
 Straight cable exit



Part Number RBH012
Bulb Fitment BA15S
Cable Rating 8.2A
Cable Length 130mm
 Straight cable exit

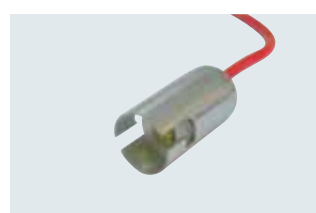

Part Number RBH013
Bulb Fitment BA9S
Cable Rating 8.2A
Cable Length 130mm
 Straight cable exit

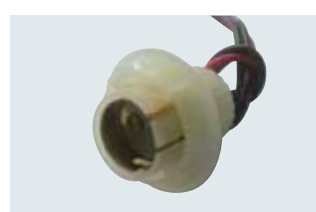

Part Number RBH014
Bulb Fitment BAY15D
Cable Rating 8.2A
Cable Length 130mm
 Straight cable exit

Vehicle Lighting

Single Boxed Stands

Ring provides your customers with a range of solutions to having Autobulbs at the point of installation. Carrying the fast moving references in a choice of either single or 10 way boxes, these wall mounted stands safely contain the stock in the workshop right next to the job in hand.



BU180

Stand Complete with Stock

Part Number	Qty	Part Number	Qty	Part Number	Qty
RB380	10	RB239	13	RB207S	13
RB269	13	RB382	10	RB233	13
RB209	13	RB286	13	RB581	10
RB501	13	RB245S	13	RB501A	13
R472	6	R453	10	R477	7
R448	10				
Total:	180				



BU280

Stand Complete with Stock

Part Number	Qty	Part Number	Qty	Part Number	Qty
RB149	13	RB505	13	RB150	13
RB507	13	RB241	10	RB508	13
RB242	13	RB508T	13	RB246	13
R460	10	RB249	13	R466	10
RB294	10	R474	7	RB346	10
R475	6				
Total:	180				



BU194

Stand Complete with Stock

Part Number	Qty	Part Number	Qty	Part Number	Qty
R472	6	RB585	4	RB233	5
R477	16	R434	4	RB245S	5
R448	11	RB335	4	RB504	5
RB380	11	RB343	4	RB501A	5
RB382	11	R435	4	RB501	14
RB581	11	RB272	5	RB239	14
RB566	4	RB955	5	RB207S	14
RB580	4	RB269	5	RB286	14
RB582	4	RB264	5		
Total:	194				

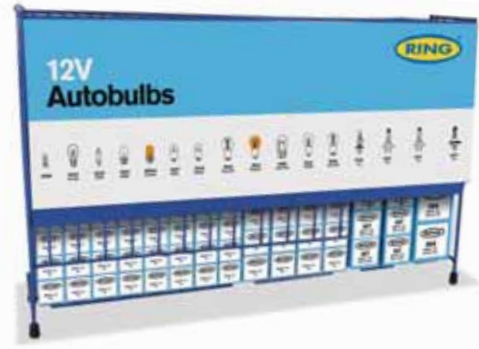

BU126

Stand Complete with Stock

Part Number	Qty	Part Number	Qty	Part Number	Qty
R448	5	R472	5	R477	6
RB380	10	RB382	10	RB581	10
RB245S	10	RB207S	10	RB209	10
RB501	10	RB501A	10	RB233	10
RB239	10	RB286	10		
Total:	126				

Refill stock packs available.

Marketing Support

For mechanics, knowledge equals confidence.

Therefore we set out to provide as much technical support as a mechanic will require. Our comprehensive bulb literature is constantly updated to ensure mechanics have access to the latest information. We provide work outs and training events to ensure mechanics maximise their sales of bulbs.



E Marking and Bulb Quality

Introduction

It's a fact the simple Autobulb is a safety critical component of any vehicle on the road today. Often overlooked, it's a key part of providing the right light ahead on a dark road or warning other road users a driver is braking or about to change direction. As it is vital to operate safely the bulbs must be manufactured to International Standards.

ECE Regulation 37

The Standard in ECE Regulation 37 most commonly adhered to the "37 mark" ECE Regulation 37 details exact specifications that cover the light output, filament geometry, voltage and wattage and the size and shape of the bulb.

How can I tell if a bulb meets ECE Regulation 37?

It should be marked with ALL the following information:

1. The trade name or mark of the manufacturer.
2. The rated voltage, typically 12V for passenger cars and 24V for commercial vehicles.
3. The international designation for the lamp e.g. W21W.
4. The rated wattage of the lamp including any dual filaments e.g. 21W or 21/15W. This is not required if the international designation identifies the wattage.
5. The approval mark in accordance with the specification for its size and shape (See Fig 1).

This consists of the following:

1. The designated E number (eg. 011) in a rectangular box followed by a unique 3 digit code. This can only be applied to lamp types for each manufacturer. This identifies the manufacturer.
2. In the case of a halogen bulb which has to meet the requirements of the UV light coating specification it may be marked with a U.

The above approval mark affixed to a filament lamp indicates the lamp has been approved in the United Kingdom (011) under the approval code A1. The final character of the approval code indicates the approval was granted in accordance with the requirements of ECE Regulation No. 37 as amended by the 02 and 03 series of amendments.

The Legal Requirements

In Ring's fit light assemblies (that carry their own performance approval numbered with bulbs that are not ECE approved) Road Vehicle Lighting Regulations). In addition, it is also legal to stock or offer these bulbs for sale in the UK (Filament Lamp for Vehicle (Safety) Regulation 1992). The standard for Gas Discharge light sources is ECE Reg. 98.



Vehicle Lighting

Bulb Guide

Diagram No. →

Category Description →

Typical Usage →

Halogen Headlamps



Bulb Image

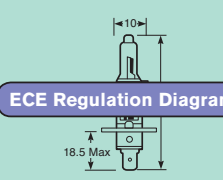

ECE Regulation Diagram

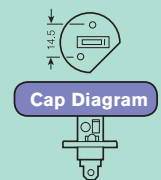

Cap Diagram

Cap Type →

ECE No. →

H1

P14.5s

Cross Reference Info

LAMP NO	VOLTS	WATTS	ECE NO	DESCRIPTION	PHILIPS	OSRAM	GE
© R448	12	55	H1		12258	64150	50310/1U

Key to Colours

Bulb type

- EQ bulb
- Long Life
- Extra Life
- XenonPlus (+30%)
- Xenon4000 (+30%)
- Xenon4400 (+30%)
- Xenon5000 (+50%)
- UltraXenon (+60%)
- XenonMax (+100%)
- Xenon130 (+130%)
- Xenon150 (+150%)
- HID 5500K (+20%)
- HID +100 (+100%)
- RallySport
- SportzBlue
- Ring LED
- Rapid Response
- Heavy Duty
- Truckmaster
- Truckmaster Heavy Duty Long Life

Bulb colour

- Amber
- Silver Amber
- Red
- Silver Red
- Blue
- Green
- Purple
- Multicolour

Halogen Headlamps



1

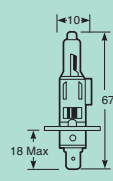





H1

P14.5s

LAMP NO	VOLTS	WATTS	ECE NO	DESCRIPTION	PHILIPS	OSRAM	GE
R465	6	55			6258	64168	
Ⓞ R448	12	55	H1		12258PR	64150	50310/1U
Ⓞ R448EQ	12	55	H1	EQ Bulb	12258PR	64150S	
Ⓞ R448LL	12	55	H1	Long life	12258LL/12258LLECO	64150ULT	50310DPU
Ⓞ R448HD	12	55	H1	Heavy Duty			
Ⓞ R848	12	55	H1	XenonPlus	12258PR		
Ⓞ R948	12	55	H1	UltraXenon	12258VP/12258NGDL	64150SV2	50310MPU
Ⓞ R1048	12	55	H1	XenonMax		64150NBS	50310XU
Ⓞ R1548	12	55	H1	Xenon150		64150NL	
Ⓞ R3348	12	55	H1	Xenon130	12258XV		50310XU
Ⓞ R4448	12	55	H1	Xenon4400	12258WHV	64150CBI	50310SBU
Ⓞ R5048	12	55	H1	Xenon5000			50310SUP
R481	12	100		RallySport	12454RA	62200SBP	52140U
R499	12	130		RallySport		64152SB	
R668	12	80		SportzBlue	12425RA		
Ⓞ R466	24	70	H1		13258	64155	50320/1U
Ⓞ R466HD	24	70	H1	Heavy Duty			
Ⓞ RTM466	24	70	H1	Truckmaster	13258	64155	50320/1U
Ⓞ RTM466HDLL	24	70	H1	Truckmaster Heavy Duty Long Life	13258ML	64155TSP	50320/1U_HDL
R493	24	100					

2

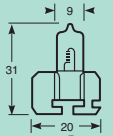

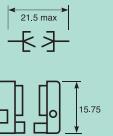

H2

X511

LAMP NO	VOLTS	WATTS	ECE NO	DESCRIPTION	PHILIPS	OSRAM	GE
R479	12	55			12311	64173	50410U
R480	12	100		RallySport	12507RA		52150U
R491	12	130		RallySport			
R482	24	70			13311	64175	50420U
R494	24	100					

Vehicle Lighting

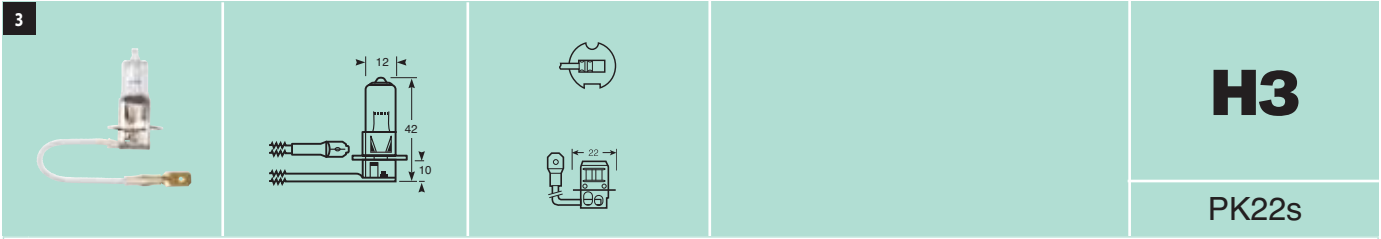

H3

PK22s

LAMP NO	VOLTS	WATTS	ECE NO	DESCRIPTION	PHILIPS	OSRAM	GE
R456	6	15					
R457	6	25					
Ⓢ R455	6	55	H3		6336	64147	
R445	12	10					
R446	12	20					
R462	12	35					
Ⓢ R453	12	55	H3	■ Long life	12336	64151	50340U
Ⓢ R453LL	12	55	H3	■ Long life	12336LL / 12336LLECO		50340DPU
Ⓢ R1053	12	55	H3	■ XenonMax	-	64151NBS	
R483	12	100		■ RallySport	12455RA	62201SBP	52130U
R492	12	130		■ RallySport			
R449	24	35					
R444	24	50					
R461	24	65					
Ⓢ R460	24	70	H3		13336	64156	50350U
Ⓢ R460HD	24	70	H3	■ Heavy Duty	13336MD	64156TSP	50350U_HDL
Ⓢ RTM460	24	70	H3	■ Truckmaster	13336MD	64156	50350U
Ⓢ RTM460HDLL	24	70	H3	■ Truckmaster Heavy Duty Long Life	13336ML	64156TSP	50350U_HDL
R495	24	100			13628RA		50400U
R441	36	45					
R442	48	45					
R443	80	55					

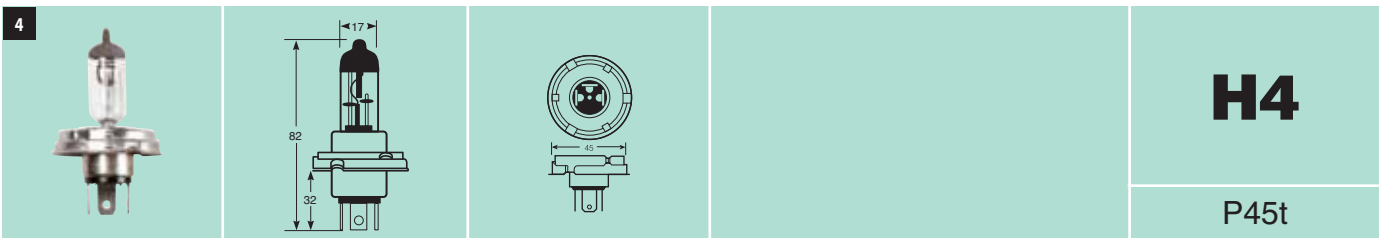

H4

P45t

LAMP NO	VOLTS	WATTS	ECE NO	DESCRIPTION	PHILIPS	OSRAM	GE
R012	12	60/55			12475	64198SB	52070U
R485	12	100/80		■ RallySport	12596RA	64194SB	52030U
R591	12	130/90		■ RallySport			
Ⓢ R904	12	45/40	R2		12475		52950
R024	24	75/70				64199	
R497	24	100/80					52730U

5					H4		
					P43t		
LAMP NO	VOLTS	WATTS	ECE NO	DESCRIPTION	PHILIPS	OSRAM	GE
R910	6	35/35	HS1				
Ⓢ R905	6	60/55	H4				
Ⓢ R459	12	35/35	HS1		12636	64185	50470U
R911	12	45/40					
R9003	12	60/55	HB2			9003L	
Ⓢ R472	12	60/55	H4		12342PR	64193	50440HU
Ⓢ R472EQ	12	60/55	H4	EQ Bulb	12342PR	94193	
Ⓢ R472LL	12	60/55	H4	Long life	12342LL/12342LLECO	64193ULT	50440DPU
Ⓢ R472EL	12	60/55	H4	Extra life			
Ⓢ R472HD	12	60/55	H4	Heavy Duty	12342HD		
Ⓢ R872	12	60/55	H4	XenonPlus	12342VP/13242NGDL		53800NHSU
Ⓢ R972	12	60/55	H4	UltraXenon	13342VP	64193SV2 / 64193NR5	50440MPU
Ⓢ R1072	12	60/55	H4	XenonMax	-	64193NBS / 64193NR1	50440SXU
Ⓢ R1572	12	60/55	H4	Xenon150	12342RV	64193NL	50440NXNU
Ⓢ R3372	12	60/55	H4	Xenon130	12342XV	64193NBL	50440XNU
R4072	12	60/55	H4	Xenon4000			
Ⓢ R4472	12	60/55	H4	Xenon4400	12342WHV	64193CBI	50440SBU
Ⓢ R5072	12	60/55	H4	Xenon5000		64193NL	50440SUP
R473	12	100/55		RallySport	12593RA		50440LU_DPU/52090U
R484	12	100/80		RallySport	12569RA	62204SBP	52100U
R490	12	130/90		RallySport		64194SB	52670
R590	12	160/90		RallySport			
R684	12	100/80		SportzBlue		64193NR	
Ⓢ R475	24	75/70	H4		13342	64196	50450U
Ⓢ R475HD	24	75/70	H4	Heavy Duty	13342MD	64196TSP	
Ⓢ RTM475	24	75/70	H4	Truckmaster	13342	64196TSP	50450
Ⓢ RTM475HDLL	24	75/70	H4	Truckmaster Heavy Duty Long Life	13342ML	64196TSP	50450HDLU
R496	24	100/80			24569RA	62248	52710U
R498	24	130/90				62249	52660

6					HB3		
					P20d		
LAMP NO	VOLTS	WATTS	ECE NO	DESCRIPTION	PHILIPS	OSRAM	GE
Ⓢ R3005	12	60	HB3	IceBlue	9005BV	9005CBI	53060U
Ⓢ R9005	12	60	HB3		9005PR	9005	53060U
Ⓢ R8005	12	60	HB3	XenonPlus	9005PR		
Ⓢ R9905	12	60	HB3	UltraXenon	-		
Ⓢ R1005	12	60	HB3	XenonMax		9005NBU	53060XU

Vehicle Lighting

7

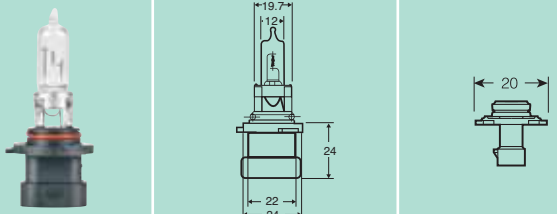

HB3A

P20d

LAMP NO	VOLTS	WATTS	ECE NO	DESCRIPTION	PHILIPS	OSRAM	GE
Ⓢ R9005XS	12	60	HB3A		-	9005XS	

8

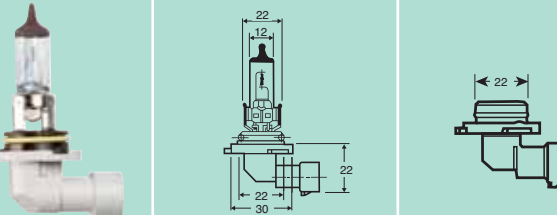

HB4

P22d

LAMP NO	VOLTS	WATTS	ECE NO	DESCRIPTION	PHILIPS	OSRAM	GE
Ⓢ R9006	12	51	HB4		9006PR	9006	53070U
Ⓢ R1006	12	51	HB4	■ XenonMax	-	9006NBU	53070SXU
Ⓢ R3306	12	51	HB4	■ Xenon 130			
Ⓢ R8006	12	51	HB4	■ XenonPlus	9006PR		
Ⓢ R9906	12	51	HB4	■ UltraXenon	-		

9

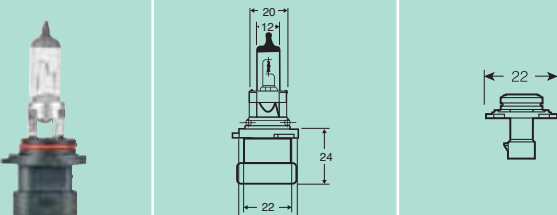

HB4A

P22d

LAMP NO	VOLTS	WATTS	ECE NO	DESCRIPTION	PHILIPS	OSRAM	GE
Ⓢ R9006XS	12	51	HB4A			9006XS	

10

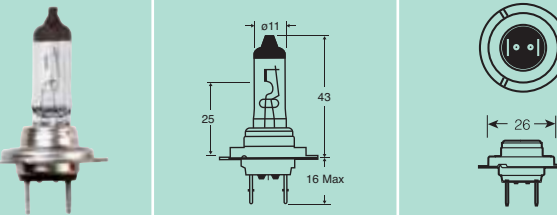

H7

PX26d

LAMP NO	VOLTS	WATTS	ECE NO	DESCRIPTION	PHILIPS	OSRAM	GE
Ⓢ R477	12	55	H7		12972PR	64210	58520U
Ⓢ R477LL	12	55	H7	■ Long life	12972LL / 12972LLECO	64210ULT	58520DPU
Ⓢ R477EL	12	55	H7	■ Extra life			
Ⓢ R477EQ	12	55	H7	■ EQ Bulb	12972PR		58520U
Ⓢ R477HD	12	55	H7	■ Heavy Duty	13972ML		
Ⓢ R877	12	55	H7	■ XenonPlus	12972PR		
Ⓢ R977	12	55	H7	■ UltraXenon	12972VP	64210SV2 / 64210NR5	58520MPU
Ⓢ R1077	12	55	H7	■ XenonMax	-	64210NBS / 64210NR1	58520SXU
Ⓢ R1577	12	55	H7	■ Xenon150	12972RV	64210NL	58520XNU
Ⓢ R3377	12	55	H7	■ Xenon130	12972XV	64210NBL	
Ⓢ R4077	12	55	H7	■ Xenon4000	12972WHV	64210CBI	
Ⓢ R4477	12	55	H7	■ Xenon4400	12972WHV	64210CBI	5820SBU
Ⓢ R5077	12	55	H7	■ Xenon5000			58520SUP
Ⓢ R464	12	100		■ RallySport	12035RA	62261SBP	
Ⓢ R664	12	80		■ SportzBlue		62210CBB	
Ⓢ R474	24	70	H7		13972	64215	58521U
Ⓢ R474HD	24	70	H7	■ Heavy Duty	13972MD	64215TSP	58521HDLU
Ⓢ RTM474	24	70	H7	■ Truckmaster	13972MD	64215TSP	58521U
Ⓢ RTM474HDLL	24	70	H7	■ Truckmaster Heavy Duty Long Life	13972ML	64215TSP	58521HDLU
Ⓢ R454	24	100					

11												H8
												PGJ19-1
LAMP NO	VOLTS	WATTS	ECE NO	DESCRIPTION	PHILIPS	OSRAM	GE					
© R708	12	35	H8		12360	64212	53090HU					

12												H8B
												PGJY19-1
LAMP NO	VOLTS	WATTS	ECE NO	DESCRIPTION	PHILIPS	OSRAM	GE					
© R920	12	35	H8B		-	64242						

13												H9
												PGJ19-5
LAMP NO	VOLTS	WATTS	ECE NO	DESCRIPTION	PHILIPS	OSRAM	GE					
© R709	12	65	H9		12361	64213	53100U					

14												H9B
												PGJY19-5
LAMP NO	VOLTS	WATTS	ECE NO	DESCRIPTION	PHILIPS	OSRAM	GE					
© R919	12	65	H9B		-	64243						

15												H10
												PY20d
LAMP NO	VOLTS	WATTS	ECE NO	DESCRIPTION	PHILIPS	OSRAM	GE					
© R710	12	42	H10		9145	9145	53080U					

Vehicle Lighting

16

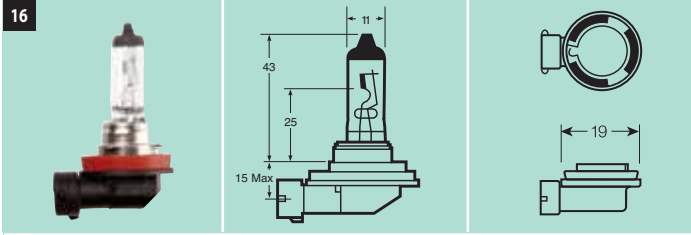

H11

PGJ19-2

LAMP NO	VOLTS	WATTS	ECE NO	DESCRIPTION	PHILIPS	OSRAM	GE
Ⓢ R711	12	55	H11		12362PR	64211	53110HU
Ⓢ R711LL	12	55	H11	■ Long life	12362LL/12362LLECO	64211ULT	58520LU_DPU
Ⓢ R1011	12	55	H11	■ XenonMax	-	64211NBS / 64211NR1	53110SXU
Ⓢ R1511	12	55	H11	■ Xenon150		64211NL	
Ⓢ R3311	12	55	H11	■ Xenon130			
Ⓢ R4011	12	55	H11	■ Xenon4000	12362WHV	64211CBI	53110XNU
Ⓢ R5011	12	55	H11	■ Xenon5000	-		53110SUP
Ⓢ R458	24	70	H11		24362MD		
Ⓢ R458HD	24	70	H11	■ Heavy Duty	24362MD	64216TSP	58521HDLU
Ⓢ RTM458HDLL	24	70	H11	■ Truckmaster Heavy Duty Long Life	24362ML	64216TSP	58521HDLU

17

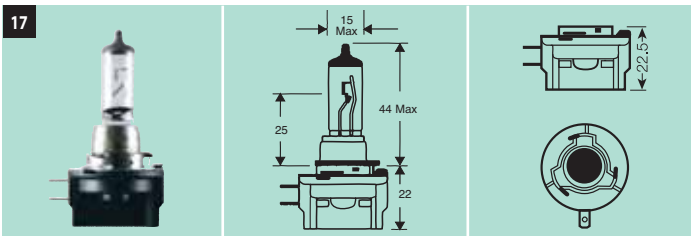

H11B

PGJY19-2

LAMP NO	VOLTS	WATTS	ECE NO	DESCRIPTION	PHILIPS	OSRAM	GE
Ⓢ R924	12	55	H11B		-	64241	

18

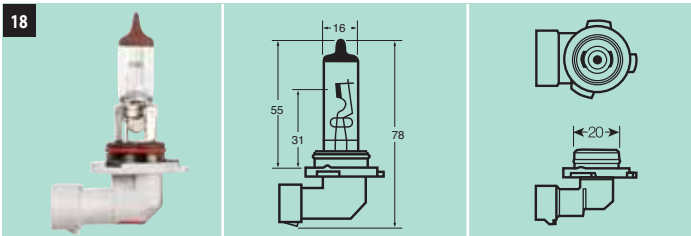

H12

PZ20d

LAMP NO	VOLTS	WATTS	ECE NO	DESCRIPTION	PHILIPS	OSRAM	GE
Ⓢ R712	12	53	H12				

19

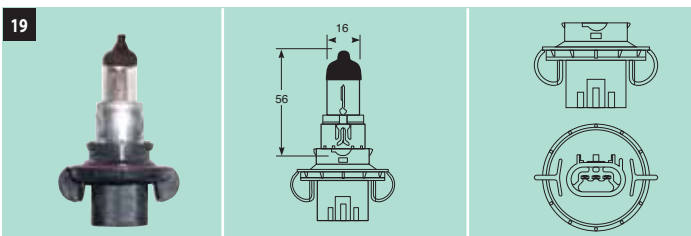

H13

P26.4t

LAMP NO	VOLTS	WATTS	ECE NO	DESCRIPTION	PHILIPS	OSRAM	GE
Ⓢ R9008	12	60/55	H13		9008	9008	

20

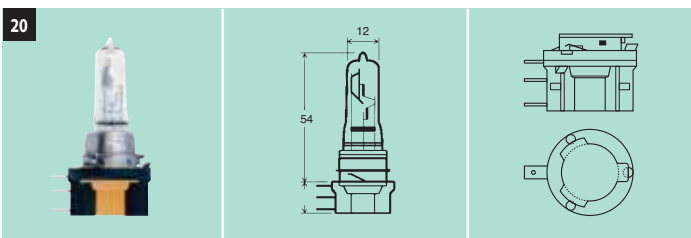

H15

PGJ23t-1

LAMP NO	VOLTS	WATTS	ECE NO	DESCRIPTION	PHILIPS	OSRAM	GE
Ⓢ R715	12	55/15	H15		12580	64176	

21											H16
											PGJ19-3
LAMP NO	VOLTS	WATTS	ECE NO	DESCRIPTION	PHILIPS	OSRAM	GE				
© R716	12	19	H16		12366	64219L					

22											H18
											PY26d
LAMP NO	VOLTS	WATTS	ECE NO	DESCRIPTION	PHILIPS	OSRAM	GE				
© R718	12	65	H18		12643	64180L					

23											H19
											PU43t-3
LAMP NO	VOLTS	WATTS	ECE NO	DESCRIPTION	PHILIPS	OSRAM	GE				
© R719	12	60/55	H19			64181L					

24											HIR1
											PX20d
LAMP NO	VOLTS	WATTS	ECE NO	DESCRIPTION	PHILIPS	OSRAM	GE				
© R9011	12	65	HIR1			9011					

25											HIR2
											PX22d
LAMP NO	VOLTS	WATTS	ECE NO	DESCRIPTION	PHILIPS	OSRAM	GE				
© R9012	12	55	HIR2		9012	9012	54430U				

Vehicle Lighting

Xenon HID

26



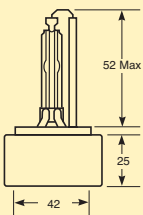

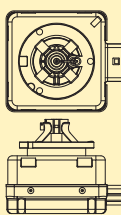

D1S

PK32d-2

LAMP NO	VOLTS	WATTS	ECE NO	DESCRIPTION	PHILIPS	OSRAM	GE
Ⓒ R85402	85	35	D1S		85415VI	66140	53620
Ⓒ R854025K	85	35	D1S	■ 5500K	85415WHV2	66140CBI	53750U
Ⓒ R85402100	85	35	D1S	■ +100	85415XV2	66140XNB	53620CMU

27



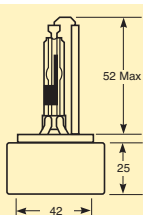

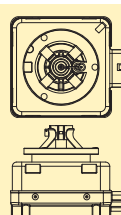

D1R

PK32d-3

LAMP NO	VOLTS	WATTS	ECE NO	DESCRIPTION	PHILIPS	OSRAM	GE
Ⓒ R85406	85	35	D1R		85409	66150	

28



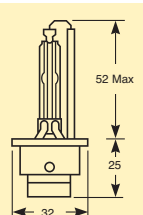

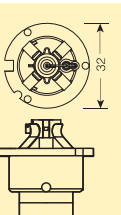

D2S

P32d-2

LAMP NO	VOLTS	WATTS	ECE NO	DESCRIPTION	PHILIPS	OSRAM	GE
Ⓒ R85122	85	35	D2S		85122VI	66240	53500
Ⓒ R851225K	85	35	D2S	■ 5500K	85122WHV2	66240CBI	53760U
Ⓒ R85122100	85	35	D2S	■ +100	85122XV2	66240XNB	53500CMU

29



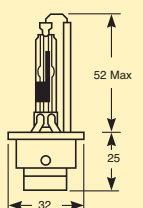

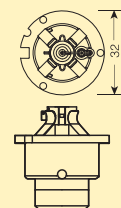

D2R

P32d-3

LAMP NO	VOLTS	WATTS	ECE NO	DESCRIPTION	PHILIPS	OSRAM	GE
Ⓒ R85126	85	35	D2R		85126VI	66250	53510
Ⓒ R851265K	85	35	D2R	■ 5500K	85126WHV2	66250CBI	53770

30



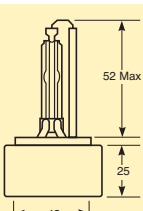

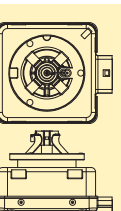

D3S

PK32d-5

LAMP NO	VOLTS	WATTS	ECE NO	DESCRIPTION	PHILIPS	OSRAM	GE
Ⓒ R42302	42	35	D3S		42403VI	66340	53660U
Ⓒ R423025K	42	35	D3S	■ 5500K	42403WHV2	66340CBI	53780U

31				D3R			
					PK32d-6		
LAMP NO	VOLTS	WATTS	ECE NO	DESCRIPTION	PHILIPS	OSRAM	GE
© R42306	42	35	D3R		42306V1	66350	

32				D4S			
					P32d-5		
LAMP NO	VOLTS	WATTS	ECE NO	DESCRIPTION	PHILIPS	OSRAM	GE
© R42402	42	35	D4S		42402VI	66440	53670U
© R424025K	42	35	D4S	■ 5500K	42402XV2	66440CBI	53790U

33				D4R			
					P32d-6		
LAMP NO	VOLTS	WATTS	ECE NO	DESCRIPTION	PHILIPS	OSRAM	GE
© R42406	42	35	D4R		42406	66450	

34				D5S			
					PK32d-7		
LAMP NO	VOLTS	WATTS	ECE NO	DESCRIPTION	PHILIPS	OSRAM	GE
© R12410	12-24	25	D5S		12410		

35				D8S			
					PK32d-1		
LAMP NO	VOLTS	WATTS	ECE NO	DESCRIPTION	PHILIPS	OSRAM	GE
© R66548	12	25	D8S			66548	

Vehicle Lighting



Motorcycle Headlamps

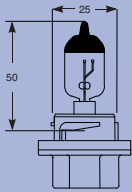

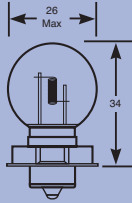
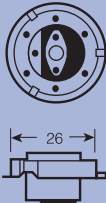

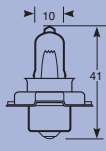
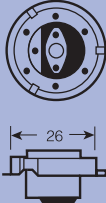
36  							HS5
							P23t
LAMP NO	VOLTS	WATTS	ECE NO	DESCRIPTION	PHILIPS	OSRAM	GE
Ⓒ R929	12	35/30	HS5				

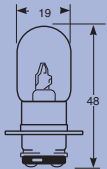
37   							S3
							P26s
LAMP NO	VOLTS	WATTS	ECE NO	DESCRIPTION	PHILIPS	OSRAM	GE
Ⓒ R609	6	15	S3				
Ⓒ R610	12	15	S3		12008		
R613	12	20					

38   							S3
							P26S
LAMP NO	VOLTS	WATTS	ECE NO	DESCRIPTION	PHILIPS	OSRAM	GE
R412	12	20					
Ⓒ R907	12	15	S3				

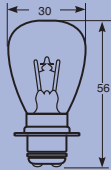
39   							PX15D
LAMP NO	VOLTS	WATTS	ECE NO	DESCRIPTION	PHILIPS	OSRAM	GE
R3625	6	25/25					
R3603	12	25/25					

40   							P15D-3
LAMP NO	VOLTS	WATTS	ECE NO	DESCRIPTION	PHILIPS	OSRAM	GE
R7027	12	35/35					
R7028	12	45/40					

41							P15D-25-3	
	LAMP NO	VOLTS	WATTS	ECE NO	DESCRIPTION	PHILIPS	OSRAM	GE
	R913	6	25/25					
	R914	6	35/35					

42							S2	
	LAMP NO	VOLTS	WATTS	ECE NO	DESCRIPTION	PHILIPS	OSRAM	GE
	R901	6	35/35					
	© R417	12	35/35	S2			64327	

Special Headlamps



43							H27W1	
	LAMP NO	VOLTS	WATTS	ECE NO	DESCRIPTION	PHILIPS	OSRAM	GE
	© R880	12	27	H27W/1		12059	880	54480U

44							H27W2	
	LAMP NO	VOLTS	WATTS	ECE NO	DESCRIPTION	PHILIPS	OSRAM	GE
	© R881	12	27	H27W/2		12060	881	54490U

45							H27W1	
	LAMP NO	VOLTS	WATTS	ECE NO	DESCRIPTION	PHILIPS	OSRAM	GE
	R885	12	50					
	R887	12	50		■ Long life			

Vehicle Lighting

46

PGJ13

LAMP NO	VOLTS	WATTS	ECE NO	DESCRIPTION	PHILIPS	OSRAM	GE
R894	12	37.5					
R886	12	50					

47

P36t

LAMP NO	VOLTS	WATTS	ECE NO	DESCRIPTION	PHILIPS	OSRAM	GE
R463	12	60/55					

Import Headlamps

48

P29t/PX29t

LAMP NO	VOLTS	WATTS	ECE NO	DESCRIPTION	PHILIPS	OSRAM	GE
R9004	12	65/45	(HB1)		9004	9004	9004
R9007	12	65/55	(HB5)		9007	9007	
R8004	12	65/45	(HB1)	■ XenonPlus			
R8007	12	65/55	(HB5)	■ XenonPlus			

49

P30/22L

LAMP NO	VOLTS	WATTS	ECE NO	DESCRIPTION	PHILIPS	OSRAM	GE
R964	12	45/55					
R963	12	65/55					
R965	12	65/65					

50

H3r

PK22sr

LAMP NO	VOLTS	WATTS	ECE NO	DESCRIPTION	PHILIPS	OSRAM	GE
R961	12	55					

51							MH6R
							P30t-40
LAMP NO	VOLTS	WATTS	ECE NO	DESCRIPTION	PHILIPS	OSRAM	GE
R962	12	55/40					

52						H3c	
						P22d/5	
LAMP NO	VOLTS	WATTS	ECE NO	DESCRIPTION	PHILIPS	OSRAM	GE
R447	12	55					
R960	12	55 (85)					

Asymmetric and Standard Headlamps

53							R2
							P45t ASY UEC
LAMP NO	VOLTS	WATTS	ECE NO	DESCRIPTION	PHILIPS	OSRAM	GE
Ⓢ R423	6	45/40	R2		6620	7950	1926
Ⓢ R410	12	45/40	R2		12620	64183	1931
R416	12	60/60					
Ⓢ R429	24	55/50	R2		13620	7952	1937

54							BA15d (SBC)
LAMP NO	VOLTS	WATTS	ECE NO	DESCRIPTION	PHILIPS	OSRAM	GE
R005	12	36			12221	7468	
R027	12	48				64199	
R123	24	36			13242		

Vehicle Lighting

55

BA15s (SCC)

LAMP NO	VOLTS	WATTS	ECE NO	DESCRIPTION	PHILIPS	OSRAM	GE
R002	12	36			12222		
R023	12	48					
R621	24	36					
R623	24	48			13241	7668	

56

**S1
S2
BA20d (Bosch)**

LAMP NO	VOLTS	WATTS	ECE NO	DESCRIPTION	PHILIPS	OSRAM	GE
Ⓒ R392	6	25/25	S1		6718	7323	91210
Ⓒ R393	6	35/35	S2		7008	7130	91220
Ⓒ R394	12	25/25	S1		12718	64326	
Ⓒ R395	12	35/35	S2		12728	7327	91221
R396	12	45/40			12748	7351	91231
R398	24	45/40					91232

British Pre-Focus Headlamps

57

P36s Axial

LAMP NO	VOLTS	WATTS	ECE NO	DESCRIPTION	PHILIPS	OSRAM	GE
R185	12	48				7447	

58

P36d Transverse

LAMP NO	VOLTS	WATTS	ECE NO	DESCRIPTION	PHILIPS	OSRAM	GE
R326	12	38					
R330	24	44					

59								
LAMP NO	VOLTS	WATTS	ECE NO	DESCRIPTION	PHILIPS	OSRAM	GE	
R323	12	48				7447		
R606	24	44						

60								
LAMP NO	VOLTS	WATTS	ECE NO	DESCRIPTION	PHILIPS	OSRAM	GE	
R312	6	30/24				6721		

61								
LAMP NO	VOLTS	WATTS	ECE NO	DESCRIPTION	PHILIPS	OSRAM	GE	
R331	24	44			13293			

62								
LAMP NO	VOLTS	WATTS	ECE NO	DESCRIPTION	PHILIPS	OSRAM	GE	
R414	12	50/40			12741			
R437	24	54/44			13741			

66		25		47		17 max		15		P21W	
										BA15d (SBC)	
LAMP NO	VOLTS	WATTS	ECE NO	DESCRIPTION	COLOUR	PHILIPS	OSRAM	GE			
Ⓞ R319	6	21	P21W			6402	6402				
Ⓞ R335	12	21	P21W			12442		1058			
R436	24	12									
Ⓞ R346	24	21	P21W			24004		1061			
Ⓞ R291	24	21	P21W	■ Heavy Duty				1061HD			
Ⓞ RTM346	24	21	P21W	■ Truckmaster		24004		1061			
Ⓞ RTM346HDLL	24	21	P21W	■ Truckmaster Heavy Duty Long Life		24004HDLL		1061HDL			
R333	24	24									
R344	28	26									

67		25		47		17 max		15		P21W	
										BA15d (SBC)	
LAMP NO	VOLTS	WATTS	ECE NO	DESCRIPTION	COLOUR	PHILIPS	OSRAM	GE			
R383	6	21/5	-			6503	7540				
R381	12	21/5	-			12503	7240	1098			
R692	24	24/6									

68		25		47		17 max		15		P21/5W	
										BAY15d (OSP)	
LAMP NO	VOLTS	WATTS	ECE NO	DESCRIPTION	COLOUR	PHILIPS	OSRAM	GE			
Ⓞ R384	6	21/5	P21/5W			6499	7517	1076			
Ⓞ R380	12	21/5	P21/5W			12499	7528	1077			
Ⓞ R380RR	12	21/5	P21/5W	■ RapidResponse		12499VP		1077NH			
Ⓞ R380LL	12	21/5	P21/5W	■ Long life		12499LL/12499LLECO	7528ULT	1077LFD			
Ⓞ R380HD	12	21/5	P21/5W	■ Heavy Duty							
R32/3	12	32/4CP									
R380R	12	21/5			●						
Ⓞ R294	24	21/5	P21/5W			13499	7537	1078			
Ⓞ RTM294	24	21/5	P21/5W	■ Truckmaster		13499	7537TSP	1078HDL			
R334	24	24/6									
R4597	48	25									
R4896	48	25/10									

Vehicle Lighting

69

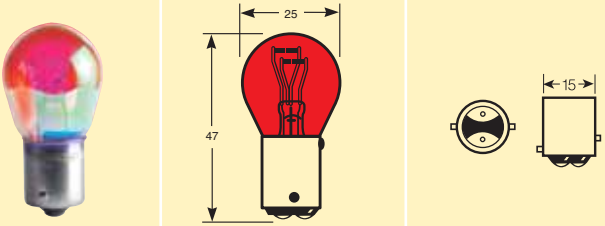

PR21/5W

BAW15d

LAMP NO	VOLTS	WATTS	ECE NO	DESCRIPTION	COLOUR	PHILIPS	OSRAM	GE
Ⓞ R780	12	21/5	PR21/5W		●	12495	7538LDR	
Ⓞ R3780	12	21/5	PR21/5W		●		7538LDR	

70

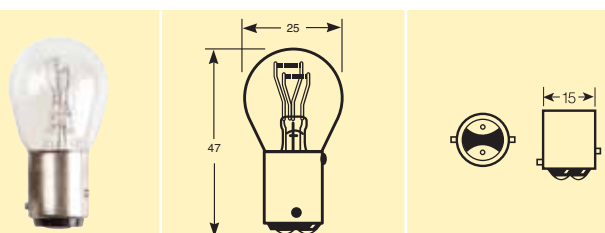

P21/4W

BAZ15d

LAMP NO	VOLTS	WATTS	ECE NO	DESCRIPTION	COLOUR	PHILIPS	OSRAM	GE
Ⓞ R566	12	21/4	P21/4W			12594	7225	1122
Ⓞ R567	24	21/4	P21/4W					

71

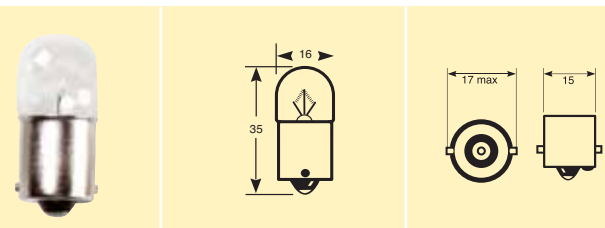

**R5W
R10W**

BA15s (SCC)

LAMP NO	VOLTS	WATTS	ECE NO	DESCRIPTION	COLOUR	PHILIPS	OSRAM	GE
Ⓞ R205	6	5	R5W			6821	5006	2615
Ⓞ R244	6	10	R10W			6814	5001	2639
Ⓞ R207	12	5	R5W			12821	5007	2619
Ⓞ R207RR	12	5	R5W	● RapidResponse			2619NH	2619NH
Ⓞ R207LL	12	5	R5W	■ Long life		12821LL/12821LLECO	5007ULT	2619LFD
Ⓞ R245	12	10	R10W			12814	5008	2641
Ⓞ R245RR	12	10	R10W	● RapidResponse				
Ⓞ R245LL	12	10	R10W	■ Long life		12814LLECO	5008ULT	2641LFD
Ⓞ R207B	12	5			●			
Ⓞ R245B	12	10			●			
Ⓞ R909	12	21						
Ⓞ R149	24	5	R5W			13821	5627	2627
Ⓞ R248	24	5	R5W	■ Heavy Duty		13821MD		2627HD
Ⓞ RTM149	24	5	R5W	■ Truckmaster		13821MD	5627TSP	2627
Ⓞ RTM149HDLL	24	5	R5W	■ Truckmaster Heavy Duty Long Life		13821ML	5627TSP	2627HDL
Ⓞ R246	24	10	R10W			13814MD	5637TSP	2643
Ⓞ R295	24	10	R10W	■ Heavy Duty		13814MD	5637	2643HD
Ⓞ RTM246	24	10	R10W	■ Truckmaster		13814	5637TSP	2643
Ⓞ RTM246HDLL	24	10	R10W	■ Truckmaster Heavy Duty Long Life		13814ML	5637TSP	2643HDL
Ⓞ R874	28	7						
Ⓞ R4187	48	10						

72

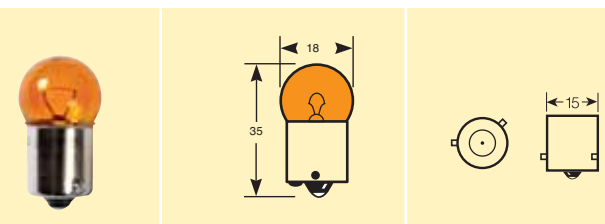

RY10W

BAU15s

LAMP NO	VOLTS	WATTS	ECE NO	DESCRIPTION	COLOUR	PHILIPS	OSRAM	GE
Ⓞ R589	12	10	RY10W		●	12093NA	5009	

73								R5W	
								BA15d (SBC)	
LAMP NO	VOLTS	WATTS	ECE NO	DESCRIPTION	COLOUR	PHILIPS	OSRAM	GE	
Ⓢ R206	6	5	R5W			6822	5406	2614	
Ⓢ R209	12	5	R5W			12822	5407	2618	
R210	12	10						2640	
Ⓢ R150	24	5	R5W			13822	5626	2626	
Ⓢ R247	24	5	R5W	■ Heavy Duty				2626HD	
Ⓢ RTM150	24	5	R5W	■ Truckmaster		13822	5627	2626	
Ⓢ RTM150HDLL	24	5	R5W	■ Truckmaster Heavy Duty Long Life		13822ML		2626HDL	
R875	28	7							

74								BAY15d (OSP)	
LAMP NO	VOLTS	WATTS	ECE NO	DESCRIPTION	COLOUR	PHILIPS	OSRAM	GE	
R4190	48	8							
R4192	48	10							

75								T4W	
								BA9s (MCC)	
LAMP NO	VOLTS	WATTS	ECE NO	DESCRIPTION	COLOUR	PHILIPS	OSRAM	GE	
Ⓢ R293	6	4	T4W			6929	3892	2659	
Ⓢ R233	12	4	T4W			12929	3893	2662	
Ⓢ R233LL	12	4	T4W	■ Long life		12929LL		2662LFD	
Ⓢ R833	12	4	T4W	■ IceBlue	●		3893CB		
R233B	12	4			●				
R143	24	2.8							
Ⓢ R249	24	4	T4W			13929	3930	2661	
R249G	24	4			●				
Ⓢ R296	24	4	T4W	■ Heavy Duty		13929MD		2661HD	
Ⓢ RTM249	24	4	T4W	■ Truckmaster		13929MD	3930TSP	2661	
Ⓢ RTM249HDLL	24	4	T4W	■ Truckmaster Heavy Duty Long Life		13929ML	3930TSP	2661HDL	
R1590	48	5							

76								BA9s (MCC)	
LAMP NO	VOLTS	WATTS	ECE NO	DESCRIPTION	COLOUR	PHILIPS	OSRAM	GE	
R951	6	5							
R989	12	5					3860		
R992	12	10							
R227	24	5							

Vehicle Lighting

77

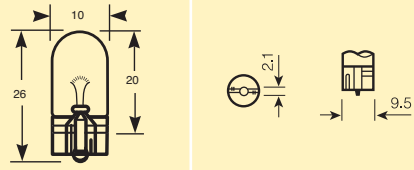
W3W
W5W
W2.1 x 9.5d

LAMP NO	VOLTS	WATTS	ECE NO	DESCRIPTION	COLOUR	PHILIPS	OSRAM	GE
R297	12	2.2				12960	2820	5313
Ⓢ R504	12	3	W3W			12256	2821	504
Ⓢ R501	12	5	W5W			12961	2825	501
R506	12	6				12040	2886X	
Ⓢ R501LL	12	5	W5W	■ Long life		12961ECO/12961LL	2825ULT	930FD
Ⓢ R501RR	12	5	W5W	■ RapidResponse				501NH
Ⓢ R501HD	12	5	W5W	■ Heavy Duty		12961		
R601	12	5		■ SportzBlue	●			
Ⓢ R801	12	5	W5W	■ IceBlue	●		2825CBI	91625 BLUE
R501B	12	5			●			
Ⓢ R1401	12	5	W5W	■ Xenon4400		12256BV	2825HCBI	
R298	24	2.2				13960	2840	
Ⓢ R505	24	3	W3W			13256	2841	5305
Ⓢ RTM505	24	3	W3W	■ Truckmaster		13256		91612
Ⓢ R507	24	5	W5W			13961	2845	91622
R507B	24	5			●			
Ⓢ RTM507	24	5	W5W	■ Truckmaster		13961	2845TSP	91622

78

WY5W
W2.1 x 9.5d

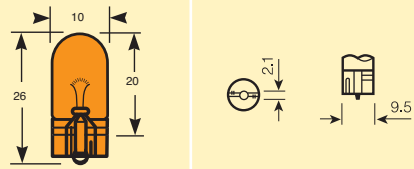
LAMP NO	VOLTS	WATTS	ECE NO	DESCRIPTION	COLOUR	PHILIPS	OSRAM	GE
Ⓢ R501A	12	5	WY5W		●	12396NA	2827	501A
R3501A	12	5			●			

79

WR5W
W2.1 x 9.5d

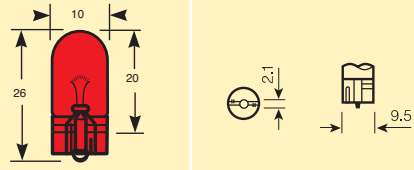
LAMP NO	VOLTS	WATTS	ECE NO	DESCRIPTION	COLOUR	PHILIPS	OSRAM	GE
Ⓢ R501R	12	5	WR5W		●			501NH

80

W10W
W2.1 x 9.5d

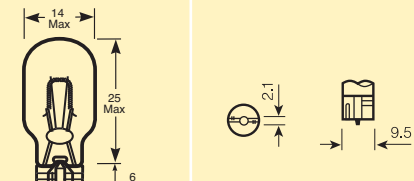
LAMP NO	VOLTS	WATTS	ECE NO	DESCRIPTION	COLOUR	PHILIPS	OSRAM	GE
R922	12	10						
Ⓢ R930	12	10	W10W					
R923	24	10						

81									WY10W
									W2.1 x 9.5d
LAMP NO	VOLTS	WATTS	ECE NO	DESCRIPTION	COLOUR	PHILIPS	OSRAM	GE	
© R931	12	10	WY10W		●				

82									W16W
									W2.1 x 9.5d
LAMP NO	VOLTS	WATTS	ECE NO	DESCRIPTION	COLOUR	PHILIPS	OSRAM	GE	
© R955	12	16	W16W			12067	921	W16W	
R921	12	21CP							

83									WY16W
									W2.1 x 9.5d
LAMP NO	VOLTS	WATTS	ECE NO	DESCRIPTION	COLOUR	PHILIPS	OSRAM	GE	
© R958	12	16	WY16W		●		921NA	NY16WNAL	
R921A	12	21CP			●				

84									W21W
									W3 x 16d
LAMP NO	VOLTS	WATTS	ECE NO	DESCRIPTION	COLOUR	PHILIPS	OSRAM	GE	
© R582	12	21	W21W			12065	7505	7440	

85									WY21W
									WX3 x 16d
LAMP NO	VOLTS	WATTS	ECE NO	DESCRIPTION	COLOUR	PHILIPS	OSRAM	GE	
© R585	12	21	WY21W		●	12071	7504	7440NA	

Vehicle Lighting

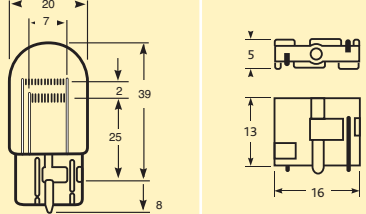
86									W21/5W
									W3 x 16q
LAMP NO	VOLTS	WATTS	ECE NO	DESCRIPTION	COLOUR	PHILIPS	OSRAM	GE	
Ⓒ R580	12	21/5	W21/5W			12066	7515	7443	

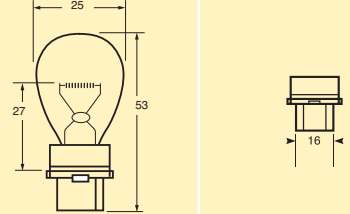
87									P27W
									W2.5 x 16d
LAMP NO	VOLTS	WATTS	ECE NO	DESCRIPTION	COLOUR	PHILIPS	OSRAM	GE	
Ⓒ R182	12	27	P27W				3156		
R184	12	27	-		●				

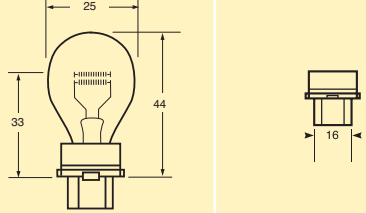
88									P27/7W
									W2.5 x 16q
LAMP NO	VOLTS	WATTS	ECE NO	DESCRIPTION	COLOUR	PHILIPS	OSRAM	GE	
Ⓒ R180	12	27/7	P27/7W				3157		

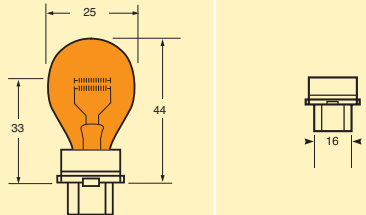

89									PY27/7W
									WX2.5 x 16q
LAMP NO	VOLTS	WATTS	ECE NO	DESCRIPTION	COLOUR	PHILIPS	OSRAM	GE	
Ⓒ R183	12	27/7	PY27/7W		●		3757AK		

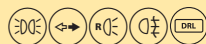
Hiper Vision

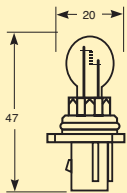

90									P13W
									PCY16W
LAMP NO	VOLTS	WATTS	ECE NO	DESCRIPTION	COLOUR	PHILIPS	OSRAM	GE	
Ⓒ R12277	12	13	P13W			12277			
Ⓒ R925	12	16	PCY16W		●				

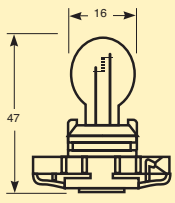
91







**PS19W
PSY19W**

PG20-1 / PG20-2

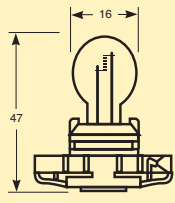
LAMP NO	VOLTS	WATTS	ECE NO	DESCRIPTION	COLOUR	PHILIPS	OSRAM	GE
© R12085	12	19	PS19W			12085	5201	
© R12275	12	19	PSY19W		●	12275		

92





**PS24W
PSY24W
PY24W
PSX24W**

PG20-3 / PGU20-4 / PG20-7

LAMP NO	VOLTS	WATTS	ECE NO	DESCRIPTION	COLOUR	PHILIPS	OSRAM	GE
© R12086	12	24	PS24W			12086	5202	
© R12188	12	24	PSY24W		●	12188NA		
© R12190	12	24	PY24W		●	12190NA		
© R12274	12	24	PY24W		●	12274SV+		
© R12276	12	24	PSX24W			12276	2504	

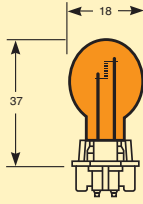
93





**PW24W
PWY24W**

WP3.3x14.5-4

LAMP NO	VOLTS	WATTS	ECE NO	DESCRIPTION	COLOUR	PHILIPS	OSRAM	GE
© R12182	12	24	PW24W		●	12182HTR		
© R12174HTR	12	24	PWY24W		●	12174HTR		

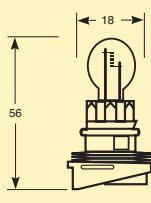
94





P24W

PU20-3

LAMP NO	VOLTS	WATTS	ECE NO	DESCRIPTION	COLOUR	PHILIPS	OSRAM	GE
© R928	12	24	P24W			13625		

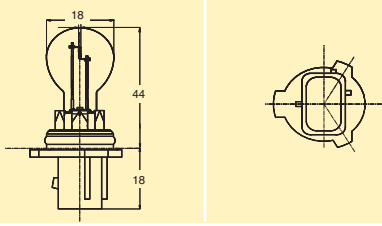
95





PSX26W

PG18.5d-3

LAMP NO	VOLTS	WATTS	ECE NO	DESCRIPTION	COLOUR	PHILIPS	OSRAM	GE
© R12278	12	26	PSX26W			12278		

Vehicle Lighting

Festoon 

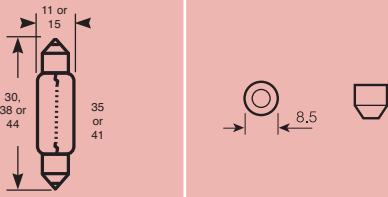
96  

C5W

S8.5d

LAMP NO	VOLTS	WATTS	SIZE	ECE NO	DESCRIPTION	COLOUR	PHILIPS	OSRAM	GE
Ⓢ R253	6	5	11x38	C5W			6844	6416	7544
Ⓢ R239	12	5	11x38	C5W			12844	6418	7546
Ⓢ R239LL	12	5	11x38	C5W	■ Long life			6418ULT	7546LFD
R258	12	5	11x42				12864	6413	7575
R254	12	6	11x38					6486X	
R237	12	7	10x40				12144		
R264	12	10	11x44				12866	6411	7576
R269	12	10	11x30				12860	6438	7585
R272	12	10	11x38				12854	6461	91715
Ⓢ R242	24	5	11x38	C5W		●	13844	6423	7552
R242G	24	5	11x38						
Ⓢ RTM242	24	5	11x38	C5W	■ Truckmaster			6423	7552
R260	24	5	11x42				13864	6424	7579
R653	24	6	11x38				13844		
R274	24	10	11x41				13866	6429	7580
RTM274	24	10	11x41		■ Truckmaster		13866	6429	7580

97  

C21W

S8.5d

LAMP NO	VOLTS	WATTS	SIZE	ECE NO	DESCRIPTION	COLOUR	PHILIPS	OSRAM	GE
R266	6	15	15x44						
R265	12	10	15x44						
R267	12	15	15x44				12850	6541	7592
R270	12	18	15x44				12807	6475	7593
Ⓢ R273	12	21	15x44	C21W			12803	6476	91761
R276	24	18	15x44				13807	8480	7595
R275	24	21	15x44						

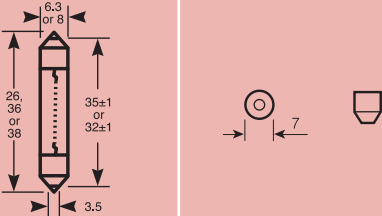
98  

S6d / S7d

LAMP NO	VOLTS	WATTS	SIZE	ECE NO	DESCRIPTION	COLOUR	PHILIPS	OSRAM	GE
R256	12	3	8x38				12843		
R263	12	3	8x31					2628	91701
R268	12	3	6x36				12848	6428	
R261	12	5	8x26						
R271	24	3	7x30				13818	6430	91702
R908	24	3	8x36					6421	

Miniature Halogen



99								BA9s (MCC)	
LAMP NO	VOLTS	WATTS	ECE NO	DESCRIPTION	COLOUR	PHILIPS	OSRAM	GE	
R469	12	5				12023	64111	58540	
R470	12	10				12024	64113	58560	
R433	12	20				12025	64115	56110	
R418	12	23			●				
R419	12	23							

100								H6W	
LAMP NO	VOLTS	WATTS	ECE NO	DESCRIPTION	COLOUR	PHILIPS	OSRAM	GE	
© R434	12	6	H6W			12036	64132	52830U	
© R834	12	6	H6W	IceBlue	●	12036BV			

101								HY6W	
LAMP NO	VOLTS	WATTS	ECE NO	DESCRIPTION	COLOUR	PHILIPS	OSRAM	GE	
© R926	12	6	HY6W		●				

Vehicle Lighting

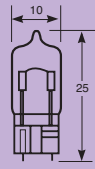
102





(W5W)

W2.1 x 9.1d

LAMP NO	VOLTS	WATTS	ECE NO	DESCRIPTION	COLOUR	PHILIPS	OSRAM	GE
R514	12	5						
R516	12	5		IceBlue	●		2825HCBI	

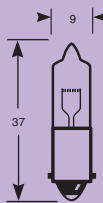
103





H21W

BAY9s

LAMP NO	VOLTS	WATTS	ECE NO	DESCRIPTION	COLOUR	PHILIPS	OSRAM	GE
Ⓒ R435	12	21	H21W			12356	64136	
Ⓒ R535	24	21	H21W			24356	64138	
Ⓒ RTM535	24	21	H21W	Truckmaster	■	24356	64138	

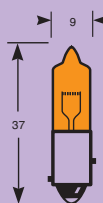
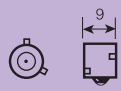
104





HY21W

BAW9s

LAMP NO	VOLTS	WATTS	ECE NO	DESCRIPTION	COLOUR	PHILIPS	OSRAM	GE
Ⓒ R927	12	21	HY21W		●	12146	64137ULT	

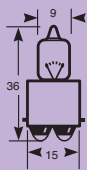
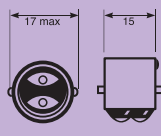
105

BA15d (SBC)

LAMP NO	VOLTS	WATTS	ECE NO	DESCRIPTION	COLOUR	PHILIPS	OSRAM	GE
R471	12	10						

106									BA15s (SCC)
LAMP NO	VOLTS	WATTS	ECE NO	DESCRIPTION	COLOUR	PHILIPS	OSRAM	GE	
R467	12	5						58570	
R468	12	10						58580	
R740	12	20							
R906	12	21							
R796	12	35							
R795	12	50							
R741	24	20							

107									G4
LAMP NO	VOLTS	WATTS	ECE NO	DESCRIPTION	COLOUR	PHILIPS	OSRAM	GE	
R569	12	5							
R570	12	10							
R573	12	20							
R574	24	10							
R571	24	20							

Panel and Indicator

108									W2.3W WY2.3W
LAMP NO	VOLTS	WATTS	ECE NO	DESCRIPTION	COLOUR	PHILIPS	OSRAM	GE	
R286	12	1.2					12516	2721	5301
R286A	12	1.2			●				
R286B	12	1.2			●				
R286G	12	1.2			●				
R286R	12	1.2			●				
Ⓢ R284	12	2.3		W2.3W		12061	2723	91605	
Ⓢ R284A	12	2.3		WY2.3W	●				
R1030	14	0.9(65mA)							
R508	24	1.2				13516	2741	91602	
R508A	24	1.2			●				
R508B	24	1.2			●				
R508G	24	1.2			●				
R508R	24	1.2			●				
RTM508	24	1.2		Truckmaster		13516		91602	

109									E10/13/14 MES
LAMP NO	VOLTS	WATTS	ECE NO	DESCRIPTION	COLOUR	PHILIPS	OSRAM	GE	
R950	6	6							
R862	12	5						2683	
R993	24	2.8				13875			

Vehicle Lighting

110

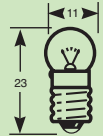
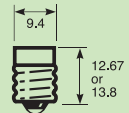



G11

E10/13 MES

LAMP NO	VOLTS	WATTS	ECE NO	DESCRIPTION	COLOUR	PHILIPS	OSRAM	GE
R982	6	1.8						
R981	6	3						
R990	6	3				6875	3965	
R987	12	2.2				12875	3766	2683
R650	24	2.8				13875	3967	

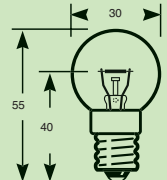
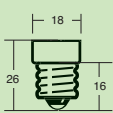
111

E14

LAMP NO	VOLTS	WATTS	ECE NO	DESCRIPTION	COLOUR	PHILIPS	OSRAM	GE
R917	12	15						
R916	12	25						

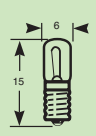
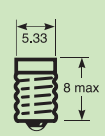

112

E5/8 LES

LAMP NO	VOLTS	WATTS	ECE NO	DESCRIPTION	COLOUR	PHILIPS	OSRAM	GE
R280	12	1.5				12926		
R864/14	14	0.5						
R285	24	1						
R687	24	1.2						
R695	24	2.8						

113

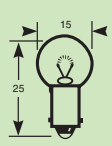
BA9s MCC

LAMP NO	VOLTS	WATTS	ECE NO	DESCRIPTION	COLOUR	PHILIPS	OSRAM	GE
R651	24	2.8						

114

Midget Groove

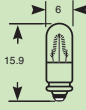
LAMP NO	VOLTS	WATTS	ECE NO	DESCRIPTION	COLOUR	PHILIPS	OSRAM	GE
R388	28	1.2 (40mA)						

115

BA9s MCC

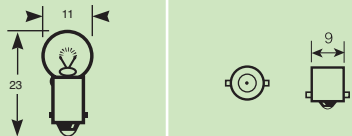
LAMP NO	VOLTS	WATTS	ECE NO	DESCRIPTION	COLOUR	PHILIPS	OSRAM	GE
R641	6	3				6910	6910	
R643	12	2.2				12910	3894	
R865	24	2.8				13910	6251	
RTM865	24	2.8		■ Truckmaster				

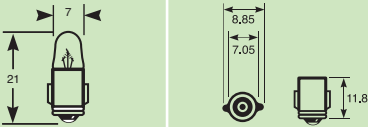

116

BA7s Peanut

LAMP NO	VOLTS	WATTS	ECE NO	DESCRIPTION	COLOUR	PHILIPS	OSRAM	GE
R282	6	1.2				6829	3798	2960
R281	12	2				12829	3898	2696
R283	24	3				13829	3899	2692
RTM283	24	3		■ Truckmaster				

117

BA9s MCC (Tub.)

LAMP NO	VOLTS	WATTS	ECE NO	DESCRIPTION	COLOUR	PHILIPS	OSRAM	GE
R287	6	2					3895	
R288	12	2				12913	3796	2660
R289	24	2				13913	3797	2663
RTM289	24	2		■ Truckmaster		13913	3797	2663

Vehicle Lighting

Printed Circuit Board Lamps



118

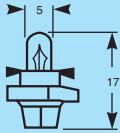

B8.4D / BX8.4D

LAMP NO	VOLTS	WATTS	BASE COLOUR	PANEL THICKNESS	PHILIPS	OSRAM	GE
R509TMGY	12	0.5	Grey BX8.4D	1.5mm			
R509TMOR	12	1.12	Orange BX8.4D	1.5mm	12624	2473MFX6	
R509TMBK	12	1.2	Black BX8.4D	1.5mm	12625	2351MFX6	91641PS
R509TMBL	12	1.2	Blue B8.4D	2.0mm	12623	2351MF6	
R509TMBE	12	1.5	Beige BX8.4D	1.5mm	12627	2452MFX6	91646PS
R509TMGR	12	2	Light Green 8.4D	2.0mm	12626	2352MFX6	91645PS
R508TMGR	24	1.4	Light Green 8.4D				
R508TMRE	24	1.5	Red BX8.4D				

119

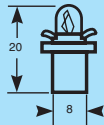

B8.5D / BX8.5D

LAMP NO	VOLTS	WATTS	BASE COLOUR	PANEL THICKNESS	PHILIPS	OSRAM	GE
R509TVI	12	0.4	Violet BX8.5D	1.5mm	12640	2322MFX	
R509TOR	12	1	Orange BX8.5D	1.5mm		2321MFX	
R509T	12	1.2	Black B8.5D	2.0mm	12598	2721MF	5301PS
R509TBL	12	1.2	Light Blue BX8.5D	1.5mm	12603	2721MFX	
R509TBE	12	1.5	Beige B8.5D	2.0mm	12637	2752MF	
R509TGR	12	2	Green B8.5D	2.0mm	12600	2722MF	5303PS
R508T	24	1.2	Grey B8.5D		13598	2741MF	5302PS
R508TBR	24	1.2	Brown BX8.5D		24032	2741MFX	
RTM508T	24	1.2	Grey B8.5D	■ Truckmaster	13598	2741MF	5302PS

120



B8.7D

LAMP NO	VOLTS	WATTS	BASE COLOUR	PANEL THICKNESS	PHILIPS	OSRAM	GE
R509TWBR	12	1.2	Brown				91651PS
R509TWGY	12	1.2	Grey			2721MF8W	
R509TWGR	12	2	Green		12604	2721MF8W	
R508TWBR	24	1.2	Brown				

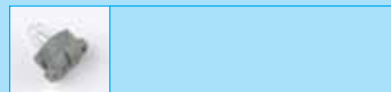
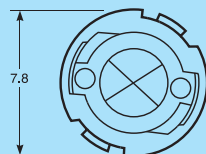
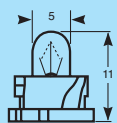

121



F4.8

LAMP NO	VOLTS	WATTS	BASE COLOUR	PANEL THICKNESS	PHILIPS	OSRAM	GE
R509TFBK/12	12	1.2	Black				
R509TFGY	12	1.8	Grey				
R509TFBK/14	14	1.4	Black			2722MF	91695PS14V

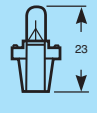
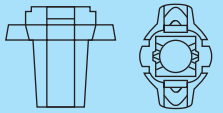

122

B8.3D

LAMP NO	VOLTS	WATTS	BASE COLOUR	PANEL THICKNESS	PHILIPS	OSRAM	GE
R509TBBK	12	1.2	Black		12597	2721MF8	91671PS
R509TBWH	12	2	White			2722MF8	91665PS
R508TBY	24	1.2	Grey		13597	2741MF8	

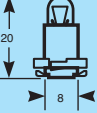
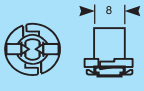

123

BAX EBSR

LAMP NO	VOLTS	WATTS	BASE COLOUR	PANEL THICKNESS	PHILIPS	OSRAM	GE
R86021001	12	1.2	Green	2.0mm			
R86021002	12	1.8	Blue	2.0mm			91696PS
R6929	24	1.2	Light Green				
R1471	24	1.2 (40mA)	Brown		24506		91693
R1791	24	1.2 (53mA)	Yellow		24029		91693

124

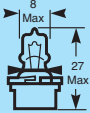



Panel thickness
B = 2mm
BX = 1.5mm

B10d

LAMP NO	VOLTS	WATTS	BASE COLOUR	PANEL THICKNESS	PHILIPS	OSRAM	GE
R64122	12	3	Brown		12614	64122MF	
R64124	12	5	Black		12615	64122MF	

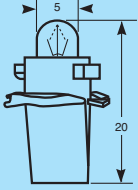
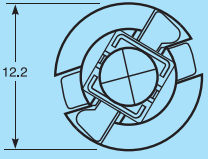
125







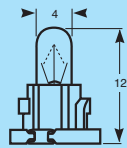
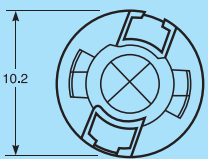

BX2D

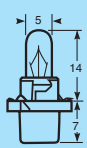
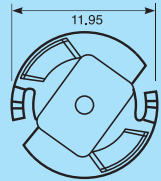
LAMP NO	VOLTS	WATTS	BASE COLOUR	PANEL THICKNESS	PHILIPS	OSRAM	GE
R509TEBK	12	1.2	Black	1.5mm			

Vehicle Lighting

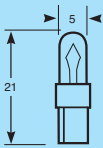

126								T-1/4NW
LAMP NO	VOLTS	WATTS	BASE COLOUR	PANEL THICKNESS	PHILIPS	OSRAM	GE	
R509TDBK	12	1.2	Black					

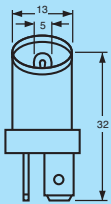

127								T-1.1/2TW
LAMP NO	VOLTS	WATTS	BASE COLOUR	PANEL THICKNESS	PHILIPS	OSRAM	GE	
R509THGY	14	1.2 (90mA)	Grey					

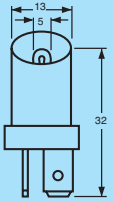
128								KW2 x 4.6D
LAMP NO	VOLTS	WATTS	BASE COLOUR	PANEL THICKNESS	PHILIPS	OSRAM	GE	
R509TCGY	12	0.5	Grey				91609PS	
R509TCGYFR	12	0.5	Grey Frosted				91609PS/91608PS	
R509TCTR	12	1.2	Transparent					
R509TCWH	12	1.2	White					
R509TCGY/1.8	12	1.8	Grey					
R508TCTR	24	1.2	Transparent					
R508TCWH	24	1.2	White					
R508TD	24	1	White					

129								B9
LAMP NO	VOLTS	WATTS	BASE COLOUR	PANEL THICKNESS	PHILIPS	OSRAM	GE	
R513BWH	24	1.5	White					

130								B9
								GE
LAMP NO	VOLTS	WATTS	BASE COLOUR	PANEL THICKNESS	PHILIPS	OSRAM	GE	
R508TUWH	24	2.4	White					

131								B29
								GE
LAMP NO	VOLTS	WATTS	BASE COLOUR	PANEL THICKNESS	PHILIPS	OSRAM	GE	
R508TVWH	24	1.4	White					

132								T3
								GE
LAMP NO	VOLTS	WATTS	BASE COLOUR	PANEL THICKNESS	PHILIPS	OSRAM	GE	
R509TJBR	14	1.2 (60mA)	Brown					

133								B8.5 5/40
								GE
LAMP NO	VOLTS	WATTS	BASE COLOUR	PANEL THICKNESS	PHILIPS	OSRAM	GE	
R509TKBK	12	1.2	Black					

Vehicle Lighting

								BG8.5 - 5.5D
								LAMP NO R509TLBK

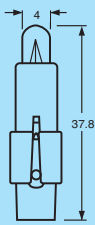
								SG8-5.5D
								LAMP NO R509TPBK

								T3
								LAMP NO R509TQWH

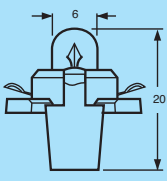
								B11D
								LAMP NO R509TSBK

138								T5
								GE
LAMP NO	VOLTS	WATTS	BASE COLOUR	PANEL THICKNESS	PHILIPS	OSRAM	GE	
R509TYBK	14	1.4	Black					

139								KW2.1 x 9.5D
								GE
LAMP NO	VOLTS	WATTS	BASE COLOUR	PANEL THICKNESS	PHILIPS	OSRAM	GE	
R512WB	12	2	White					

140								EBS-N10
								GE
LAMP NO	VOLTS	WATTS	BASE COLOUR	PANEL THICKNESS	PHILIPS	OSRAM	GE	
R86021003	24	1.2	Yellow	EBS-N	24606			
R86024918	24	1.2	Grey	BAX10D				
R8328	24	1.4	Beige					
R86028166	24	2.4	Yellow					

141								EBS-P/PM
								GE
LAMP NO	VOLTS	WATTS	BASE COLOUR	PANEL THICKNESS	PHILIPS	OSRAM	GE	
R88005996	12.6	1.5	White					

Vehicle Lighting

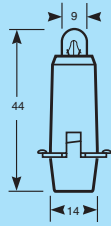
142									PCB
									GE
LAMP NO	VOLTS	WATTS	BASE COLOUR	PANEL THICKNESS	PHILIPS	OSRAM	GE		
R512PCB	12	2CP	White						



143									B12.3D
									GE
LAMP NO	VOLTS	WATTS	BASE COLOUR	PANEL THICKNESS	PHILIPS	OSRAM	GE		
R512TR	12	2CP	White						

LED Bulbs

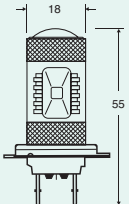

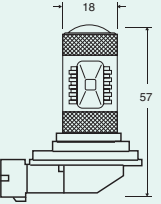
144									(H7)
									PX26d
LAMP NO	VOLTS	DESCRIPTION	COLOUR TEMP	LUMENS	PHILIPS	OSRAM	GE		
R477FLED	12	Premium Fog Light LED	6000K	600					

145									(H11)
									PGJ19-2
LAMP NO	VOLTS	DESCRIPTION	COLOUR TEMP	LUMENS	PHILIPS	OSRAM	GE		
R711FLED	12	Premium Fog Light LED	6000K	600					

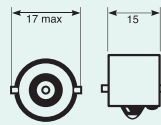
146	  								(P21W)
									BA15s (SCC)
LAMP NO	VOLTS	DESCRIPTION	COLOUR TEMP	LUMENS	PHILIPS	OSRAM	GE		
① R382DLED	12	Performance LED	7000K	560					
② R382LED	12	Premium LED	6000K	530					
③ R3823FSL LED	12	Filament Style LED	3000K	390					
④ R2416LED	24	Premium LED	6000K	530					
⑤ R2413FSL LED	24	Filament Style LED	3000K	395					

147

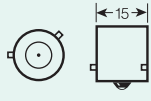



(PY21W)

BAU15s (OSP)

LAMP NO	VOLTS	DESCRIPTION	COLOUR TEMP	LUMENS	COLOUR	PHILIPS	OSRAM	GE
R581AFSLED	12	Filament Style LED	2000K	280	●			

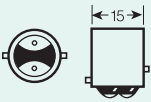
148





(P21/5W)

BAY15d (OSP)

LAMP NO	VOLTS	DESCRIPTION	COLOUR TEMP	LUMENS	PHILIPS	OSRAM	GE
❶ R380DLED	12	Performance LED	7000K	300/100			
❷ R380LED	12	Premium LED	6000K	510/150			
❸ R3803FSLED	12	Filament Style LED	3000K	380/40			
❹ R2943FSLED	24	Filament Style LED	3000K	410/55			

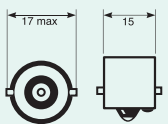
149





**(R5W)
(R10W)**

BA15s (SCC)

LAMP NO	VOLTS	DESCRIPTION	COLOUR TEMP	LUMENS	PHILIPS	OSRAM	GE
❶ R207LED	12	Premium LED	6000K	400			
❷ R2073FSLED	12	Filament Style LED	3000K	60			
❸ R2453FSLED	12	Filament Style LED	3000K	125			
❹ R1496LED	24	Premium LED	6000K	400			
❺ R1506LED	24	Premium LED	6000K	400			
❻ R1493FSLED	24	Filament Style LED	3000K	55			
❼ R2463FSLED	24	Filament Style LED	3000K	110			

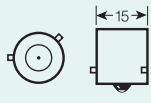
150

(RY10W)

BAU15s (OSP)

LAMP NO	VOLTS	DESCRIPTION	COLOUR TEMP	LUMENS	COLOUR	PHILIPS	OSRAM	GE
R589AFSLED	12	Filament Style LED	2000K	75	●			

Vehicle Lighting

151



(W5W)

W2.1.x9.5d

LAMP NO	VOLTS	DESCRIPTION	COLOUR TEMP	LUMENS	PHILIPS	OSRAM	GE
1 R501DLED	12	Performance LED	7000K	200			
2 R501CBLED	12	Premium LED	6000K	220			
3 R501FSLED	12	Filament Style LED	6000K	60			
4 R5016LED	12	Standard LED	6000K	40			
5 R50112LED	12	Standard LED	12000K	35			
6 R2946FSLED	24	Filament Style LED	6000K	65			

152

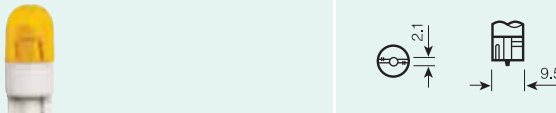

(WY5W)

W2.1.x9.5d

LAMP NO	VOLTS	DESCRIPTION	COLOUR TEMP	LUMENS	COLOUR	PHILIPS	OSRAM	GE
R501AFSLED	12	Filament Style LED	2000K	40	●			

153



(C5W)

S8.5d 11x38mm

LAMP NO	VOLTS	DESCRIPTION	COLOUR TEMP	LUMENS	PHILIPS	OSRAM	GE
1 R239CBLED	12	Premium LED	6000K	200			
2 R239FSLED	12	Filament Style LED	6000K	45			
3 R2396LED	12	Standard LED	6000K	35			
4 R23912LED	12	Standard LED	12000K	35			
5 R2426LED	24	Premium LED	6000K	200			
6 R2426FSLED	24	Filament Style LED	6000K	50			



154





(T4W)

BA9s (MCC)

LAMP NO	VOLTS	DESCRIPTION	COLOUR TEMP	LUMENS	PHILIPS	OSRAM	GE
1 R2336FSLED	12	Filament Style LED	3000K	60			
2 R2496LED	24	Premium LED	6000K	200			

155								B8.5d / BX8.5d	
			LAMP NO	VOLTS	DESCRIPTION	TYPE	COLOUR	PHILIPS	OSRAM
	LED509TB	12	LED	Blue B8.5d	●				
	R508TLED	24	LED	Grey BX8.5D					

156								W2.3W	
			LAMP NO	VOLTS	DESCRIPTION	TYPE	COLOUR	PHILIPS	OSRAM
	LED286B	12	LED	Standard	●				

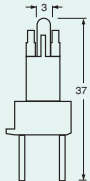
157								Bi-Pin	
			LAMP NO	VOLTS	WATTS	BASE COLOUR	DESCRIPTION	PHILIPS	OSRAM
	R2401LED	24	20mA	Black					

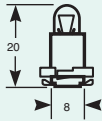
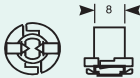
158									BAX EBSR	
				LAMP NO	VOLTS	WATTS	BASE COLOUR	DESCRIPTION	PHILIPS	OSRAM
	R1791LED	24	1.2	Yellow						

Vehicle Lighting

Bus Bulbs

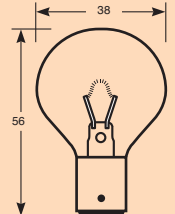
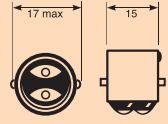
							
	BA15d (SBC)						
LAMP NO	VOLTS	WATTS	GLASS	DESCRIPTION	PHILIPS	OSRAM	GE
R805	12	12	Pearl				
R810	12	24	Pearl				
R817	24	12	Pearl				
R822	24	20	Pearl				

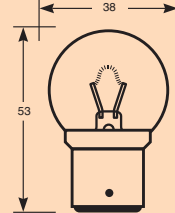
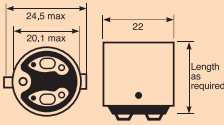
							
	B22d (BC)						
LAMP NO	VOLTS	WATTS	GLASS	DESCRIPTION	PHILIPS	OSRAM	GE
R804	12	12	Pearl				
R809	12	24	Pearl				
R816	24	12	Pearl				
R821	24	20	Pearl				
R1184P	24	22	Pearl				

Halogen Interior Bulbs

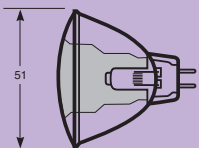
								
	MR16							
LAMP NO	VOLTS	WATTS	ANGLE	DESCRIPTION	PHILIPS	OSRAM	GE	
DLM69E	12	20	36°					

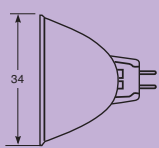
								
	MR11							
LAMP NO	VOLTS	WATTS	ANGLE	DESCRIPTION	PHILIPS	OSRAM	GE	
121030XB	12	10	30°					
A122030	12	20	30°					
A123530	12	35	30°					

163									
LAMP NO	VOLTS	WATTS	ANGLE	DESCRIPTION	PHILIPS	OSRAM	MR16/Dichroic		
74220B	12	10	38°						
A576	24	LED		◆ Ring LED					
A241012	24	10	12°						
A242038	24	20	38°						
A242060	24	20	60°						
A243538	24	35	38°						

164									
LAMP NO	VOLTS	WATTS	ANGLE	DESCRIPTION	PHILIPS	OSRAM	G9		
74214P	240	25							

Fluorescent Tubes

165									
LAMP NO	WATTS	SIZE	DESCRIPTION	DESIGN LIFE	PHILIPS	OSRAM	T5		
A3003	4	6"	White	10000hrs					
A1056	6	9"	White	10000hrs					
61008B	8	1ft	White	7000hrs					
A1001-R	8	1ft	Warm White	10000hrs					
A1002-R	8	1ft	Warm White	10000hrs					
61003B	13	21"	White	7000hrs					
A1038-X	13	21"	White	10000hrs					
A1054	28	4ft	Cool White	30000hrs					
A1058	49	4.75ft	Cool White Deluxe	24000hrs					
A1060	80	4.75ft	Cool White Deluxe	24000hrs					

Vehicle Lighting

166

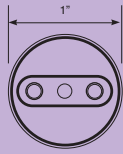

T8

LAMP NO	WATTS	SIZE	DESCRIPTION	DESIGN LIFE	PHILIPS	OSRAM	GE
61012B	15	18"	White	10000hrs			
A1003-R	15	18"	White	15000hrs			
A1047	15/33	18"	Cool White	20000hrs			
61005B	18	2ft	White	12000hrs			
A1019	18	2ft	Daylight	15000hrs			
A1020	18	2ft	Cool White Deluxe	15000hrs			
A1038-R	18	2ft	White Deluxe	15000hrs			
61014B	30	3ft	White	12000hrs			
A1016-R	30	3ft	Warm White Deluxe	15000hrs			
A1049	30	3ft	Daylight	20000hrs			
A1050	36	3ft	Cool White	20000hrs			
61010C	36	4ft	White	12000hrs			
A1021	36	4ft	Cool White Deluxe	15000hrs			
A1051	36	4ft	White Deluxe	15000hrs			
61011C	58	5ft	White	12000hrs			
A1023	58	5ft	Cool White Deluxe	15000hrs			
A1053	58	5ft	White	15000hrs			
61009	70	6ft	White Deluxe	15000hrs			

Halogen Tubes

167

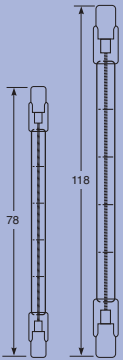



Linear Halogen

LAMP NO	VOLTS	WATTS	ECE NO	DESCRIPTION	PHILIPS	OSRAM	GE
TH50011	110	50					
74199	230	120					
74200	230	230					
74201	230	400					

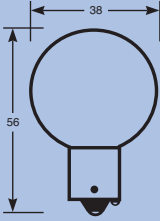
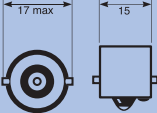

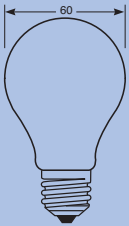



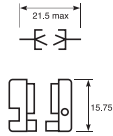

Inspection/Hand Lamp Bulbs

168							
							Rough Service
LAMP NO	VOLTS	WATTS	ECE NO	DESCRIPTION	PHILIPS	OSRAM	GE
R112	12	24		Inspection Lamp Bulb			

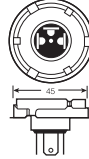
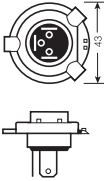
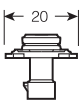
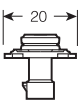
169							
							Rough Service
LAMP NO	VOLTS	WATTS	ECE NO	DESCRIPTION	PHILIPS	OSRAM	GE
R110	12	50		Inspection Lamp Bulb			

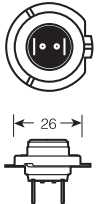
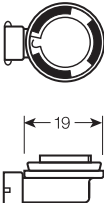
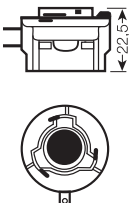
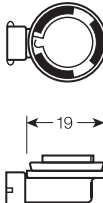
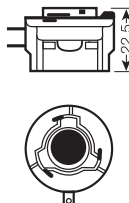

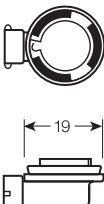
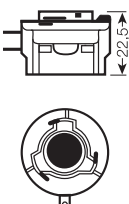
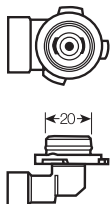
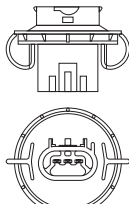
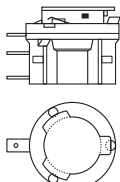
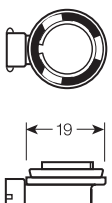

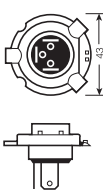
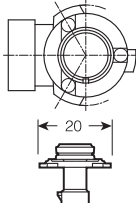
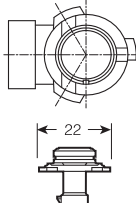





170							
							Fluorescent
LAMP NO	VOLTS	WATTS	ECE NO	DESCRIPTION	PHILIPS	OSRAM	GE
RIL200	12/230	11		Compact Fluorescent			

Vehicle Lighting

				
H1 P14.5s	H2 X511	H3 PK22s	H4 P45t	H4 P43t
				
ECE Cap	HB3A P20d	HB4 P22d	HB4A P22d	H7 PX22d
				
H8 PGJ19-1	H8B PGJY19-1	H9 PGJ19-5	H9B PGJY19-5	H10 PY20d
				
H11 PGJ19-2	H11B PGJY19-2	H12 PZ20d	H13 P26.4t	H15 PGJ23t-1
				
H16 PGJ19-3	H18 PY26d	H19 PU43t-3	HIR1 PX20d	HIR2 PX22d

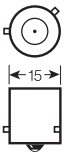
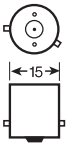
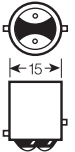
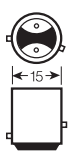
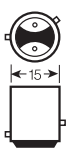
D1S PK32d-2	D1R PK32d-3	D2S P32d-2	D2R P32d-3	D3S PK32d-5
D3R PK32d-6	D4S P32d-5	D4R P32d-6	D5S	D8S PK32d-1
S2 BA20D	S3 P26s	PX15D	P15D-3	P15D-25-3
H27W1 PG13	H27W2 PGJ13	P36t	HB1 P29t	HB5 PX29t
MH6R P30t-40	P30/22L	H3r PK22sr	R2 P45t ASY UEC	S1 S2 BA20d (Bosch)

Vehicle Lighting

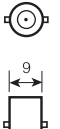
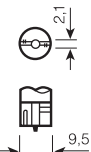
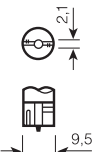
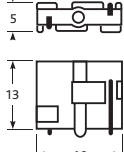
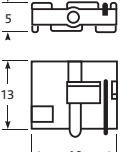
				
P36d	P36d Axial	P36d Tranverse	P36s Axial	P36s Tranverse
				
P21W BA15s (SCC)	PY21W BAU15s (OSP)	PR21W BAW15s	P21W BA15d (SBC)	BA15d (SBC)
				
P21/5W BAY15d (OSP)	PR21/5W BAW15d	P21/4W BAZ15d	R5W BA15s (SCC)	R10W BA15s (SCC)
				
RY10W BAU15s (SCC)	R5W BA15d (SBC)	BAY15d (OSP)	T4W BA9s (MCC)	BA9s (MCC)
				
W3W W2.1 x 9.5d	W5W W2.1 x 9.5d	W16W W2.1 x 9.5d	W21W W3 x 16d	WY21W W3 x 16d

W21/5W W3 x 16q	P27W WY2.5x 16d	P27/7W W2.5 x 16q	PSX26W	C5W S8.5d
C21W S8.5d	S6d / S7d	BA9s (MCC)	H6W BAX9s (MCC)	H21W BAY9s (MCC)
BA15d (SBC)	BA15s (SCC)	G4	W2.3W W2 x 4.6d	WY2.3W WX2 x 4.6d
E10/13/13 MES	E10/13 MES	E5/8 LESBX8.5D	BA7s Peanut	B8.4D / BX8.4D
				<p>Panel thickness B = 2mm BX = 1.5mm</p>
B8.5D / BX8.5D	F4.8	B8.3D	BAX EBSR	B10d

Vehicle Lighting

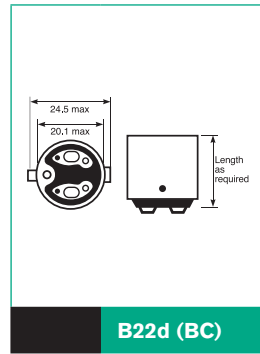
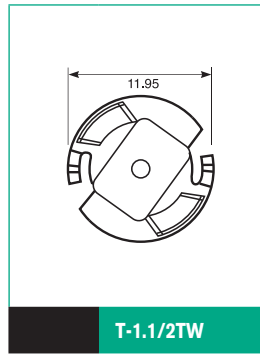
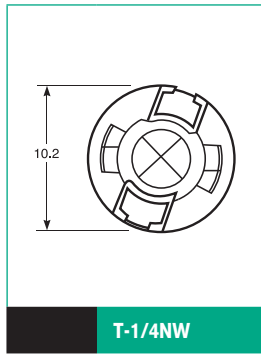
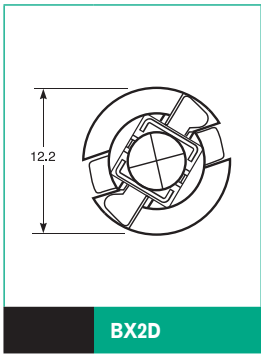

Cap References

- SCC Single Centre Contact
- MCC Miniature Centre Contact
- MES Miniature Edison Screw
- OSP Offset Pin
- SBC Small Bayonet Cap
- ES Edison Screw
- BC Bayonet Cap
- SES Small Edison Screw
- LES Lilliput Edison Screw

ECE	PART NO.	VOLTS	WATTS	CAP	SIZE	DIAGRAM	DESCRIPTION
C5W	RTM242	24	5	S8.5d	11 x 38mm	96	TruckMaster Festoon
C5W	R239	12	5	S8.5d	11 x 38mm	96	Festoon
C5W	R239LL	12	5	S8.5d	11 x 38mm	96	Long Life Festoon
C5W	R242	24	5	S8.5d	11 x 38mm	96	Festoon
C5W	R253	6	5	S8.5d	11 x 38mm	96	Festoon
(C5W)	R23912LED	12		S8.5d	11 x 38mm	153	Ring Standard LED Festoon - 12000K
(C5W)	R2396LED	12		S8.5d	11 x 38mm	153	Ring Standard LED Festoon - 6000K
(C5W)	R239CBLLED	12		S8.5d	11 x 38mm	153	Ring Premium LED Festoon - 6000K
(C5W)	R239CBLLED	24		S8.5d	11 x 38mm	153	Ring Premium LED Festoon - 6000K
(C5W)	R239FSLLED	12		S8.5d	11 x 38mm	153	Ring Filament Style LED Festoon - 6000K
(C5W)	R2426FSLLED	24		S8.5d	11 x 38mm	153	Ring Filament Style LED Festoon - 6000K
C21W	R273	12	21	S8.5d	15 x 44mm	97	Festoon
D1R	R85406	85	35	PK32d-3	9mm	27	Gas Discharge Headlamp
D1S	R85402	85	35	PK32d-2	9mm	26	Gas Discharge Headlamp
D1S	R85402100	85	35	PK32d-2	9mm	26	Gas Discharge Headlamp - 5500K +20%
D1S	R854025K	85	35	PK32d-2	9mm	26	Gas Discharge Headlamp - 5500K +20%
D2R	R851265	85	35	P32d-3	9mm	29	Gas Discharge Headlamp
D2R	R851265K	85	35	P32d-3	9mm	29	Gas Discharge Headlamp - 5500K +20%
D2S	R85122	85	35	P32d-2	9mm	28	Gas Discharge Headlamp
D2S	R85122100	85	35	P32d-2	9mm	28	Gas Discharge Headlamp +100%
D2S	R851225K	85	35	P32d-2	9mm	28	Gas Discharge Headlamp - 5500K +20%
D3R	R42306	42	35	PK32d-6	9mm	31	Gas Discharge Headlamp
D3S	R42302	42	35	PK32d-5	9mm	30	Gas Discharge Headlamp
D3S	R423025K	42	35	PK32d-5	9mm	30	Gas Discharge Headlamp - 5500K +20%
D4R	R42406	42	35	P32d-6	9mm	33	Gas Discharge Headlamp
D4S	R42402	42	35	P32d-5	9mm	32	Gas Discharge Headlamp
D4S	R424025K	42	35	P32d-5	9mm	32	Gas Discharge Headlamp - 5500K +20%
D5S	R12410	12/24	25	PK32d-7		34	Gas Discharge Headlamp
D8S	R66548	40	25	PK32d-1		35	Gas Discharge Headlamp
H1	R1548	12	55	P14.5s	10mm	1	Ring Xenon150 Halogen Headlamp
H1	R3348	12	55	P14.5s	10mm	1	Ring Xenon130 Halogen Headlamp
H1	R4448	12	55	P14.5s	10mm	1	Ring Xenon4400 Halogen Headlamp
H1	R848	12	55	P14.5s	10mm	1	Ring XenonPlus Halogen Headlamp
H1	R948	12	55	P14.5s	10mm	1	Ring UltraXenon Halogen Headlamp
H1	RTM466	24	70	P14.5s	10mm	1	TruckMaster Halogen Headlamp
H1	RTM466HDLL	24	70	P14.5s	10mm	1	TruckMaster Heavy Duty Long Life Halogen Headlamp
H1	R1048	12	55	P14.5s	10mm	1	Ring XenonMax Halogen Headlamp
H1	R448	12	55	P14.5s	10mm	1	Halogen Headlamp
H1	R448HD	12	55	P14.5s	10mm	1	Heavy Duty Halogen Headlamp
H1	R448LL	12	55	P14.5s	10mm	1	Long Life Halogen Headlamp
H1	R465	6	55	P14.5s	10mm	1	Halogen Headlamp
H1	R466	24	70	P14.5s	10mm	1	Halogen Headlamp
H1	R466HD	24	70	P14.5s	10mm	1	Heavy Duty Halogen Headlamp
H1	R5048	12	55	P14.5s	10mm	1	Ring Xenon5000 Halogen Headlamp
(H1)	R481	12	100	P14.5s	10mm	1	Ring Rally Sport High Wattage Halogen Headlamp
(H1)	R493	24	100	P14.5s	10mm	1	High Wattage Halogen Headlamp
(H1)	R499	12	130	P14.5s	10mm	1	Ring Rally Sport High Wattage Halogen Headlamp
(H1)	R668	12	80	P14.5s	10mm	1	Ring SportzBlue Headlamp
H1A	R448EQ	12	55	P14.5s	10mm	1	EQ Halogen Headlamp
(H2)	R482	24	70	X511	9mm	2	High Wattage Halogen Accessory Lamp
(H2)	R479	12	55	X511	9mm	2	Halogen Accessory Lamp
(H2)	R480	12	100	X511	9mm	2	Ring Rally Sport High Wattage Halogen Accessory Lamp
(H2)	R491	12	130	X511	9mm	2	Ring Rally Sport High Wattage Halogen Accessory Lamp
(H2)	R494	24	100	X511	9mm	2	Ring Rally Sport High Wattage Halogen Accessory Lamp
H3	RTM460	24	70	PK22s	11.5mm	3	TruckMaster Halogen Accessory Lamp
H3	RTM460HDLL	24	70	PK22s	11.5mm	3	TruckMaster Heavy Duty & Long Life Halogen Accessory Lamp
H3	R1053	12	55	PK22s	11.5mm	3	Ring XenonMax Halogen Headlamp
H3	R453	12	55	PK22s	11.5mm	3	Halogen Accessory Lamp
H3	R453LL	12	55	PK22s	11.5mm	3	Long Life Halogen Accessory Lamp
H3	R455	6	55	PK22s	11.5mm	3	Halogen Accessory Lamp
H3	R460	24	70	PK22s	11.5mm	3	Halogen Accessory Lamp
H3	R460HD	24	70	PK22s	11.5mm	3	Heavy Duty Halogen Accessory Lamp
(H3)	R441	36	45	PK22s	11.5mm	3	Halogen Accessory Lamp
(H3)	R442	48	45	PK22s	11.5mm	3	Halogen Accessory Lamp
(H3)	R443	80	55	PK22s	11.5mm	3	Halogen Accessory Lamp
(H3)	R444	24	50	PK22s	11.5mm	3	Halogen Accessory Lamp
(H3)	R445	12	10	PK22s	11.5mm	3	Halogen Accessory Lamp
(H3)	R446	12	20	PK22s	11.5mm	3	Halogen Accessory Lamp
(H3)	R449	24	35	PK22s	11.5mm	3	Halogen Accessory Lamp
(H3)	R456	6	15	PK22s	11.5mm	3	Halogen Accessory Lamp

Vehicle Lighting

ECE	PART NO.	VOLTS	WATTS	CAP	SIZE	DIAGRAM	DESCRIPTION
(H3)	R457	6	25	PK22s	11.5mm	3	Halogen Accessory Lamp
(H3)	R461	24	65	PK22s	11.5mm	3	Halogen Accessory Lamp
(H3)	R462	12	35	PK22s	11.5mm	3	Halogen Accessory Lamp
(H3)	R483	12	100	PK22s	11.5mm	3	Ring Rally Sport High Wattage Halogen Accessory Lamp
(H3)	R492	12	130	PK22s	11.5mm	3	Ring Rally Sport High Wattage Halogen Accessory Lamp
(H3)	R495	24	100	PK22s	11.5mm	3	Ring Rally Sport High Wattage Halogen Accessory Lamp
H3C	R447	12	55	PK22s	11.5mm	52	Halogen Accessory Lamp
H3C	R960	12	55(85)	P22d/5	12mm	52	Halogen Headlamp Import - 556
H3r	R961	12	55	PK22sr	12mm	50	Halogen Headlamp Import - 453
H4	R012	12	60/55	P45t H4 UEC	17mm	4	Halogen Headlamp
H4	R1572	12	60/55	P43t	17mm	5	Ring Xenon150 Halogen Headlamp
H4	R3372	12	60/55	P43t	17mm	5	Ring Xenon130 Halogen Headlamp
H4	R4072	12	60/55	P43t	17mm	5	Ring Xenon4000 Halogen Headlamp
H4	R4472	12	60/55	P43t	17mm	5	Ring Xenon4400 Halogen Headlamp
H4	R496	24	100/80	P43t	17mm	5	Ring Rally Sport High Wattage Halogen Headlamp
H4	R498	24	130/90	P43t	17mm	5	Ring Rally Sport High Wattage Halogen Headlamp
H4	R872	12	60/55	P43t	17mm	5	Ring XenonPlus Halogen Headlamp
H4	R905	6	60/55	P43t H4	17mm	5	Halogen Headlamp
H4	R972	12	60/55	P43t	17mm	5	Ring UltraXenon Halogen Headlamp
H4	RTM475	24	75/70	P43t	17mm	5	TruckMaster Halogen Headlamp
H4	RTM475HDLL	24	75/70	P43t	17mm	5	TruckMaster Heavy Duty Long Life Halogen Headlamp
H4	R1072	12	60/55	P43t	17mm	5	Ring XenonMax Halogen Headlamp
H4	R472	12	60/55	P43t	17mm	5	Halogen Headlamp
H4	R472EL	12	60/55	P43t	17mm	5	Extra Life Halogen Headlamp
H4	R472EQ	12	60/55	P43t	17mm	5	EQ Halogen Headlamp
H4	R472HD	12	60/55	P43t	17mm	5	Heavy Duty Halogen Headlamp
H4	R472LL	12	60/55	P43t	17mm	5	Long Life Halogen Headlamp
H4	R475	24	75/70	P43t	17mm	5	Halogen Headlamp
H4	R475HD	24	75/70	P43t	17mm	5	Heavy Duty Halogen Headlamp
H4	R5072	12	60/55	P43t	17mm	5	Ring Xenon5000 Halogen Headlamp
(H4)	R024	24	75/70	P45t H4 UEC	17mm	4	Halogen Headlamp
(H4)	R473	12	100/55	P43t	17mm	5	Ring Rally Sport High Wattage Halogen Headlamp
(H4)	R484	12	100/80	P43t	17mm	5	Ring Rally Sport High Wattage Halogen Headlamp
(H4)	R485	12	100/80	P45t	17mm	4	Ring Rally Sport High Wattage Halogen Headlamp
(H4)	R490	12	130/90	P43t	17mm	5	Ring Rally Sport High Wattage Halogen Headlamp
(H4)	R497	24	100/80	P45t	17mm	4	Ring Rally Sport High Wattage Halogen Headlamp
(H4)	R590	12	160/100	P43t	17mm	5	Ring Rally Sport High Wattage Halogen Headlamp
(H4)	R591	12	130/90	P45t	17mm	4	Ring Rally Sport High Wattage Halogen Headlamp
(H4)	R684	12	100/80	P43t	17mm	5	Ring SportzBlue Headlamp
(H4)	R911	12	45/40	P43t	17mm	5	Halogen Headlamp
H6W	R834	12	6	BAX9s	9mm	100	Ring IceBlue Side & Tail
H6W	R434	12	6	BAX9s	9mm	100	Miniature Halogen
HY6W	R926	12	6	BAZ9s	9mm	101	Miniature Halogen - Amber
H7	R1577	12	55	PX26d	11.6mm	10	Ring Xenon150 Halogen Headlamp
H7	R3377	12	55	PX26d	11.6mm	10	Ring Xenon130 Halogen Headlamp
H7	R4077	12	55	PX26d	11.6mm	10	Ring Xenon4000 Halogen Headlamp
H7	R4477	12	55	PX26d	11.6mm	10	Ring Xenon4400 Halogen Headlamp
H7	R877	12	55	PX26d	11.6mm	10	Ring XenonPlus Halogen Headlamp
H7	R977	12	55	PX26d	11.6mm	10	Ring UltraXenon Halogen Headlamp
H7	RTM474	24	70	PX26d	11.6mm	10	TruckMaster Halogen Headlamp
H7	RTM474HDLL	24	70	PX26d	11.6mm	10	TruckMaster Heavy Duty Long Life Halogen Headlamp
H7	R1077	12	55	PX26d	11.6mm	10	Ring XenonMax Halogen Headlamp
H7	R474	24	70	PX26d	11.6mm	10	Halogen Headlamp
H7	R474HD	24	70	PX26d	11.6mm	10	Heavy Duty Halogen Headlamp
H7	R477	12	55	PX26d	11.6mm	10	Halogen Headlamp
H7	R477EL	12	55	PX26d	11.6mm	10	Extra LifeHalogen Headlamp
H7	R477EQ	12	55	PX26d	11.6mm	10	EQ Halogen Headlamp
H7	R477LL	12	55	PX26d	11.6mm	10	Long Life Halogen Headlamp
H7	R5077	12	55	PX26d	11.6mm	10	Ring Xenon5000 Halogen Headlamp
(H7)	R454	24	100	PX26d	11.6mm	10	High Wattage Halogen Headlamp
(H7)	R464	12	100	PX26d	11.6mm	10	Ring Rally Sport High Wattage Halogen Headlamp
(H7)	R477FLED	12		PX26d	18mm	144	Ring Premium LED Fog Light
(H7)	R664	12	80	PX26d	11.6mm	10	Ring SportzBlue Headlamp
H8	R708	12	35	PGJ19-1	11.6mm	11	Halogen Headlamp
H8B	R920	12	35	PGJY19-1	15mm	12	Halogen Headlamp
H9	R709	12	65	PGJ19-5	11.6mm	13	Halogen Headlamp
H9B	R919	12	65	PGJY19-5	15mm	14	Halogen Headlamp
H10	R710	12	42	PY20d	16mm	15	Halogen Headlamp
H11	R458HD	24	70	PGJ19-2	11.6mm	16	Heavy Duty Halogen Headlamp
H11	R1011	12	55	PGJ19-2	11.6mm	16	Ring XenonMax Halogen Headlamp

ECE	PART NO.	VOLTS	WATTS	CAP	SIZE	DIAGRAM	DESCRIPTION
H11	R1511	12	55	PGJ19-2	11.6mm	16	Ring Xenon150 Halogen Headlamp
H11	R3311	12	55	PGJ19-2	11.6mm	16	Ring Xenon130 Halogen Headlamp
H11	R4011	12	55	PGJ19-2	11.6mm	16	Ring Xenon4000 Halogen Headlamp
H11	R458	24	70	PGJ19-2	11.6mm	16	Halogen Headlamp
H11	RTM458HDLL	24	70	PGJ19-2	11.6mm	16	TruckMaster Heavy Duty Long Life Halogen Headlamp
H11	R5011	12	55	PGJ19-2	11.6mm	16	Ring Xenon5000 Halogen Headlamp
H11	R711	12	55	PGJ19-2	11.6mm	16	Halogen Headlamp
H11	R711LL	12	55	PGJ19-2	11.6mm	16	Long Life Halogen Headlamp
(H11)	R711FLED	12		PGJ19-2	18mm	145	Ring Premium LED Fog Light
H11B	R924	12	55	PGJY19-2	22.5mm	17	Halogen Headlamp
H12	R712	12	53	PZ20d	16mm	18	Halogen Headlamp
H13	R9008	12	60/55	P26.4t	16mm	19	Halogen Headlamp
H15	R715	12	55/15	PGJ26t-1	22mm	20	Halogen Headlamp
H16	R716	12	19	PGJ19-3	11.6mm	21	Halogen Headlamp
H18	R718	12	55	PY26d	15mm	22	Halogen Headlamp
H19	R719	12	60/55	PU43t-3	22mm	23	Halogen Headlamp
(HB1)	R9004	12	65/45	P29t	14.7mm	48	Halogen Headlamp
(HB1)	R8004	12	65/45	P29t	14.7mm	48	Ring XenonPlus Halogen Headlamp
HB2	R9003	12	60/55	P43t	17mm	5	Halogen Headlamp
HB3	R1005	12	60	P20d	12mm	6	Ring XenonMax Halogen Headlamp
HB3	R9005	12	60	P20d	12mm	6	Halogen Headlamp
HB3	R9905	12	60	P20d	12mm	6	Ring UltraXenon Halogen Headlamp
HB3	R3005	12	60	P20d	12mm	6	Ring IceBlue Halogen Headlamp
HB3	R8005	12	60	P20d	12mm	6	Ring XenonPlus Halogen Headlamp
HB3A	R9005XS	12	60	P20d	12mm	7	Halogen Headlamp
HB4	R1006	12	51	P22d	12mm	8	Ring XenonMax Halogen Headlamp
HB4	R3306	12	51	P22d	12mm	8	Ring Xenon130 Halogen Headlamp
HB4	R9006	12	51	P22d	12mm	8	Halogen Headlamp
HB4	R9906	12	51	P22d	12mm	8	Ring UltraXenon Halogen Headlamp
HB4	R8006	12	51	P22d	12mm	8	Ring XenonPlus Halogen Headlamp
HB4A	R9006XS	12	51	P22d	12mm	9	Halogen Headlamp
(HB5)	R8007	12	65/55	PX29t	14.7mm	48	Ring XenonPlus Halogen Headlamp
(HB5)	R9007	12	65/55	PX29t	33.8mm	48	Halogen Headlamp
HIR1	R9011	12	65	PX20d	20mm	24	Halogen Headlamp
HIR2	R9012	12	55	PX22d	20mm	25	Halogen Headlamp
HS1	R459	12	35/35	PX43t	17mm	5	Halogen Headlamp
HS1	R910	6	35/35	PX43t	17mm	5	Halogen Headlamp
HS5	R929	12	35/30	P23t	25mm	36	Motorcycle Headlamp
H21W	R435	12	21	BAY9s	9mm	103	Miniature Halogen Brake/Indicator/Reverse/Rear Fog
H21W	R535	24	21	BAY9s	9mm	103	Miniature Halogen Brake/Indicator/Reverse/Rear Fog
H21W	RTM535	24	21	BAY9s	9mm	103	Truckmaster Miniature Halogen Brake/Indicator/Reverse/Rear Fog
H27W/1	R880	12	27	PG13	9mm	43	Halogen Headlamp
H27W/2	R881	12	27	PGJ13	9mm	44	Halogen Headlamp
HY21W	R927	12	21	BAW9s	9mm	104	Miniature Halogen - Amber
P13W	R12277	12	13	PG18.5d-1	20mm	90	HiPervision Day Time Running
P21/4W	R566	12	21/4	BAZ15d	25mm	70	Fog/Tail
P21/4W	R567	24	21/4	BAZ15d	25mm	70	Fog/Tail
P21/5W	R294	24	21/5	BAY15d (OSP)	25mm	68	Brake/Tail
P21/5W	RTM294	24	21/5	BAY15d (OSP)	25mm	68	TruckMaster Brake/Tail
P21/5W	R380	12	21/5	BAY15d (OSP)	25mm	68	Brake/Tail
P21/5W	R380HD	12	21/5	BAY15d (OSP)	25mm	68	Heavy Duty Brake/Tail
P21/5W	R380LL	12	21/5	BAY15d (OSP)	25mm	68	Long Life Brake/Tail
P21/5W	R380RR	12	21/5	BAY15d (OSP)	25mm	68	Rapid Response Brake/Tail
P21/5W	R384	6	21/5	BAY15d (OSP)	25mm	68	Brake/Tail
(P21/5W)	R2946FSLED	24		BAY15d (OSP)	25mm	148	Ring Performance LED Brake/Tail - 3000K
(P21/5W)	R3803FSLED	12		BAY15d (OSP)	25mm	148	Ring Filament Style LED Brake/Tail - 3000K
(P21/5W)	R380DLED	12		BAY15d (OSP)	25mm	148	Ring Performance LED Brake/Tail - 7000K
(P21/5W)	R380LED	12		BAY15d (OSP)	25mm	148	Ring Premium LED Brake/Tail - 6000K
P21W	RTM241	24	21	BA15s (SCC)	25mm	63	TruckMaster Brake/Indicator/Reverse/Rear Fog
P21W	RTM241HDLL	24	21	BA15s (SCC)	25mm	63	TruckMaster Heavy Duty Long Life Brake/Indicator/Reverse/Rear Fog
P21W	RTM346	24	21	BA15d (SBC)	25mm	66	TruckMaster Brake/Indicator/Reverse/Rear Fog
P21W	RTM346HDLL	24	21	BA15d (SBC)	25mm	66	TruckMaster Heavy Duty & Long Life Brake/Indicator/Reverse/Rear Fog
P21W	R241	24	21	BA15s (SCC)	25mm	63	Brake/Indicator/Reverse/Rear Fog
P21W	R290	24	21	BA15s (SCC)	25mm	63	Heavy Duty Brake/Indicator/Reverse/Rear Fog
P21W	R291	24	21	BA15d (SBC)	25mm	66	Heavy Duty Brake/Indicator/Reverse/Rear Fog
P21W	R317	6	21	BA15s (SCC)	25mm	63	Brake/Indicator/Reverse/Rear Fog
P21W	R319	6	21	BA15d (SBC)	25mm	66	Brake/Indicator/Reverse/Rear Fog
P21W	R335	12	21	BA15d (SBC)	25mm	66	Brake/Indicator/Reverse/Rear Fog
P21W	R346	24	21	BA15d (SBC)	25mm	66	Brake/Indicator/Reverse/Rear Fog
P21W	R382	12	21	BA15s (SCC)	25mm	63	Brake/Indicator/Reverse/Rear Fog

Vehicle Lighting

ECE	PART NO.	VOLTS	WATTS	CAP	SIZE	DIAGRAM	DESCRIPTION
P21W	R382HD	12	21	BA15s (SCC)	25mm	63	Heavy Duty Brake/Indicator/Reverse/Rear Fog
P21W	R382LL	12	21	BA15s (SCC)	25mm	63	Long Life Brake/Indicator/Reverse/Rear Fog
P21W	R382RR	12	21	BA15s (SCC)	25mm	63	Rapid Response Brake/Indicator/Reverse/Rear Fog
(P21W)	R2413FSLED	24		BA15s (SCC)	25mm	146	Ring Filament Style LED Brake/Indicator/Reverse/Rear Fog 3000K
(P21W)	R2416LED	24		BA15s (SCC)	25mm	146	Ring Premium LED Brake/Indicator/Reverse/Rear Fog 6000K
(P21W)	R3823FSLED	12		BA15s (SCC)	25mm	146	Ring Filament Style LED Brake/Indicator/Reverse/Rear Fog 3000K
(P21W)	R382DLED	12		BA15s (SCC)	25mm	146	Ring Performance LED Brake/Indicator/Reverse/Rear Fog 7000K
(P21W)	R382LED	12		BA15s (SCC)	25mm	146	Ring Premium LED Brake/Indicator/Reverse/Rear Fog 6000K
P24W	R928	12	24	PU20-3	18mm	94	HiPervision Brake/Indicator/Reverse/Rear Fog
P27/7W	R180	12	21/7	W2.5 x 16q	25.5mm	88	Brake & Tail
P27W	R182	12	27	W2.5 x 16d	25.5mm	87	Brake/Indicator/Reverse/Rear Fog
PC16WY	R925	12	16	PU20d-2	20mm	90	Hipervision Indicator - Amber
PR21/5W	R3780	12	21/5	BAW15d	25mm	69	Brake/Tail - Silver Red
PR21/5W	R780	12	21/5	BAW15d	25mm	69	Brake & Tail - Red
PR21W	R3782	12	21	BAW15s	25mm	65	Brake-Silver Red
PR21W	R782	12	21	BAW15s	25mm	65	Brake - Red
PS19W	R12085	12	19	PG20-1	16mm	91	HiPervision Brake/Indicator/Reverse/Rear Fog
PS24W	R12086	12	24	PG20-3	16mm	92	HiPervision Brake/Indicator/Reverse/Rear Fog
PSX24W	R12276	12	24	PG20-7	16mm	92	HiPervision Brake/Indicator/Reverse/Rear Fog
PSX26W	R12278	12	26	PG18.5d-3	18mm	95	HiPervision Brake/Indicator/Reverse/Rear Fog
PSY19W	R12275	12	19	PG20-2	16mm	91	HiPervision Indicator - Amber
PSY24W	R12188	12	24	PG20-4	16mm	92	HiPervision Indicator - Amber
PW24W	R12182	12	24	WP3.3x14.5-3		93	HiPervision Brake/Indicator/Reverse/Rear Fog
PY21W	RTM588	24	21	BAU15s (OSP)	25mm	64	TruckMaster Indicator - Amber
PY21W	RTM588HDLL	24	21	BAU15s (OSP)	25mm	64	TruckMaster Heavy Duty Long Life Indicator - Amber
PY21W	R3581	12	21	BAU15s (OSP)	25mm	64	Indicator - Silver Amber
PY21W	R581	12	21	BAU15s (OSP)	25mm	64	Indicator - Amber
PY21W	R581HD	12	21	BAU15s (OSP)	25mm	64	Heavy Duty Indicator - Amber
PY21W	R581LL	12	21	BAU15s (OSP)	25mm	64	Long Life Indicator - Amber
PY21W	R588	24	21	BAU15s (OSP)	25mm	64	Indicator - Amber
(PY21W)	R581AFSLED	12		BAU15s (OSP)	25mm	147	Ring Filament Style LED Indicator Amber- 2000K
PY24W	R12190	12	24	PGU20-4	16mm	92	HiPervision Indicator - Amber
PY24W	R12274	12	24	PGU20-4	16mm	92	HiPervision Indicator - Silver Amber
PY24W	R12274HTR	12	24	WP3.3X14.5-4	18mm	93	HiPervision Indicator - Amber
PY27/7W	R183	12	27/7	WX2.5 x 16q	25.5mm	89	HiPervision Indicator - Amber
R2	R410	12	45/40	P45t	40mm	53	Headlamp
R2	R423	6	45/40	P45t	40mm	53	Headlamp
R2	R429	24	55/50	P45t	40mm	53	Headlamp
R2	R904	12	45/40	P45t	17mm	4	Halogen Headlamp
R5W	RTM149	24	5	BA15s (SCC)	16mm	71	TruckMaster Side & Tail
R5W	RTM149HDLL	24	5	BA15s (SCC)	16mm	71	TruckMaster Heavy Duty Long Life Side & Tail
R5W	RTM150	24	5	BA15d (SBC)	16mm	73	TruckMaster Side & Tail
R5W	RTM150HDLL	24	5	BA15d (SBC)	16mm	73	TruckMaster Heavy Duty Long Life Side & Tail
R5W	R149	24	5	BA15s (SCC)	16mm	71	Side & Tail
R5W	R150	24	5	BA15d (SBC)	18mm	73	Side & Tail
R5W	R205	6	5	BA15s (SCC)	16mm	71	Side & Tail
R5W	R206	6	5	BA15d (SBC)	18mm	73	Side & Tail
R5W	R207	12	5	BA15s (SCC)	16mm	71	Side & Tail
R5W	R207LL	12	5	BA15s (SCC)	16mm	71	Long Life Side & Tail
R5W	R207RR	12	5	BA15s (SCC)	16mm	71	Rapid Response Side & Tail
R5W	R209	12	5	BA15d (SBC)	16mm	73	Side & Tail
R5W	R247	24	5	BA15d (SBC)	16mm	73	Heavy Duty Side & Tail
R5W	R248	24	5	BA15s (SCC)	16mm	71	Heavy Duty Side & Tail
(R5W)	R1493FSLED	24		BA15s (SCC)	18mm	149	Ring Filament Style LED Side & Tail - 3000K
(R5W)	R1496LED	24		BA15s (SCC)	18mm	149	Ring Premium LED Side & Tail - 6000K
(R5W)	R1506LED	24		BA15d (SBC)	18mm	149	Ring Premium LED Side & Tail - 6000K
(R5W)	R2073FSLED	12		BA15s (SCC)	18mm	149	Ring Filament Style LED Side & Tail - 3000K
(R5W)	R207LED	12		BA15s (SCC)	18mm	149	Ring Premium LED Side & Tail - 6000K
R10W	RTM246	24	10	BA15s (SCC)	18mm	71	TruckMaster Side & Tail
R10W	RTM246HDLL	24	10	BA15s (SCC)	18mm	71	TruckMaster Heavy Duty Long Life Side & Tail
R10W	R244	6	10	BA15s (SCC)	16mm	71	Side & Tail
R10W	R245	12	10	BA15s (SCC)	16mm	71	Side & Tail
R10W	R245LL	12	10	BA15s (SCC)	16mm	71	Long Life Side & Tail
R10W	R245RR	12	10	BA15s (SCC)	16mm	71	Rapid Response Side & Tail
R10W	R246	24	10	BA15s (SCC)	16mm	71	Side & Tail
R10W	R295	24	10	BA15s (SCC)	16mm	71	Heavy Duty Side & Tail
(R10W)	R2453FSLED	12		BA15s (SCC)	18mm	149	Ring Filament Style LED Side & Tail - 3000K
(R10W)	R2463FSLED	24		BA15s (SCC)	18mm	149	Ring Filament Style LED Side & Tail - 3000K
RY10W	R589	12	10	BA15s (SCC)	18mm	72	Indicator - Amber
(RY10W)	R589AFSLED	12		BAU15s (OSP)	18mm	150	Ring Filament Style LED Indicator Amber- 2000K

ECE	PART NO.	VOLTS	WATTS	CAP	SIZE	DIAGRAM	DESCRIPTION
S1	R392	6	25/25	BA20d Bosch	35mm	56	Headlamp
S1	R394	12	25/25	BA20d Bosch	35mm	56	Headlamp
S2	R393	6	35/35	BA20d Bosch	35mm	56	Headlamp
S2	R395	12	35/35	BA20d Bosch	35mm	56	Headlamp
S2	R417	12	35/35	BA20d Bosch	14mm	42	Halogen Headlamp
S3	R609	6	15	P26s	25mm	37	Headlamp
S3	R610	12	15	P26s	25mm	37	Headlamp
S3	R907	12	15	P26s	25mm	38	Headlamp
T4W	R833	12	4	BA9s (MCC)	Tub.9mm	75	Ring IceBlue Side & Tail
T4W	RTM249	24	4	BA9s (MCC)	Tub.9mm	75	TruckMaster Side & Tail
T4W	RTM249HDLL	24	4	BA9s (MCC)	Tub.9mm	75	TruckMaster Heavy Duty Long Life Side & Tail
T4W	R233	12	4	BA9s (MCC)	9mm	75	Side & Tail
T4W	R233LL	12	4	BA9s (MCC)	9mm	75	Long Life Side & Tail
T4W	R249	24	4	BA9s (MCC)	9mm	75	Side & Tail
T4W	R293	6	4	BA9s (MCC)	9mm	75	Side & Tail
T4W	R296	24	4	BA9s (MCC)	9mm	75	Heavy Duty Side & Tail
(T4W)	R2336FSLED	12		BA9s	10mm	154	Ring Filament Style LED Side & Tail - 3000K
(T4W)	R2496LED	24		BA9s	10mm	154	Ring Premium LED Side & Tail - 6000K
W10W	R930	12	10	W2.1 x 9.5d	14mm	80	Side & Tail/Panel/Interior
W16W	R955	12	16	W2.1 x 9.5d	16mm	82	Brake/Indicator/Reverse/Rear Fog
W2.3W	R284	12	2.3	W2 x 4.6d	5mm	108	Panel
(W2.3W)	LED286B	12		B8.5d	5mm	156	Ring Standard LED - Blue
W21/5W	R580	12	21/5	W3 x 16q	20.5mm	86	Brake/Tail
W21/5W	R883	12	21/5	W3 x 16q	20.5mm	86	Xenon4000 Brake/Tail
W21W	R582	12	21	W3 x 16d	20.5mm	84	Brake/Indicator/Reverse/Rear Fog
W21W	R882	12	21	W3 x 16d	20.5mm	84	Xenon4000 Brake/Indicator/Reverse/Rear Fog
W3W	RTM505	24	3	W2.1 x 9.5d	10mm	77	TruckMaster Side & Tail /Panel/ Interior
W3W	R504	12	3	W2.1 x 9.5d	10mm	77	Side & Tail/Panel/Interior
W3W	R505	24	3	W2.1 x 9.5d	10mm	77	Side & Tail/Panel/Interior
W5W	R1401	12	5	W2.1 x 9.5d	10mm	77	Ring Xenon4400 Side & Tail
W5W	R501HD	12	5	W2.1 x 9.5d	10mm	77	Heavy Duty Side & Tail
W5W	R501RR	12	5	W2.1 x 9.5d	10mm	77	Rapid Response Side & Tail
W5W	RTM507	24	5	W2.1 x 9.5d	10mm	77	TruckMaster Side & Tail /Panel/ Interior
W5W	R501	12	5	W2.1 x 9.5d	10mm	77	Side & Tail/Panel/Interior
W5W	R501LL	12	5	W2.1 x 9.5d	10mm	77	Long Life Side & Tail
W5W	R507	24	5	W2.1 x 9.5d	10mm	77	Side & Tail/Panel/Interior
W5W	R801	12	5	W2.1 x 9.5d	10mm	77	Ring IceBlue Side & Tail/ Interior
(W5W)	R2943FSLED	24		W2.1 x 9.5d	10mm	151	Ring Filament Style LED Side & Tail - 6000K
(W5W)	R50112LED	12		W2.1 x 9.5d	10mm	151	Ring Standard LED Side & Tail - 12000K
(W5W)	R5016FSLED	12		W2.1 x 9.5d	10mm	151	Ring Filament Style LED Side & Tail - 6000K
(W5W)	R5016LED	12		W2.1 x 9.5d	10mm	151	Ring Standard LED Side & Tail - 6000K
(W5W)	R501AFSLED	12		W2.1 x 9.5d	10mm	152	Ring Filament Style LED Indicator Amber- 2000K
(W5W)	R501CBLED	12		W2.1 x 9.5d	10mm	151	Ring Premium LED Side & Tail - 6000K
(W5W)	R501DLED	12		W2.1 x 9.5d	10mm	151	Ring Performance LED Side & Tail - 7000K
(W5W)	R514	12	5	W2.1 x 9.5d	10mm	102	Miniature Halogen
(W5W)	R516	12	5	W2.1 x 9.5d	10mm	102	Miniature Halogen - Blue
WR5W	R501R	12	5	W2.1 x 9.5d	10mm	79	Side & Tail - Red
WY10W	R931	12	10	W2.1 x 9.5d	14mm	80	Indicator - Amber
WY16W	R958	12	16	W2.1 x 9.5d	16mm	83	Indicator - Amber
WY2.3W	R284A	12	2.3	W2 x 4.6d	5mm	108	Indicator - Amber
WY21W	R585	12	21	W3 x 16d	20.5mm	85	Indicator - Amber
WY5W	R501A	12	5	W2.1 x 9.5d	10mm	78	Indicator - Amber

Vehicle Lighting

PART NO.	VOLTS	WATTS	ECE	CAP	SIZE	DIAGRAM	DESCRIPTION
R002	12	36		BA15s SCC	38mm	55	Headlamp
R005	12	36		BA15d SBC	38mm	54	Headlamp
R012	12	60/55	H4	P45t H4 UEC	17mm	4	Halogen Headlamp
R023	12	48		BA15s SCC	38mm	55	Headlamp
R024	24	75/70	(H4)	P45t H4 UEC	17mm	4	Halogen Headlamp
R027	12	48		BA15d SBC	38mm	54	Headlamp
R1003	12	15CP		BA15s (SCC)	25mm	63	Caravan & Interior
R1005	12	60	HB3	P20d	12mm	6	Ring XenonMax Halogen Headlamp
R1006	12	51	HB4	P22d	12mm	8	Ring XenonMax Halogen Headlamp
R1011	12	55	H11	PGJ19-2	11.6mm	16	Ring XenonMax Halogen Headlamp
R1030	14	0.9 (65mA)		W2 x 4.6d	5mm	108	Panel
R1048	12	55	H1	P14.5s	10mm	1	Ring XenonMax Halogen Headlamp
R1053	12	55	H3	PK22s	11.5mm	3	Ring XenonMax Halogen Headlamp
R1072	12	60/55	H4	P43t	17mm	5	Ring XenonMax Halogen Headlamp
R1077	12	55	H7	PX26d	11.6mm	10	Ring XenonMax Halogen Headlamp
R110	12	50		E27-ES	60mm	169	Inspection Lamp Bulb
R112	12	24		SCC	38mm	168	Inspection Lamp Bulb
R1184P	24	22		B22d LBC	38mm	160	Bus Interior- Pearl
R12085	12	19	PS19W	PG20-1	16mm	91	HiPervision Brake/Indicator/Reverse/Rear Fog
R12086	12	24	PS24W	PG20-3	16mm	92	HiPervision Brake/Indicator/Reverse/Rear Fog
R12182	12	24	PW24W	WP3.3x14.5-3		93	HiPervision Brake/Indicator/Reverse/Rear Fog
R12188	12	24	PSY24W	PG20-4	16mm	92	HiPervision Indicator - Amber
R12190	12	24	PY24W	PGU20-4	16mm	92	HiPervision Indicator - Amber
R12274	12	24	PY24W	PGU20-4	16mm	92	HiPervision Indicator - Silver Amber
R12274HTR	12	24	PY24W	WP3.3X14.5-4	18mm	93	HiPervision Indicator - Amber
R12275	12	19	PSY19W	PG20-2	16mm	91	HiPervision Indicator - Amber
R12276	12	24	PSX24W	PG20-7	16mm	92	HiPervision Brake/Indicator/Reverse/Rear Fog
R12277	12	13	P13W	PG18.5d-1	20mm	90	HiPervision Day Time Running
R12278	12	26	PSX26W	PG18.5d-3	18mm	95	HiPervision Brake/Indicator/Reverse/Rear Fog
R123	24	36		BA15d SBC	38mm	54	Headlamp
R12410	12/24	25	D5S	PK32d-7C1		34	Gas Discharge Headlamp
R1401	12	5	W5W	W2.1 x 9.5d	10mm	77	Ring Xenon4400 Side & Tail
R143	24	2.8		BA9s (MCC)		75	Panel/Interior
R1471	24	1.2 (40mA)		BAX EBSR	5mm	123	Panel - Brown Base
R149	24	5	R5W	BA15s (SCC)	16mm	71	Side & Tail
R1493FSLED	24		(R5W)	BA15s (SCC)	18mm	149	Ring Filament Style LED Side & Tail - 3000K
R1496LED	24		(R5W)	BA15s (SCC)	18mm	149	Ring Premium LED Side & Tail - 6000K
R150	24	5	R5W	BA15d (SBC)	18mm	73	Side & Tail
R1506LED	24		(R5W)	BA15d (SBC)	18mm	149	Ring Premium LED Side & Tail - 6000K
R1511	12	55	H11	PGJ19-2	11.6mm	16	Ring Xenon150 Halogen Headlamp
R1548	12	55	H1	P14.5s	10mm	1	Ring Xenon150 Halogen Headlamp
R1572	12	60/55	H4	P43t	17mm	5	Ring Xenon150 Halogen Headlamp
R1577	12	55	H7	PX26d	11.6mm	10	Ring Xenon150 Halogen Headlamp
R1590	48	5		BA9s (MCC)	Tub.9mm	75	Side & Tail
R1791	24	1.2 (53mA)		BAX EBSR	5mm	123	Panel - Yellow Base
R1791LED	24	1.2		BAX EBSR	5mm	158	Panel - Yellow Base
R180	12	21/7	P27/7W	W2.5 x 16q	25.5mm	88	Brake & Tail
R182	12	27	P27W	W2.5 x 16d	25.5mm	87	Brake/Indicator/Reverse/Rear Fog
R183	12	27/7	PY27/7W	WX2.5 x 16q	25.5mm	89	HiPervision Indicator - Amber
R184	12	27		W2.5x16d	25.5mm	87	Indicator - Amber
R185	12	48		P36s	28mm	57	Headlamp
R205	6	5	R5W	BA15s (SCC)	16mm	71	Side & Tail
R206	6	5	R5W	BA15d (SBC)	18mm	73	Side & Tail
R207	12	5	R5W	BA15s (SCC)	16mm	71	Side & Tail
R2073FSLED	12		(R5W)	BA15s (SCC)	18mm	149	Ring Filament Style LED Side & Tail - 3000K
R207B	12	5		BA15s (SCC)	18mm	71	Interior - Blue
R207LED	12		(R5W)	BA15s (SCC)	18mm	149	Ring Premium LED Side & Tail - 6000K
R207LL	12	5	R5W	BA15s (SCC)	16mm	71	Long Life Side & Tail
R207RR	12	5	R5W	BA15s (SCC)	16mm	71	Rapid Response Side & Tail
R209	12	5	R5W	BA15d (SBC)	16mm	73	Side & Tail
R210	12	10		BA15d (SBC)	16mm	73	Side & Tail
R227	24	5		BA9s (MCC)	15mm	76	Side & Tail
R233	12	4	T4W	BA9s (MCC)	9mm	75	Side & Tail
R2336FSLED	12		(T4W)	BA9s	10mm	154	Ring Filament Style LED Side & Tail - 3000K

PART NO.	VOLTS	WATTS	ECE	CAP	SIZE	DIAGRAM	DESCRIPTION
R233B	12	4		BA9s (MCC)	Tub.9mm	75	Interior - Blue
R233LL	12	4	T4W	BA9s (MCC)	9mm	75	Long Life Side & Tail
R237	12	7		S8.5d	10 x 40mm	96	Festoon
R239	12	5	C5W	S8.5d	11 x 38mm	96	Festoon
R23912LED	12		(C5W)	S8.5d	11 x 38mm	153	Ring Standard LED Festoon - 12000K
R2396LED	12		(C5W)	S8.5d	11 x 38mm	153	Ring Standard LED Festoon - 6000K
R239CBLED	12		(C5W)	S8.5d	11 x 38mm	153	Ring Premium LED Festoon - 6000K
R239CBLED	24		(C5W)	S8.5d	11 x 38mm	153	Ring Premium LED Festoon - 6000K
R239FSLED	12		(C5W)	S8.5d	11 x 38mm	153	Ring Filament Style LED Festoon - 6000K
R239LL	12	5	C5W	S8.5d	11 x 38mm	96	Long Life Festoon
R240	12	15		BA15s (SCC)	25mm	63	Side & Tail
R2401LED	24	20mA		Bi-Pin	3mm	157	Panel - LED Black Base
R241	24	21	P21W	BA15s (SCC)	25mm	63	Brake/Indicator/Reverse/Rear Fog
R2413FSLED	24		(P21W)	BA15s (SCC)	25mm	146	Ring Filament Style LED Brake/Indicator/Reverse/Rear Fog 3000K
R2416LED	24		(P21W)	BA15s (SCC)	25mm	146	Ring Premium LED Brake/Indicator/Reverse/Rear Fog 6000K
R242	24	5	C5W	S8.5d	11 x 38mm	96	Festoon
R2426FSLED	24		(C5W)	S8.5d	11 x 38mm	153	Ring Filament Style LED Festoon - 6000K
R242G	24	5		S8.5d	11 x 38mm	96	Festoon - Green
R243	24	15		BA15s (SCC)	25mm	63	Side & Tail
R244	6	10	R10W	BA15s (SCC)	16mm	71	Side & Tail
R245	12	10	R10W	BA15s (SCC)	16mm	71	Side & Tail
R2453FSLED	12		(R10W)	BA15s (SCC)	18mm	149	Ring Filament Style LED Side & Tail - 3000K
R245B	12	10		BA15s (SCC)	16mm	71	Side & Tail - Blue
R245LL	12	10	R10W	BA15s (SCC)	16mm	71	Long Life Side & Tail
R245RR	12	10	R10W	BA15s (SCC)	16mm	71	Rapid Response Side & Tail
R246	24	10	R10W	BA15s (SCC)	16mm	71	Side & Tail
R2463FSLED	24		(R10W)	BA15s (SCC)	18mm	149	Ring Filament Style LED Side & Tail - 3000K
R247	24	5	R5W	BA15d (SBC)	16mm	73	Heavy Duty Side & Tail
R248	24	5	R5W	BA15s (SCC)	16mm	71	Heavy Duty Side & Tail
R249	24	4	T4W	BA9s (MCC)	9mm	75	Side & Tail
R2496LED	24		(T4W)	BA9s	10mm	154	Ring Premium LED Side & Tail - 6000K
R249G	24	4		BA9s (MCC)	9mm	75	Interior - Green
R253	6	5	C5W	S8.5d	11 x 38mm	96	Festoon
R254	12	6		S8.5d	11 x 38mm	96	Festoon
R256	12	3		S7d	8 x 38mm	98	Festoon
R258	12	5		S8.5d	11 x 42mm	96	Festoon
R260	24	5		S8.5d	11 x 42mm	96	Festoon
R261	12	5		S7d	8 x 26mm	98	Festoon
R263	12	3		S7d	8 x 31mm	98	Festoon
R264	12	10		S8.5d	11 x 44mm	96	Festoon
R265	12	10		S8.5d	15 x 44mm	97	Festoon
R266	6	15		S8.5d	15 x 44mm	97	Festoon
R267	12	15		S8.5d	15 x 44mm	97	Festoon
R268	12	3		S6d	6 x 36mm	98	Festoon
R269	12	10		S8.5d	11 x 30mm	96	Festoon
R270	12	18		S8.5d	15 x 44mm	97	Festoon
R271	24	3		S6d	7 x 30mm	98	Festoon
R272	12	10		S8.5d	11 x 38mm	96	Festoon
R273	12	21	C21W	S8.5d	15 x 44mm	97	Festoon
R274	24	10		S8.5d	11 x 41mm	96	Festoon
R275	24	21		S8.5d	15 x 44mm	97	Festoon
R276	24	18		S8.5d	15 x 44mm	97	Festoon
R280	12	1.5		E5/8	7mm	112	Panel
R281	12	2		BA7s	7mm	116	Panel
R282	6	1.2		BA7s	7mm	116	Panel
R283	24	3		BA7s	7mm	116	Panel
R284	12	2.3	W2.3W	W2 x 4.6d	5mm	108	Panel
R284A	12	2.3	WY2.3W	W2 x 4.6d	5mm	108	Indicator - Amber
R285	24	1		E5/8	7mm	112	Panel
R286	12	1.2		W2 x 4.6d	5mm	108	Panel
R286A	12	1.2		W2 x 4.6d	5mm	108	Panel - Amber
R286B	12	1.2		W2 x 4.6d	5mm	108	Panel - Blue
R286G	12	1.2		W2 x 4.6d	5mm	108	Panel - Green
R286R	12	1.2		W2 x 4.6d	5mm	108	Panel - Red

Vehicle Lighting

PART NO.	VOLTS	WATTS	ECE	CAP	SIZE	DIAGRAM	DESCRIPTION
R287	6	2		BA9s MCC	9mm	117	Panel
R288	12	2		BA9s MCC	9mm	117	Panel
R289	24	2		BA9s MCC	9mm	117	Panel
R290	24	21	P21W	BA15s (SCC)	25mm	63	Heavy Duty Brake/Indicator/Reverse/Rear Fog
R291	24	21	P21W	BA15d (SBC)	25mm	66	Heavy Duty Brake/Indicator/Reverse/Rear Fog
R293	6	4	T4W	BA9s (MCC)	9mm	75	Side & Tail
R294	24	21/5	P21/5W	BAY15d (OSP)	25mm	68	Brake/Tail
R2943FSLED	24		(W5W)	W2.1 x 9.5d	10mm	151	Ring Filament Style LED Side & Tail - 6000K
R2946FSLED	24		(P21/5W)	BAY15d (OSP)	25mm	148	Ring Performance LED Brake/Tail - 3000K
R295	24	10	R10W	BA15s (SCC)	16mm	71	Heavy Duty Side & Tail
R296	24	4	T4W	BA9s (MCC)	9mm	75	Heavy Duty Side & Tail
R297	12	2.2		W2.1 x 9.5d	10mm	77	Panel
R298	24	2.2		W2.1 x 9.5d	10mm	77	Panel
R3005	12	60	HB3	P20d	12mm	6	Ring IceBlue Halogen Headlamp
R312	6	30/24		P36d	28mm	60	Headlamp
R317	6	21	P21W	BA15s (SCC)	25mm	63	Brake/Indicator/Reverse/Rear Fog
R319	6	21	P21W	BA15d (SBC)	25mm	66	Brake/Indicator/Reverse/Rear Fog
R32/3	12	32/4 CP		BAY15d (OSP)	25mm	68	Daylight Running
R323	12	48		P36d	28mm	59	Headlamp
R326	12	38		P36d	28mm	58	Headlamp
R330	24	44		P36d	28mm	58	Headlamp
R3306	12	51	HB4	P22d	12mm	8	Ring Xenon130 Halogen Headlamp
R331	24	44		P36d	28mm	61	Headlamp
R3311	12	55	H11	PGJ19-2	11.6mm	16	Ring Xenon130 Halogen Headlamp
R333	24	24		BA15d (SBC)	25mm	66	Brake/Indicator/Reverse/Rear Fog
R334	24	24/6		BAY15d (OSP)	25mm	68	Brake/Tail
R3343	12	21		BA15s (SCC)	25mm	63	Indicator - Silver Amber
R3348	12	55	H1	P14.5s	10mm	1	Ring Xenon130 Halogen Headlamp
R335	12	21	P21W	BA15d (SBC)	25mm	66	Brake/Indicator/Reverse/Rear Fog
R3372	12	60/55	H4	P43t	17mm	5	Ring Xenon130 Halogen Headlamp
R3377	12	55	H7	PX26d	11.6mm	10	Ring Xenon130 Halogen Headlamp
R3381	12	21		BAU15s (OSP)	25mm	64	Indicator - Silver Amber
R339	24	24		BA15s (SCC)	25mm	63	Brake/Indicator/Reverse/Rear Fog
R343	12	21		BA15s (SCC)	25mm	63	Indicator - Amber
R344	28	26		BA15d (SBC)	25mm	66	Brake/Indicator/Reverse/Rear Fog
R345	28	26		BA15s (SCC)	25mm	63	Brake/Indicator/Reverse/Rear Fog
R346	24	21	P21W	BA15d (SBC)	25mm	66	Brake/Indicator/Reverse/Rear Fog
R347	24	21		BA15s (SCC)	25mm	63	Indicator - Amber
R3501A	12	5		W2.1 x 9.5d	10mm	78	Indicator - Silver Amber
R3581	12	21	PY21W	BAU15s (OSP)	25mm	64	Indicator - Silver Amber
R3603	12	25/25		PX15D	19mm	39	Motorcycle Headlamp
R3625	6	25/25		PX15D	19mm	39	Motorcycle Headlamp
R3780	12	21/5	PR21/5W	BAW15d	25mm	69	Brake/Tail - Silver Red
R3782	12	21	PR21W	BAW15s	25mm	65	Brake-Silver Red
R380	12	21/5	P21/5W	BAY15d (OSP)	25mm	68	Brake/Tail
R3803FSLED	12		(P21/5W)	BAY15d (OSP)	25mm	148	Ring Filament Style LED Brake/Tail - 3000K
R380DLED	12		(P21/5W)	BAY15d (OSP)	25mm	148	Ring Performance LED Brake/Tail - 7000K
R380HD	12	21/5	P21/5W	BAY15d (OSP)	25mm	68	Heavy Duty Brake/Tail
R380LED	12		(P21/5W)	BAY15d (OSP)	25mm	148	Ring Premium LED Brake/Tail - 6000K
R380LL	12	21/5	P21/5W	BAY15d (OSP)	25mm	68	Long Life Brake/Tail
R380R	12	21/5		BAY15d (OSP)	25mm	68	Brake & Tail - Red
R380RR	12	21/5	P21/5W	BAY15d (OSP)	25mm	68	Rapid Response Brake/Tail
R381	12	21/5		BA15d (SBC)	25mm	67	Brake/Tail
R382	12	21	P21W	BA15s (SCC)	25mm	63	Brake/Indicator/Reverse/Rear Fog
R3823FSLED	12		(P21W)	BA15s (SCC)	25mm	146	Ring Filament Style LED Brake/Indicator/Reverse/Rear Fog 3000K
R382DLED	12		(P21W)	BA15s (SCC)	25mm	146	Ring Performance LED Brake/Indicator/Reverse/Rear Fog 7000K
R382HD	12	21	P21W	BA15s (SCC)	25mm	63	Heavy Duty Brake/Indicator/Reverse/Rear Fog
R382LED	12		(P21W)	BA15s (SCC)	25mm	146	Ring Premium LED Brake/Indicator/Reverse/Rear Fog 6000K
R382LL	12	21	P21W	BA15s (SCC)	25mm	63	Long Life Brake/Indicator/Reverse/Rear Fog
R382R	12	21		BA15s (SCC)	25mm	63	Brake - Red
R382RR	12	21	P21W	BA15s (SCC)	25mm	63	Rapid Response Brake/Indicator/Reverse/Rear Fog
R383	6	21/5		BA15d (SBC)	25mm	67	Brake/Tail
R384	6	21/5	P21/5W	BAY15d (OSP)	25mm	68	Brake/Tail
R385	12	18		BA15s (SCC)	25mm	63	Side & Tail

PART NO.	VOLTS	WATTS	ECE	CAP	SIZE	DIAGRAM	DESCRIPTION
R388	28	1.2 (40mA)		Midget groove	6mm	114	Panel
R392	6	25/25	S1	BA20d Bosch	35mm	56	Headlamp
R393	6	35/35	S2	BA20d Bosch	35mm	56	Headlamp
R394	12	25/25	S1	BA20d Bosch	35mm	56	Headlamp
R395	12	35/35	S2	BA20d Bosch	35mm	56	Headlamp
R396	12	45/40		BA20d Bosch	35mm	56	Headlamp
R398	24	45/40		BA20d Bosch	35mm	56	Headlamp
R4011	12	55	H11	PGJ19-2	11.6mm	16	Ring Xenon4000 Halogen Headlamp
R4072	12	60/55	H4	P43t	17mm	5	Ring Xenon4000 Halogen Headlamp
R4077	12	55	H7	PX26d	11.6mm	10	Ring Xenon4000 Halogen Headlamp
R410	12	45/40	R2	P45t	40mm	53	Headlamp
R412	12	20		P26S	10mm	38	Headlamp
R414	12	50/40		P36d	28mm	62	Headlamp
R416	12	60/60		P45t ASY UEC	40mm	53	Headlamp
R417	12	35/35	S2	BA20d Bosch	14mm	42	Halogen Headlamp
R418	12	23		BA9s (MCC)	9mm	99	Miniature Halogen - Amber
R4187	48	10		BA15s (SCC)	16mm	71	Side & Tail
R419	12	23		BA9s (MCC)	9mm	99	Miniature Halogen Brake/Indicator/Reverse/Rear Fog
R4190	48	8		BAY15d (OSP)	18mm	74	Side & Tail
R4192	48	10		BAY15d (OSP)	18mm	74	Side & Tail
R423	6	45/40	R2	P45t	40mm	53	Headlamp
R42302	42	35	D3S	PK32d-5	9mm	30	Gas Discharge Headlamp
R423025K	42	35	D3S	PK32d-5	9mm	30	Gas Discharge Headlamp - 5500K +20%
R42306	42	35	D3R	PK32d-6	9mm	31	Gas Discharge Headlamp
R42402	42	35	D4S	P32d-5	9mm	32	Gas Discharge Headlamp
R424025K	42	35	D4S	P32d-5	9mm	32	Gas Discharge Headlamp - 5500K +20%
R42406	42	35	D4R	P32d-6	9mm	33	Gas Discharge Headlamp
R429	24	55/50	R2	P45t	40mm	53	Headlamp
R433	12	20		BA9s (MCC)	9mm	99	Miniature Halogen Brake/Indicator/Reverse/Rear Fog
R434	12	6	H6W	BAX9s	9mm	100	Miniature Halogen
R435	12	21	H21W	BAY9s	9mm	103	Miniature Halogen Brake/Indicator/Reverse/Rear Fog
R436	24	12		BA15d (SBC)	25mm	66	Bus Interior
R437	24	54/44		P36d	28mm	62	Headlamp
R441	36	45	(H3)	PK22s	11.5mm	3	Halogen Accessory Lamp
R442	48	45	(H3)	PK22s	11.5mm	3	Halogen Accessory Lamp
R443	80	55	(H3)	PK22s	11.5mm	3	Halogen Accessory Lamp
R444	24	50	(H3)	PK22s	11.5mm	3	Halogen Accessory Lamp
R4448	12	55	H1	P14.5s	10mm	1	Ring Xenon4400 Halogen Headlamp
R445	12	10	(H3)	PK22s	11.5mm	3	Halogen Accessory Lamp
R446	12	20	PK22s	(H3)	11.5mm	3	Halogen Accessory Lamp
R447	12	55	H3C	PK22s	11.5mm	52	Halogen Accessory Lamp
R4472	12	60/55	H4	P43t	17mm	5	Ring Xenon4400 Halogen Headlamp
R4477	12	55	H7	PX26d	11.6mm	10	Ring Xenon4400 Halogen Headlamp
R448	12	55	H1	P14.5s	10mm	1	Halogen Headlamp
R448EQ	12	55	H1A	P14.5s	10mm	1	EQ Halogen Headlamp
R448HD	12	55	H1	P14.5s	10mm	1	Heavy Duty Halogen Headlamp
R448LL	12	55	H1	P14.5s	10mm	1	Long Life Halogen Headlamp
R449	24	35	(H3)	PK22s	11.5mm	3	Halogen Accessory Lamp
R453	12	55	H3	PK22s	11.5mm	3	Halogen Accessory Lamp
R453LL	12	55	H3	PK22s	11.5mm	3	Long Life Halogen Accessory Lamp
R454	24	100	(H7)	PX26d	11.6mm	10	High Wattage Halogen Headlamp
R455	6	55	H3	PK22s	11.5mm	3	Halogen Accessory Lamp
R456	6	15	(H3)	PK22s	11.5mm	3	Halogen Accessory Lamp
R457	6	25	(H3)	PK22s	11.5mm	3	Halogen Accessory Lamp
R458	24	70	H11	PGJ19-2	11.6mm	16	Halogen Headlamp
R458HD	24	70	H11	PGJ19-2	11.6mm	16	Heavy Duty Halogen Headlamp
R459	12	35/35	HS1	PX43t	17mm	5	Halogen Headlamp
R4597	48	25		BAY15d (OSP)	25mm	68	Brake/Indicator/Reverse/Rear Fog
R4598	48	25		BA15s (SCC)	25mm	63	Brake/Indicator/Reverse/Rear Fog
R460	24	70	H3	PK22s	11.5mm	3	Halogen Accessory Lamp
R460HD	24	70	H3	PK22s	11.5mm	3	Heavy Duty Halogen Accessory Lamp
R461	24	65	(H3)	PK22s	11.5mm	3	Halogen Accessory Lamp
R462	12	35	(H3)	PK22s	11.5mm	3	Halogen Accessory Lamp
R463	12	60/55		P36t	17mm	47	Halogen Headlamp

Vehicle Lighting

PART NO.	VOLTS	WATTS	ECE	CAP	SIZE	DIAGRAM	DESCRIPTION
R464	12	100	(H7)	PX26d	11.6mm	10	Ring Rally Sport High Wattage Halogen Headlamp
R465	6	55	H1	P14.5s	10mm	1	Halogen Headlamp
R466	24	70	H1	P14.5s	10mm	1	Halogen Headlamp
R466HD	24	70	H1	P14.5s	10mm	1	Heavy Duty Halogen Headlamp
R467	12	5		BA15s (SCC)	9mm	106	Miniature Halogen Caravan & Interior
R468	12	10		BA15s (SCC)	9mm	106	Miniature Halogen Caravan & Interior
R469	12	5		BA9s (MCC)	9mm	99	Miniature Halogen Caravan & Interior
R4690	48	45		BA15s (SCC)	25mm	63	Brake/Indicator/Reverse/Rear Fog
R470	12	10		BA9s (MCC)	9mm	99	Miniature Halogen Caravan & Interior
R471	12	10		BA15d (SBC)	9mm	105	Miniature Halogen Caravan & Interior
R472	12	60/55	H4	P43t	17mm	5	Halogen Headlamp
R472EL	12	60/55	H4	P43t	17mm	5	Extra Life Halogen Headlamp
R472EQ	12	60/55	H4	P43t	17mm	5	EQ Halogen Headlamp
R472HD	12	60/55	H4	P43t	17mm	5	Heavy Duty Halogen Headlamp
R472LL	12	60/55	H4	P43t	17mm	5	Long Life Halogen Headlamp
R473	12	100/55	(H4)	P43t	17mm	5	Ring Rally Sport High Wattage Halogen Headlamp
R474	24	70	H7	PX26d	11.6mm	10	Halogen Headlamp
R474HD	24	70	H7	PX26d	11.6mm	10	Heavy Duty Halogen Headlamp
R475	24	75/70	H4	P43t	17mm	5	Halogen Headlamp
R475HD	24	75/70	H4	P43t	17mm	5	Heavy Duty Halogen Headlamp
R477	12	55	H7	PX26d	11.6mm	10	Halogen Headlamp
R477EL	12	55	H7	PX26d	11.6mm	10	Extra Life Halogen Headlamp
R477EQ	12	55	H7	PX26d	11.6mm	10	EQ Halogen Headlamp
R477FLED	12		(H7)	PX26d	18mm	144	Ring Premium LED Fog Light
R477LL	12	55	H7	PX26d	11.6mm	10	Long Life Halogen Headlamp
R479	12	55	(H2)	X511	9mm	2	Halogen Accessory Lamp
R480	12	100	(H2)	X511	9mm	2	Ring Rally Sport High Wattage Halogen Accessory Lamp
R481	12	100	(H1)	P14.5s	10mm	1	Ring Rally Sport High Wattage Halogen Headlamp
R482	24	70	(H2)	X511	9mm	2	High Wattage Halogen Accessory Lamp
R483	12	100	(H3)	PK22s	11.5mm	3	Ring Rally Sport High Wattage Halogen Accessory Lamp
R484	12	100/80	(H4)	P43t	17mm	5	Ring Rally Sport High Wattage Halogen Headlamp
R485	12	100/80	H4	P45t	17mm	4	Ring Rally Sport High Wattage Halogen Headlamp
R4896	48	25/10		BAY15d (OSP)	25mm	68	Brake & Tail
R490	12	130/90	(H4)	P43t	17mm	5	Ring RallySport High Wattage Halogen Headlamp
R491	12	130	(H2)	X511	9mm	2	Ring Rally Sport High Wattage Halogen Accessory Lamp
R492	12	130	(H3)	PK22s	11.5mm	3	Ring Rally Sport High Wattage Halogen Accessory Lamp
R493	24	100	(H1)	P14.5s	10mm	1	High Wattage Halogen Headlamp
R494	24	100	(H2)	X511	9mm	2	Ring Rally Sport High Wattage Halogen Accessory Lamp
R495	24	100	(H3)	PK22s	11.5mm	3	Ring Rally Sport High Wattage Halogen Accessory Lamp
R496	24	100/80	H4	P43t	17mm	5	Ring Rally Sport High Wattage Halogen Headlamp
R497	24	100/80	H4	P45t	17mm	4	Ring Rally Sport High Wattage Halogen Headlamp
R498	24	130/90	H4	P43t	17mm	5	Ring Rally Sport High Wattage Halogen Headlamp
R499	12	130	(H1)	P14.5s	10mm	1	Ring Rally Sport High Wattage Halogen Headlamp
R501	12	5	W5W	W2.1 x 9.5d	10mm	77	Side & Tail/Panel/Interior
R5011	12	55	H11	PGJ19-2	11.6mm	16	Ring Xenon5000 Halogen Headlamp
R50112LED	12		(W5W)	W2.1 x 9.5d	10mm	151	Ring Standard LED Side & Tail - 12000K
R5016FSLED	12		(W5W)	W2.1 x 9.5d	10mm	151	Ring Filament Style LED Side & Tail - 6000K
R5016LED	12		(W5W)	W2.1 x 9.5d	10mm	151	Ring Standard LED Side & Tail - 6000K
R501A	12	5	WY5W	W2.1 x 9.5d	10mm	78	Indicator - Amber
R501AFSLED	12		(W5W)	W2.1 x 9.5d	10mm	152	Ring Filament Style LED Indicator Amber- 2000K
R501B	12	5		W2.1 x 9.5d	10mm	77	Interior - Blue
R501CBLED	12		(W5W)	W2.1 x 9.5d	10mm	151	Ring Premium LED Side & Tail - 6000K
R501DLED	12		(W5W)	W2.1 x 9.5d	10mm	151	Ring Performance LED Side & Tail - 7000K
R501HD	12	5	W5W	W2.1 x 9.5d	10mm	77	Heavy Duty Side & Tail
R501LL	12	5	W5W	W2.1 x 9.5d	10mm	77	Long Life Side & Tail
R501R	12	5	WR5W	W2.1 x 9.5d	10mm	79	Side & Tail - Red
R501RR	12	5	W5W	W2.1 x 9.5d	10mm	77	Rapid Response Side & Tail
R504	12	3	W3W	W2.1 x 9.5d	10mm	77	Side & Tail/Panel/Interior
R5048	12	55	H1	P14.5s	10mm	1	Ring Xenon5000 Halogen Headlamp
R505	24	3	W3W	W2.1 x 9.5d	10mm	77	Side & Tail/Panel/Interior
R506	12	6		W2.1 x 9.5d	10mm	77	Side & Tail / Interior
R507	24	5	W5W	W2.1 x 9.5d	10mm	77	Side & Tail/Panel/Interior
R5072	12	60/55	H4	P43t	17mm	5	Ring Xenon5000 Halogen Headlamp
R5077	12	55	H7	PX26d	11.6mm	10	Ring Xenon5000 Halogen Headlamp

PART NO.	VOLTS	WATTS	ECE	CAP	SIZE	DIAGRAM	DESCRIPTION
R507B	24	5		W2.1 x 9.5d	10mm	77	Panel/Interior - Blue
R508	24	1.2		W2 x 4.6d	5mm	108	Panel
R508A	24	1.2		W2 x 4.6d	5mm	108	Panel - Amber Base
R508B	24	1.2		W2 x 4.6d	5mm	108	Panel - Blue Base
R508G	24	1.2		W2 x 4.6d	5mm	108	Panel - Green Base
R508R	24	1.2		W2 x 4.6d	5mm	108	Panel - Red Base
R508T	24	1.2		B8.5D	5mm	119	Panel - Grey Base
R508TBGY	24	1.2		B8.3D	5mm	122	Panel - Grey Base
R508TBR	24	1.2		BX8.5D	5mm	119	Panel - Brown Base
R508TCTR	24	1.2		KW2 x 4.6D	5mm	128	Panel - Transparent Base
R508TCWH	24	1.2		KW2 x 4.6D	5mm	128	Panel - White Base
R508TD	24	1		KW2 x 4.6D	5mm	128	Panel - White Base
R508TLED	24	1.2		BX8.5D	5mm	155	LED Panel - Grey Base
R508TMGR	24	1.4		B8.4D	5mm	118	Panel - Light Green Base
R508TMRE	24	1.5		BX8.4D	5mm	118	Panel - Red Base
R508TUWH	24	2.4		B9	5mm	130	Panel - White Base
R508TVWH	24	1.4		B29	5mm	131	Panel - White Base
R508TWBR	24	1.2		B8.7D	5mm	120	Panel - Brown Base
R509T	12	1.2		B8.5D	5mm	119	Panel - Black Base
R509TBBK	12	1.2		B8.3D	5mm	122	Panel - Black Base
R509TBE	12	1.5		B8.5D	5mm	119	Panel - Beige Base
R509TBL	12	1.2		BX8.5D	5mm	119	Panel - L Blue Base
R509TBWH	12	2		B8.3D	5mm	122	Panel - White Base
R509TCGY	12	0.5		KW2 x 4.6D	5mm	128	Panel - Grey Base
R509TCGY/1.8	12	1.8		KW2 x 4.6D	5mm	128	Panel - Grey Base
R509TCGYFR	12	0.5		KW2 x 4.6D	5mm	128	Panel - Grey Base - Frosted
R509TCTR	12	1.2		KW2 x 4.6D	5mm	128	Panel - Transparent Base
R509TCWH	12	1.2		KW2 x 4.6D	5mm	128	Panel - White Base
R509TDBK	12	1.2		T-1/4NW	5mm	126	Panel - Black Base
R509TEBK	12	1.2		BX2D	5mm	125	Panel - Black Base
R509TFBK/12	12	1.2		F4.8	5mm	121	Panel - Black Base
R509TFBK/14	14	1.4		F4.8	5mm	121	Panel - Black Base
R509TFGY	12	1.8		F4.8	5mm	121	Panel - Grey Base
R509TGR	12	2		B8.5D	5mm	119	Panel - Green Base
R509THGY	14	1.2 (60mA)		T-1.1/2TW	5mm	127	Panel - Grey Base
R509TJBR	14	1.2 (65mA)		T3	3mm	132	Panel - Brown Base
R509TKBK	12	1.2		B8.5 S/40	5mm	133	Panel - Black Base
R509TLBK	12	1.2		BG8.5-5.5D	5mm	134	Panel - Black Base
R509TMBE	12	1.5		BX8.4D	5mm	118	Panel - Beige Base
R509TMBK	12	1.2		BX8.4D	5mm	118	Panel - Black Base
R509TMLB	12	1.2		B8.4D	5mm	118	Panel - Blue Base
R509TMGR	12	2		BX8.4D	5mm	118	Panel - Green Base
R509TMGY	12	0.5		BX8.4D	5mm	118	Panel - Grey Base
R509TMOR	12	1.12		BX8.4D	5mm	118	Panel - Orange Base
R509TOR	12	1		BX8.5D	5mm	119	Panel - Orange Base
R509TPBK	12	1.2		SG8-5.5D	5mm	135	Panel - Black Base
R509TQWH	14	1.2 (65mA)		T3	3mm	136	Panel - White Base
R509TSBK	14	1CP		B11D	7mm	137	Panel - Black Base
R509TVI	12	0.4		BX8.5D	7mm	119	Panel -Violet Base
R509TWBR	12	1.2		B8.7D	5mm	120	Panel - Brown Base
R509TWGR	12	2		B8.7D	5mm	120	Panel - Green Base
R509TWGY	12	1.2		B8.7D	5mm	120	Panel - Grey Base
R509TYBK	14	1.4		T5	5mm	138	Panel - Black Base
R512PCB	12	2CP		P.C.B.	9mm	142	Panel - White Base
R512TR	12	2CP		B12.3D	9mm	143	Panel - White Base
R512WB	12	2		KW 2.1 x 9.5D	10mm	139	Panel - White Base
R513BWH	24	1.5		BA9d	13mm	129	Panel - White Base
R514	12	5	(W5W)	W2.1 x 9.5d	10mm	102	Miniature Halogen
R516	12	5	(W5W)	W2.1x9.5d	10mm	102	Miniature Halogen - Blue
R535	24	21	H21W	BAY9s	9mm	103	Miniature Halogen Brake/Indicator/Reverse/Rear Fog
R566	12	21/4	P21/4W	BAZ15d	25mm	70	Fog/Tail
R567	24	21/4	P21/4W	BAZ15d	25mm	70	Fog/Tail
R569	12	5		G4	9mm	107	Miniature Halogen Halogen Accessory Lamp
R570	12	10		G4	9mm	107	Miniature Halogen Halogen Accessory Lamp

Vehicle Lighting

PART NO.	VOLTS	WATTS	ECE	CAP	SIZE	DIAGRAM	DESCRIPTION
R571	24	20		G4	9mm	107	Miniature Halogen Halogen Accessory Lamp
R573	12	20		G4	9mm	107	Miniature Halogen Halogen Accessory Lamp
R574	24	10		G4	9mm	107	Miniature Halogen Halogen Accessory Lamp
R576	24	LED		LED Dichroic	51mm	163	LED Dichroic
R580	12	21/5	W21/5W	W3 x 16q	20.5mm	86	Brake/Tail
R581	12	21	PY21W	BAU15s (OSP)	25mm	64	Indicator - Amber
R581AFSLED	12		(PY21W)	BAU15s (OSP)	25mm	147	Ring Filament Style LED Indicator Amber- 2000K
R581HD	12	21	PY21W	BAU15s (OSP)	25mm	64	Heavy Duty Indicator - Amber
R581LL	12	21	PY21W	BAU15s (OSP)	25mm	64	Long Life Indicator - Amber
R582	12	21	W21W	W3 x 16d	20.5mm	84	Brake/Indicator/Reverse/Rear Fog
R585	12	21	WY21W	W3 x 16d	20.5mm	85	Indicator - Amber
R586	12	21		BAU15s (OSP)	25mm	64	Brake/Indicator/Reverse/Rear Fog
R588	24	21	PY21W	BAU15s (OSP)	25mm	64	Indicator - Amber
R589	12	10	RY10W	BA15s (SCC)	18mm	72	Indicator - Amber
R589AFSLED	12		(RY10W)	BAU15s (OSP)	18mm	150	Ring Filament Style LED Indicator Amber- 2000K
R590	12	160/100	(H4)	P43t	17mm	5	Ring Rally Sport High Wattage Halogen Headlamp
R591	12	130/90	H4	P45t	17mm	4	Ring Rally Sport High Wattage Halogen Headlamp
R601	12	5		W2.1 x 9.5d	10mm	77	Sportz Blue Side & Tail/ Interior
R606	24	44		P36s	28mm	59	Headlamp
R609	6	15	S3	P26s	25mm	37	Headlamp
R610	12	15	S3	P26s	25mm	37	Headlamp
R613	12	20		P26s	25mm	37	Headlamp
R621	24	36		BA15s SCC	38mm	55	Headlamp
R623	24	48		BA15s SCC	38mm	55	Headlamp
R641	6	3		BA9s MCC	11mm	115	Panel
R64122	12	3		B10D	8.8mm	124	Halogen Panel - Brown Base
R64124	12	5		B10D	8.8mm	124	Halogen Panel - Black Base
R643	12	2.2		BA9s MCC	11mm	115	Panel
R650	24	2.8		E10/13 MES	11mm	110	Panel
R651	24	2.8		BA9s MCC	15mm	113	Panel
R653	24	6		S8.5d	11 x 38mm	96	Festoon
R664	12	80	(H7)	PX26d	11.6mm	10	Ring SportzBlue Headlamp
R66548	40	25	D8S	PK32d-1		35	Gas Discharge Headlamp
R668	12	80	(H1)	P14.5s	10mm	1	Ring SportzBlue Headlamp
R684	12	100/80	(H4)	P43t	17mm	5	Ring SportzBlue Headlamp
R687	24	1.2		E5/8 LES Tub.	7mm	112	Panel
R692	24	24/6		BA15d (SBC)	25mm	67	Brake/Tail
R6929	24	1.2		BAX EBSR	5mm	123	Panel - Light Green Base
R695	24	2.8		E10/13 MES Tub.	9mm	112	Panel
R7027	12	35/35		P15D-3	30mm	40	Motorcycle Headlamp
R7028	12	45/40		P15D-3	30mm	40	Motorcycle Headlamp
R708	12	35	H8	PGJ19-1	11.6mm	11	Halogen Headlamp
R709	12	65	H9	PGJ19-5	11.6mm	13	Halogen Headlamp
R710	12	42	H10	PY20d	16mm	15	Halogen Headlamp
R711	12	55	H11	PGJ19-2	11.6mm	16	Halogen Headlamp
R711FLED	12		(H11)	PGJ19-2	18mm	145	Ring Premium LED Fog Light
R711LL	12	55	H11	PGJ19-2	11.6mm	16	Long Life Halogen Headlamp
R712	12	53	H12	PZ20d	16mm	18	Halogen Headlamp
R715	12	55/15	H15	PGJ26t-1	22mm	20	Halogen Headlamp
R716	12	19	H16	PGJ19-3	11.6mm	21	Halogen Headlamp
R718	12	55	H18	PY26d	15mm	22	Halogen Headlamp
R719	12	60/55	H19	PU43t-3	22mm	23	Halogen Headlamp
R740	12	20		BA15s (SCC)	9mm	106	Miniature Halogen Interior
R741	24	20		BA15s (SCC)	9mm	106	Miniature Halogen Interior
R780	12	21/5	PR21/5W	BAW15d	25mm	69	Brake & Tail - Red
R782	12	21	PR21W	BAW15s	25mm	65	Brake - Red
R795	12	50		BA15s (SCC)	9mm	106	Miniature Halogen Interior
R796	12	35		BA15s (SCC)	9mm	106	Miniature Halogen Interior
R8004	12	65/45	(HB1)	P29t	14.7mm	48	Ring XenonPlus Halogen Headlamp
R8005	12	60	HB3	P20d	12mm	6	Ring XenonPlus Halogen Headlamp
R8006	12	51	HB4	P22d	12mm	8	Ring XenonPlus Halogen Headlamp
R8007	12	65/55	(HB5)	PX29t	14.7mm	48	Ring XenonPlus Halogen Headlamp
R801	12	5	W5W	W2.1 x 9.5d	10mm	77	Ring IceBlue Side & Tail/ Interior
R804	12	12		B22d LBC	38mm	160	Bus Interior

PART NO.	VOLTS	WATTS	ECE	CAP	SIZE	DIAGRAM	DESCRIPTION
R805	12	12		BA15d SBC	38mm	159	Bus Interior
R809	12	24		B22d LBC	38mm	160	Bus Interior
R810	12	24		BA15d SBC	38mm	159	Bus Interior
R816	24	12		B22d LBC	38mm	160	Bus Interior
R817	24	12		BA15d SBC	38mm	159	Bus Interior
R821	24	20		B22d LBC	38mm	160	Bus Interior
R822	24	20		BA15d SBC	38mm	159	Bus Interior
R8328	24	1.2		EBSN10	5mm	140	Panel - Beige Base
R833	12	4	T4W	BA9s (MCC)	Tub.9mm	75	Ring IceBlue Side & Tail
R834	12	6	H6W	BAX9s	9mm	100	Ring IceBlue Side & Tail
R848	12	55	H1	P14.5s	10mm	1	Ring XenonPlus Halogen Headlamp
R85122	85	35	D2S	P32d-2	9mm	28	Gas Discharge Headlamp
R85122100	85	35	D2S	P32d-2	9mm	28	Gas Discharge Headlamp +100%
R851225K	85	35	D2S	P32d-2	9mm	28	Gas Discharge Headlamp - 5500K +20%
R851265	85	35	D2R	P32d-3	9mm	29	Gas Discharge Headlamp
R851265K	85	35	D2R	P32d-3	9mm	29	Gas Discharge Headlamp - 5500K +20%
R85402	85	35	D1S	PK32d-2	9mm	26	Gas Discharge Headlamp
R85402100	85	35	D1S	PK32d-2	9mm	26	Gas Discharge Headlamp - 5500K +20%
R854025K	85	35	D1S	PK32d-2	9mm	26	Gas Discharge Headlamp - 5500K +20%
R85406	85	35	D1R	PK32d-3	9mm	27	Gas Discharge Headlamp
R86021001	12	1.2		BAX EBSR	5mm	123	Panel - Green Base
R86021002	12	1.8		BAX EBSR	5mm	123	Panel - Blue Base
R86021003	24	1.2		EBS-N	5mm	140	Panel - Yellow Base
R86024918	24	1.2		BAX10D	5mm	140	Panel - Grey Base
R86028166	24	2.4		BAX10D	5mm	140	Panel - Yellow Base
R862	12	5		E10/13 MES	15mm	109	Panel
R864/14	14	0.5		E5/8 LES	Tub.7mm	112	Panel
R865	24	2.8		BA9s MCC	11mm	115	Panel
R872	12	60/55	H4	P43t	17mm	5	Ring XenonPlus Halogen Headlamp
R874	28	7		BA15s (SCC)	16mm	71	Side & Tail
R875	28	7		BA15d (SBC)	16mm	73	Side & Tail
R877	12	55	H7	PX26d	11.6mm	10	Ring XenonPlus Halogen Headlamp
R880	12	27	H27W/1	PG13	9mm	43	Halogen Headlamp
R88005996	12.6	1.5			5mm	141	Panel - White Base
R881	12	27	H27W/2	PGJ13	9mm	44	Halogen Headlamp
R882	12	21	W21W	W3 x 16d	20.5mm	84	Xenon4000 Brake/Indicator/Reverse/Rear Fog
R883	12	21/5	W21/5W	W3 x 16q	20.5mm	86	Xenon4000 Brake/Tail
R885	12	50		PG13	9mm	45	Halogen Headlamp
R886	12	50		PGJ13	9mm	46	Halogen Headlamp
R887	12	50		PG13	9mm	45	Long Life Halogen Headlamp
R894	12	37.5		PGJ13	9mm	46	Halogen Headlamp
R9003	12	60/55	HB2	P43t	17mm	5	Halogen Headlamp
R9004	12	65/45	(HB1)	P29t	14.7mm	48	Halogen Headlamp
R9005	12	60	HB3	P20d	12mm	6	Halogen Headlamp
R9005XS	12	60	HB3A	P20d	12mm	7	Halogen Headlamp
R9006	12	51	HB4	P22d	12mm	8	Halogen Headlamp
R9006XS	12	51	HB4A	P22d	12mm	9	Halogen Headlamp
R9007	12	65/55	(HB5)	PX29t	33.8mm	48	Halogen Headlamp
R9008	12	60/55	H13	P26.4t	16mm	19	Halogen Headlamp
R901	6	35/35		BA20d Bosch	35mm	42	Halogen Headlamp
R9011	12	65	HIR1	PX20d	20mm	24	Halogen Headlamp
R9012	12	55	HIR2	PX22d	20mm	25	Halogen Headlamp
R904	12	45/40	R2	P45t	17mm	4	Halogen Headlamp
R905	6	60/55	H4	P43t H4	17mm	5	Halogen Headlamp
R906	12	21		BA15s (SCC)	25mm	106	Miniature Halogen
R907	12	15	S3	P26s	25mm	38	Headlamp
R908	24	3		S7d	8 x 36mm	98	Festoon
R909	12	21		BA15s (SCC)	16mm	71	Side & Tail
R910	6	35/35	HS1	PX43t	17mm	5	Halogen Headlamp
R911	12	45/40	H4	P43t	17mm	5	Halogen Headlamp
R913	6	25/25		P15D-25-3	30mm	41	Motorcycle Headlamp
R914	6	35/35		P15D-25-3	30mm	41	Motorcycle Headlamp
R916	12	25		E14	15mm	111	Panel
R917	12	15		E14	15mm	111	Panel

Vehicle Lighting

PART NO.	VOLTS	WATTS	ECE	CAP	SIZE	DIAGRAM	DESCRIPTION
R919	12	65	H9B	PGJY19-5	15mm	14	Halogen Headlamp
R920	12	35	H8B	PGJY19-1	15mm	12	Halogen Headlamp
R921	12	21CP		W2.1 x 9.5d	16mm	82	Brake (High Level Brake Light)
R921A	12	21CP		W2.1 x 9.5d	16mm	83	Indicator - Amber
R922	12	10		W2.1 x 9.5d	14mm	80	Inspection Lamp Bulb
R923	24	10		W2.1 x 9.5d	14mm	80	Side & Tail/Panel/Interior
R924	12	55	H11B	PGJY19-2	22.5mm	17	Halogen Headlamp
R925	12	16	PC16WY	PU20d-2	20mm	90	Hipervision Indicator - Amber
R926	12	6	HY6W	BAZ9s	9mm	101	Miniature Halogen - Amber
R927	12	21	HY21W	BAW9s	9mm	104	Miniature Halogen - Amber
R928	12	24	P24W	PU20-3	18mm	94	HiPervision Brake/Indicator/Reverse/Rear Fog
R929	12	35/30	HS5	P23t	25mm	36	Motorcycle Headlamp
R930	12	10	W10W	W2.1 x 9.5d	14mm	80	Side & Tail/Panel/Interior
R931	12	10	WY10W	W2.1 x 9.5d	14mm	80	Indicator - Amber
R948	12	55	H1	P14.5s	10mm	1	Ring UltraXenon Halogen Headlamp
R950	6	6		E10/13 MES	15mm	109	Panel
R951	6	5		BA9s (MCC)	15mm	76	Side & Tail
R955	12	16	W16W	W2.1 x 9.5d	16mm	82	Brake/Indicator/Reverse/Rear Fog
R958	12	16	WY16W	W2.1 x 9.5d	16mm	83	Indicator - Amber
R960	12	55(85)	H3C	P22d/5	12mm	52	Halogen Headlamp Import - 556
R961	12	55	H3r	PK22sr	12mm	50	Halogen Headlamp Import - 453
R962	12	55/40		P30t-40	14mm	51	Halogen Headlamp Import - 488
R963	12	65/55		P30/22L	16mm	49	Halogen Headlamp Import - 507
R964	12	45/55		P30/22L	16mm	49	Halogen Headlamp Import - 471
R965	12	65/65		P30/22L	16mm	49	Halogen Headlamp Import - 472
R972	12	60/55	H4	P43t	17mm	5	Ring UltraXenon Halogen Headlamp
R977	12	55	H7	PX26d	11.6mm	10	Ring UltraXenon Halogen Headlamp
R981	6	3		E10/13 MES	15mm	110	Panel
R982	6	1.8		E10/13 MES	11mm	110	Panel
R987	12	2.2		E10/13 MES	11mm	110	Panel
R989	12	5		BA9s (MCC)	15mm	76	Panel/Side & Tail
R990	6	3		E10/13 MES	11mm	110	Panel
R9905	12	60	HB3	P20d	12mm	6	Ring UltraXenon Halogen Headlamp
R9906	12	51	HB4	P22d	12mm	8	Ring UltraXenon Halogen Headlamp
R992	12	10		BA9s (MCC)	15mm	76	Side & Tail
R993	24	2.8		E10/13 MES	15mm	109	Panel
RIL200	12/230	11		-	-	170	Compact Fluorescent
RTM149	24	5	R5W	BA15s (SCC)	16mm	71	TruckMaster Side & Tail
RTM149HDLL	24	5	R5W	BA15s (SCC)	16mm	71	TruckMaster Heavy Duty Long Life Side & Tail
RTM150	24	5	R5W	BA15d (SBC)	16mm	73	TruckMaster Side & Tail
RTM150HDLL	24	5	R5W	BA15d (SBC)	16mm	73	TruckMaster Heavy Duty Long Life Side & Tail
RTM241	24	21	P21W	BA15s (SCC)	25mm	63	TruckMaster Brake/Indicator/Reverse/Rear Fog
RTM241HDLL	24	21	P21W	BA15s (SCC)	25mm	63	TruckMaster Heavy Duty Long Life Brake/Indicator/Reverse/Rear Fog
RTM242	24	5	C5W	S8.5d	11 x 38mm	96	TruckMaster Festoon
RTM246	24	10	R10W	BA15s (SCC)	18mm	71	TruckMaster Side & Tail
RTM246HDLL	24	10	R10W	BA15s (SCC)	18mm	71	TruckMaster Heavy Duty Long Life Side & Tail
RTM249	24	4	T4W	BA9s (MCC)	Tub.9mm	75	TruckMaster Side & Tail
RTM249HDLL	24	4	T4W	BA9s (MCC)	Tub.9mm	75	TruckMaster Heavy Duty Long Life Side & Tail
RTM274	24	10		S8.5d Standard	11 x 41mm	96	TruckMaster Festoon
RTM283	24	3		BA7s Peanut	Tub.7mm	116	TruckMaster Panel
RTM289	24	2		BA9s MCC	Tub.9mm	117	TruckMaster Panel
RTM294	24	21/5	P21/5W	BAY15d (OSP)	25mm	68	TruckMaster Brake/Tail
RTM346	24	21	P21W	BA15d (SBC)	25mm	66	TruckMaster Brake/Indicator/Reverse/Rear Fog
RTM346HDLL	24	21	P21W	BA15d (SBC)	25mm	66	TruckMaster Heavy Duty Long Life Brake/Indicator/Reverse/Rear Fog
RTM458HDLL	24	70	H11	PGJ19-2	11.6mm	16	TruckMaster Heavy Duty Long Life Halogen Headlamp
RTM460	24	70	H3	PK22s	11.5mm	3	TruckMaster Halogen Accessory Lamp
RTM460HDLL	24	70	H3	PK22s	11.5mm	3	TruckMaster Heavy Duty & Long Life Halogen Accessory Lamp
RTM466	24	70	H1	P14.5s	10mm	1	TruckMaster Halogen Headlamp
RTM466HDLL	24	70	H1	P14.5s	10mm	1	TruckMaster Heavy Duty Long Life Halogen Headlamp
RTM474	24	70	H7	PX26d	11.6mm	10	TruckMaster Halogen Headlamp
RTM474HDLL	24	70	H7	PX26d	11.6mm	10	TruckMaster Heavy Duty Long Life Halogen Headlamp
RTM475	24	75/70	H4	P43t	17mm	5	TruckMaster Halogen Headlamp
RTM475HDLL	24	75/70	H4	P43t	17mm	5	TruckMaster Heavy Duty Long Life Halogen Headlamp
RTM505	24	3	W3W	W2.1 x 9.5d	10mm	77	TruckMaster Side & Tail /Panel/ Interior



PART NO.	VOLTS	WATTS	ECE	CAP	SIZE	DIAGRAM	DESCRIPTION
RTM507	24	5	W5W	W2.1 x 9.5d	10mm	77	TruckMaster Side & Tail /Panel/ Interior
RTM508	24	1.2		W2 x 4.6d	5mm	108	TruckMaster Panel
RTM508T	24	1.2		B8.5D	5mm	119	TruckMaster Panel - Grey Base
RTM535	24	21	H21W	BAY9s	9mm	103	Truckmaster Miniature Halogen Brake/Indicator/Reverse/Rear Fog
RTM588	24	21	PY21W	BAU15s (OSP)	25mm	64	TruckMaster Indicator - Amber
RTM588HDLL	24	21	PY21W	BAU15s (OSP)	25mm	64	TruckMaster Heavy Duty Long Life Indicator - Amber
RTM865	24	2.8		BA9s MCC	11mm	115	TruckMaster Panel
74199	230	120		RS7	118mm	167	Linear Halogen
74200	230	230		RS7	118mm	167	Linear Halogen
74201	230	400		RS7	118mm	167	Linear Halogen
121030XB	12	10		MR11	34mm	162	Halogen Interior - 30° Angle
61003B		13		T5	21"	165	21" White Fluorescent Tube
61008B		8		T5	1ft	165	1ft White Fluorescent Tube
61010C		36		T8	4ft	166	4ft White Fluorescent Tube
61011C		58		T8	5ft	166	5ft White Fluorescent Tube
61012B		15		T8	18"	166	18" White Fluorescent Tube
61014B		30		T8	3ft	166	3ft White Fluorescent Tube
64005B		18		T8	2t	166	2ft White Fluorescent Tube
74214P	230	25		G9	13mm	164	Halogen Interior
74220B	12	10		MR16/Dichroic	51mm	163	Halogen Interior - 38° Angle
A1001-R		8		T5	1ft	165	1ft Warm White Fluorescent Tube
A1002-R		8		T5	1ft	165	1ft Warm White Fluorescent Tube
A1003-R		15		T8	18"	166	18" White Fluorescent Tube
A1016-R		30		T8	3ft	166	3ft Warm White Fluorescent Tube
A1019		18		T8	2t	166	2ft Daylight Fluorescent Tube
A1020		18		T8	2t	166	2ft Cool White Deluxe Fluorescent Tube
A1021		36		T8	4ft	166	4ft Cool White Deluxe Fluorescent Tube
A1023		58		T8	5ft	166	5ft Cool White Deluxe Fluorescent Tube
A1038-R		18		T8	2t	166	2ft White Deluxe Fluorescent Tube
A1038-X		13		T5	21"	165	21" White Fluorescent Tube
A1047		15/33		T8	18"	166	18" Cool White Fluorescent Tube
A1049		30		T8	3ft	166	3ft Daylight Fluorescent Tube
A1050		36		T8	3ft	166	3ft Cool White Fluorescent Tube
A1051		36		T8	4ft	166	4ft White Deluxe Fluorescent Tube
A1053		58		T8	5ft	166	5ft White Fluorescent Tube
A1054		28		T5	4ft	165	4ft Cool White Fluorescent Tube
A1056		6		T5	9"	165	9 inch White Fluorescent Tube
A122030	12	20		MR11	34mm	162	Halogen Interior - 30° Angle
A123530	12	35		MR11	34mm	162	Halogen Interior - 30° Angle
A241012	24	10		MR16/Dichroic	51mm	163	Halogen Interior - 12° Angle
A242038	24	20		MR16/Dichroic	51mm	163	Halogen Interior - 38° Angle
A242060	24	20		MR16/Dichroic	51mm	163	Halogen Interior - 60° Angle
A243538	24	35		MR16/Dichroic	51mm	163	Halogen Interior - 38° Angle
A3003		4		T5	6"	165	6 inch White Fluorescent Tube
A61009		70		T8	6ft	166	6ft White Deluxe Fluorescent Tube
DLM69E	12	20		MR16	51mm	161	Halogen Interior - 36° Angle
LED286B	12		(W2.3W)	B8.5d	5mm	156	Ring Standard LED - Blue
LED509TB	12			B8.5d	5mm	155	Ring Standard LED - Blue
TH50011	110	500		RS7	118mm	167	Linear Halogen

Vehicle Lighting

Ring	Philips
R465	6258
R455	6336
R319	6402
R317	6498
R384	6499
R383	6503
R423	6620
R392	6718
R244	6814
R205	6821
R206	6822
R282	6829
R253	6844
R990	6875
R641	6910
R293	6929
R393	7008
R9004	9004
R9007	9007
R9008	9008
R9012	9012
R710	9145
R610	12008
R469	12023
R470	12024
R433	12025
R434	12036
R501RR	12040
R506	12040
R880	12059
R881	12060
R284	12061
R582	12065
R580	12066
R955	12067
R585	12071
R12085	12085
R12086	12086
R782	12088
R237	12144
R927	12146
R005	12221
R002	12222
R504	12256
R12276	12276
R12277	12277
R12278	12278
R479	12311
R453	12336
R435	12356
R708	12360
R709	12361
R716	12366
R240	12401
R12410	12410
R335	12442
R385	12445
R012	12475
R904	12475
R780	12495
R581	12496
R382	12498
R380	12499
R381	12503
R286	12516
R715	12580
R566	12594
R509TBBK	12597
R509T	12598
R509TGR	12600
R509TBL	12603

Ring	Philips
R509TWGR	12604
R64122	12614
R64124	12615
R410	12620
R509TML	12623
R509TMOR	12624
R509TMBK	12625
R509TMGR	12626
R509TMBE	12627
R459	12636
R509TBE	12637
R509TVI	12640
R394	12718
R395	12728
R414	12741
R396	12748
R273	12803
R270	12807
R245	12814
R207	12821
R209	12822
R281	12829
R256	12843
R239	12844
R268	12848
R267	12850
R272	12854
R269	12860
R258	12864
R264	12866
R987	12875
R643	12910
R288	12913
R280	12926
R233	12929
R297	12960
R501	12961
R501HD	12961
R623	13241
R123	13242
R505	13256
RTM505	13256
R466	13258
RTM466	13258
R331	13293
R482	13311
R460	13336
R475	13342
RTM475	13342
R243	13401
R588	13496
R241	13498
R294	13499
RTM294	13499
R508	13516
RTM508	13516
R508TBY	13597
R508T	13598
RTM508T	13598
R429	13620
R437	13741
R276	13807
R246	13814
R271	13818
R149	13821
R150	13822
RTM150	13822
R283	13829
R242	13844
R653	13844
R260	13864

Ring	Philips
R274	13866
RTM274	13866
R650	13875
R993	13875
R865	13910
R289	13913
R249	13929
R298	13960
R507	13961
RTM507	13961
R474	13972
R346	24004
RTM346	24004
R1791	24029
R508TBR	24032
R535	24356
RTM535	24356
R1471	24506
R86021003	24606
R85406	85409
R464	12035RA
R834	12036BV
R589	12093NA
R12182	12182HTR
R12188	12188NA
R12190	12190NA
R1401	12256BV
R448LL	12258LL/ 12258LLECO
R448	12258PR
R448EQ	12258PR
R848	12258PR
R948	12258VP/ 12258NGDL
R4448	12258WHV
R1048	12258XV
R3348	12258XV
R12274HTR	12274HTR
R12274	12274SV+
R12275	12275NA
R453LL	12336LL / 12336LLECO
R472HD	12342HD
R472LL	12342LL/ 12342LLECO
R472	12342PR
R472EL	12342PR
R472EQ	12342PR
R1572	12342RV
R5072	12342RV
R872	12342VP/ 13242NGDL
R4472	12342WHV
R3372	12342XV
R711LL	12362LL/ 12362LLECO
R711	12362PR
R4011	12362WHV
R501A	12396NA
R668	12425RA
R481	12454RA
R483	12455RA
R581LL	12496LL
R581HD	12496LL/ 12496LLECO
R3581	12496SV
R382LL	12498LL/ 12498LLECO
R382RR	12498VP
R380LL	12499LL/ 12499LLECO

Ring	Philips
R380RR	12499VP
R480	12507RA
R484	12569RA
R473	12593RA
R485	12596RA
R245LL	12814LLECO
R207LL	12821LL/ 12821LLECO
R233LL	12929LL
R501LL	12961LL/ 12961LLECO
R477LL	12972LL/ 12972LLECO
R477	12972PR
R877	12972PR
R477EL	12972PR
R477EQ	12972PR
R1577	12972RV
R977	12972VP
R4477	12972WHV
R3377	12972XV
RTM466HDLL	13258ML
R460HD	13336MD
RTM460	13336MD
RTM460HDLL	13336ML
R475HD	13342MD
RTM475HDLL	13342ML
R972	13342VP
RTM588HDLL	13496ML
RTM588	13496ML
R290	13498MD
RTM241	13498MD
RTM241HDLL	13498ML
R495	13628RA
R295	13814MD
RTM246HDLL	13814ML
RTM246	13814ND
R248	13821MD
RTM149	13821MD
RTM149HDLL	13821ML
RTM249	13929MD
R296	13929MD
RTM249HDLL	13929ML
RTM474	13972MD
R474HD	13972MD
RTM474HDLL	13972ML
RTM346HDLL	24004HDLL
R458HD	24362MD
R458	24362MD
RTM458HDLL	24362ML
R496	24569RA
R42306	42306VI
R42402	42402VI
R424025K	42402XV2
R42302	42403VI
R423025K	42403WHV2
R42406	42406VI
R85122	85122VI
R851225K	85122WHV2
R85122100	85122XV2
R851265	85126VI
R851265K	85126WHV2
R85402	85415VI
R854025K	85415WHV2
R85402100	85415XV2
R3005	9005BV
R9005	9005PR
R8005	9005PR
R9006	9006PR
R8006	9006PR



Ring	Osram
R880	880
R881	881
R955	921
R32/3	1157
R12276	2504
R263	2628
R286	2721
R284	2723
R508	2741
R297	2820
R504	2821
R501	2825
R501A	2827
R298	2840
R505	2841
R507	2845
R182	3156
R180	3157
R987	3766
R288	3796
R289	3797
R282	3798
R989	3860
R293	3892
R233	3893
R643	3894
R287	3895
R281	3898
R283	3899
R249	3930
R990	3965
R650	3967
R244	5001
R205	5006
R207	5007
R245	5008
R589	5009
R12085	5201
R12086	5202
R206	5406
R209	5407
R150	5626
RTM150	5626
R149	5627
R246	5637
R295	5637
R865	6251
R319	6402
R264	6411
R258	6413
R253	6416
R239	6418
R908	6421
R242	6423
RTM242	6423
R260	6424
R268	6428
R274	6429
RTM274	6429
R271	6430
R269	6438
R272	6461
R270	6475
R273	6476
R267	6541
R312	6721
R641	6910
R393	7130
R566	7225
R381	7240
R392	7323
R395	7327
R396	7351
R185	7447
R323	7447
R005	7468
R317	7501
R585	7504
R582	7505
R382	7506
R581	7507
R588	7510
R241	7511
R580	7515
R384	7517
R380	7528
R243	7529
R294	7537
R383	7540

Ring	Osram
R623	7668
R423	7950
R429	7952
R276	8480
R9004	9004
R9005	9005
R9006	9006
R9007	9007
R9008	9008
R9011	9011
R9012	9012
R710	9145
R290	9511
R496	62248
R498	62249
R469	64111
R470	64113
R433	64115
R434	64132
R435	64136
R535	64138
RTM535	64138
R455	64147
R448	64150
R453	64151
R466	64155
RTM466	64155
R460	64156
RTM460	64156
R465	64168
R479	64173
R482	64175
R715	64176
R410	64183
R459	64185
R472	64193
R472EL	64193
R475	64196
R024	64199
R027	64199
R477	64210
R477EL	64210
R711	64211
R708	64212
R709	64213
R474	64215
R924	64241
R920	64242
R919	64243
R394	64326
R417	64327
R85402	66140
R85406	66150
R85122	66240
R851265	66250
R42302	66340
R42306	66350
R42402	66440
R42406	66450
R66548	66548
R472EQ	94193
R4477	64210CBI
R509TOR	2321MFX
R509TVI	2322MFX
R509TML	2351MF6
R509TMBK	2351MFX6
R509TMGR	2352MFX6
R509TMBE	2452MFX6
R509TMOR	2473MFX6
R207RR	2619NH
R509T	2721MF
R509TBBK	2721MF8
R509TWGR	2721MF8W
R509TBL	2721MFX
R509TGR	2722MF
R509TFBK/14	2722MF
R509TBWH	2722MF8
R509TWGY	2722MF8W
R508T	2741MF
RTM508T	2741MF
R508TBGY	2741MF8
R508TBR	2741MFX
R509TBE	2752MF
R801	2825CBI
R1401	2825HCBI
R516	2825HCBI
R501LL	2825ULT
RTM507	2845TSP
R506	2886X

Ring	Osram
R183	3757AK
R833	3893CB
RTM249	3930TSP
RTM249HDLL	3930TSP
R207LL	5007ULT
R245LL	5008ULT
RTM149	5627TSP
RTM149HDLL	5627TSP
RTM246HDLL	5637TSP
RTM246	5637TSP
R481	62200SBP
R483	62201SBP
R484	62204SBP
R664	62210CBB
R464	62261SBP
R64122	64122MF
R64124	64124MF
R927	64137ULT
R4448	64150CBI
R1048	64150NBS
R1548	64150NL
R448EQ	64150S
R948	64150SV2
R448LL	64150ULT
R1053	64151NBS
R499	64152SB
R492	64153SB
RTM466HDLL	64155TSP
R460HD	64156TSP
RTM460HDLL	64156TSP
R718	64180L
R719	64181L
R239LL	6418ULT
R4472	64193CBI
R1072	64193NBS / 64193NR1
R1572	64193NL
R5072	64193NL
R684	64193NR
R972	64193SV2 / 64193NR5
R472LL	64193ULT
R485	64194SB
RTM475	64196TSP
R475HD	64196TSP
RTM475HDLL	64196TSP
R012	64198SB
R490	64204SB
R1077	64210NBS / 64210NR1
R1577	64210NL
R977	64210SV2 / 64210NR5
R477LL	64210ULT
R877	64210XR
R4011	64211CBI
R1011	64211NBS / 64211NR1
R1511	64211NL
R711LL	64211ULT
RTM474	64215TSP
R474HD	64215TSP
RTM474HDLL	64215TSP
R458HD	64216TSP
RTM458HDLL	64216TSP
R716	64219L
R254	6486X
R854025K	66140CBI
R85402100	66140XNB
R851225K	66240CBI
R85122100	66240XNB
R851265K	66250CBI
R423025K	66340CBI
R424025K	66440CBI
R382LL	7506ULT
R3581	7507LDA
R581LL	7507ULT
R782	7508LDR
RTM588HDLL	7510TSP
RTM588	7510TSP
RTM241	7511TSP
RTM241HDLL	7511TSP
R380LL	7528ULT
RTM294	7537TSP
R780	7538LDR
R3782	7538LDR
R3780	7538LDR
R9003	9003L
R3005	9005CBI
R1005	9005NBU
R9005XS	9005XS
R1006	9006NBU
R9006XS	9006XS
R958	921NA

Vehicle Lighting

Ring	GE
R501	501
R504	504
R317	1053
R581	1056
R382	1057
R335	1058
R385	1059
R241	1060
RTM241	1060
R346	1061
RTM346	1061
R588	1073
RTM588	1073
R384	1076
R380	1077
R294	1078
R381	1098
R243	1115
R566	1122
R240	1143
R423	1926
R410	1931
R429	1937
R206	2614
R205	2615
R209	2618
R150	2626
RTM150	2626
R149	2627
RTM149	2627
R244	2639
R210	2640
R246	2643
RTM246	2643
R293	2659
R288	2660
R249	2661
RTM249	2661
R233	2662
R289	2663
R987	2683
R862	2683
R283	2692
R281	2696
R282	2960
R286	5301
R505	5305
R297	5313
R582	7440
R580	7443
R253	7544
R239	7546
R242	7552
RTM242	7552
R258	7575
R264	7576
R260	7579
R274	7580
RTM274	7580
R269	7585
R267	7592
R270	7593
R276	7595
R9004	9004
RTM475	50450
R498	52660
R490	52670
R904	52950
R85122	53500
R851265	53510
R85402	53620
R851265K	53770
R435	53990
R535	54400
R433	56110
R469	58540
R470	58560

Ring	GE
R467	58570
R468	58580
R392	91210
R393	91220
R395	91221
R396	91231
R398	91232
R508	91602
RTM508	91602
R284	91605
RTM505	91612
R507	91622
RTM507	91622
R1791	91693
R1471	91693
R263	91701
R271	91702
R272	91715
R273	91761
R581LL	1056LFD
R581HD	1056LFD
R343	1057L
R382LL	1057LFD
R382RR	1057NH
R290	1060HD
RTM241HDLL	1060HDL
R291	1061HD
RTM346HDLL	1061HDL
RTM588HDLL	1073HDNAL
R380LL	1077LFD
R380RR	1077NH
RTM294	1078HDL
R207	2619/2619T
R207LL	2619LFD
R207RR	2619NH
R247	2626HD
RTM150HDLL	2626HDL
R248	2627HD
RTM149HDLL	2627HDL
R245	2641/2641T
R245LL	2641LFD
R245RR	2641NH
R295	2643HD
RTM246HDLL	2643HDL
R296	2661HD
RTM249HDLL	2661HDL
R233LL	2662LFD
R501A	501A
R501RR	501NH
R448	50310/1U
R448LL	50310DPU
R948	50310MPU
R4448	50310SBU
R5048	50310SUP
R3348	50310XNU
R1048	50310XU
R466	50320/1U
RTM466	50320/1U
RTM466HDLL	50320/1U_HDL
R453LL	50340DPU
R453	50340U
R460	50350U
RTM460	50350U
R460HD	50350U_HDL
RTM460HDLL	50350U_HDL
R495	50400U
R479	50410U
R482	50420U
R472LL	50440DPU
R472	50440HU
R472EL	50440HU
R473	50440LU_DPU/52090U
R972	50440MPU
R1572	50440NXNU
R4472	50440SBU
R5072	50440SUP
R1072	50440SXU

Ring	GE
R3372	50440XNU
RTM475HDLL	50450HDLU
R475	50450U
R459	50470U
R485	52030U
R012	52070U
R024	52080U
R484	52100U
R483	52130U
R481	52140U
R480	52150U
R496	52710U
R497	52730U
R434	52830U
R509T	5301PS
R508T	5302PS
RTM508T	5302PS
R509TGR	5303PS
R9005	53060U
R3005	53060U
R1005	53060XU
R1006	53070SXU
R9006	53070U
R710	53080U
R708	53090HU
R709	53100U
R711	53110HU
R5011	53110SUP
R1011	53110SXU
R3311	53110XNU
R85122100	53500CMU
R85402100	53620CMU
R42302	53660U
R42402	53670U
R854025K	53750U
R851225K	53760U
R423025K	53780U
R424025K	53790U
R872	53800NHSU
R9012	54430U
R880	54480U
R881	54490U
R4477	5820SBU
R877	58320NHSU
R477LL	58520DPU
R711LL	58520LU_DPU
R977	58520MPU
R1577	58520NXNU
R5077	58520SUP
R1077	58520SXU
R477	58520U
R477EL	58520U
R477EQ	58520U
R3377	58520XNU
R474HD	58521HDLU
RTM474HDLL	58521HDLU
R458HD	58521HDLU
RTM458HDLL	58521HDLU
R474	58521U
RTM474	58521U
R585	7440NA
R239LL	7546LFD
R509TCGY	91609PS
R509TCGYFR	91609PS/91608PS
R801	91625 BLUE
R509TMBK	91641PS
R509TMGR	91645PS
R509TMBE	91646PS
R509TWBR	91651PS
R509TBWH	91665PS
R509TBBK	91671PS
R509TFBK/14	91695PS14V
R86021002	91696PS
R501LL	930LFD
R955	W16W
R958	WY16WNAL



Ring	Lucas
R002	LLB002
R005	LLB005
R012	LLB012
R024	LLB024
R447	LLB0452
R961	LLB0453
R446	LLB0456
R462	LLB0457
R964	LLB0471
R965	LLB0472
R962	LLB0488
R963	LLB0507
R3603	LLB1006
R913	LLB1008
R3625	LLB1010
R7027	LLB1011
R7028	LLB1012
R862	LLB1024
R914	LLB1039
R901	LLB1048
R417	LLB1052
R266	LLB1060
R418	LLB1064
R384	LLB1074
R123	LLB123
R149	LLB149
RTM149HDLL	LLB149LLP
R150	LLB150
R509TFBK/14	LLB1587
R180	LLB180
R183	LLB180A
R182	LLB182
R184	LLB182A
R925	LLB183a
R12277	LLB184
R185	LLB185
R12190	LLB186A
R12188	LLB187A
R12085	LLB188
R12276	LLB189
R9012	LLB190
R12275	LLB192
R205	LLB205
R206	LLB206
R207	LLB207S
R207B	LLB207T
R209	LLB209
R210	LLB210
R240	LLB211
R243	LLB212
R385	LLB213
R921A	LLB221A
R227	LLB227
R233	LLB233
R233LL	LLB233LL
R239	LLB239
R239LL	LLB239LL
R241	LLB241
R347	LLB241AMBER
RTM241HDLL	LLB241LLP / LLB290PR
R242	LLB242
R242G	LLB243GT
R244	LLB244
R589	LLB245A
R245LL	LLB245LL
R245	LLB245S
R246	LLB246
RTM246	LLB246HD
RTM246HDLL	LLB246LLP
RTM150	LLB247
R248	LLB248
R249	LLB249
RTM249	LLB249HD
RTM249HDLL	LLB249LLP
R253	LLB253
R254	LLB254
R256	LLB256
R271	LLB257
R258	LLB258
R260	LLB260
R261	LLB261
R263	LLB263
R264	LLB264
R265	LLB265
R267	LLB267

Ring	Lucas
R268	LLB268
R269	LLB269
R270	LLB270
R272	LLB272
R273	LLB273
R274	LLB274
R275	LLB275
R276	LLB275A/LLB276
R280	LLB280
R281	LLB281
R282	LLB282
R283	LLB283
R284	LLB284
R286	LLB286
R286A	LLB286A
R286B	LLB286B
R286G	LLB286G
R509TPBK	LLB286MFHZ
R509TKBK	LLB286MFSL
R509TMGY	LLB286PA
R509TCGY/1.8	LLB286PA
R509TCWH	LLB286PA
R509TCGYFR	LLB286PB
R286R	LLB286R
R509T	LLB286TAC
R509TEBK	LLB286TB1
R86021002	LLB286TBL
R509TFBK/12	LLB286TFB
R509TDBK	LLB286TFB1
R509TFGY	LLB286TFG
R509TWGY	LLB286TG
R509TMLB	LLB286THB
R509TMBE	LLB286THB
R509TMBK	LLB286THBL
R509TMGR	LLB286THLG
R509TMOR	LLB286THO
R509TGR	LLB286TLG
R509TOR	LLB286TO
R509TWGR	LLB286TV
R509TBBK	LLB286TVW
R509TBWH	LLB286TW
R287	LLB287
R288	LLB288
R289	LLB289
R290	LLB290
R291	LLB291
R293	LLB293
R294	LLB294
R609	LLB295
R295	LLB295
R297	LLB297
R610	LLB298
R317	LLB317
R319	LLB319
R323	LLB323
R326	LLB326
R330	LLB330
R331	LLB331
R333	LLB333
R334	LLB334
R335	LLB335
R339	LLB339
R343	LLB343
R344	LLB344
R345	LLB345
R346	LLB346
R436	LLB348
R380	LLB380
R32/3	LLB380D
R380LL	LLB380LL
R380R	LLB380R
R381	LLB381
R382	LLB382
R382LL	LLB382LL
R382R	LLB382R
R383	LLB383
R780	LLB383
R782	LLB385
R392	LLB392
R393	LLB393
R394	LLB394
R395	LLB395
R396	LLB396
R398	LLB398
R410	LLB410
R414	LLB414

Ring	Lucas
R416	LLB416
R4187	LLB4187
R4192	LLB4192
R423	LLB423
R429	LLB429
R433	LLB433
R470	LLB433A
R569	LLB433B
R434	LLB434
R535	LLB435
RTM535	LLB435
R435	LLB436
R437	LLB437
R442	LLB442
R444	LLB444
R448	LLB448
R448LL	LLB448LLP
R448EQ	LLB448P
R449	LLB449
R453	LLB453
R455	LLB455
R456	LLB456
R457	LLB457
R4597	LLB4597
R4598	LLB4598
R460	LLB460
R460HD	LLB460HD
R465	LLB465
R466	LLB466
RTM466HDLL	LLB466LL
R467	LLB467
R468	LLB468
R741	LLB469
R740	LLB470
R471	LLB471
R472	LLB472
R459	LLB472A
R472HD	LLB472HD
R472LL	LLB472LLP
R473	LLB473
R474	LLB475
RTM474HDLL	LLB475LL
R496	LLB475R
R498	LLB475R
R477	LLB477
R477EL	LLB477
R477LL	LLB477LLP
R479	LLB479
R482	LLB480
R481	LLB481
R480	LLB482
R483	LLB483
R484	LLB484
R485	LLB485
R590	LLB486
R499	LLB487
R491	LLB488
R492	LLB489
R4896	LLB4896
R490	LLB490
R493	LLB491
R494	LLB492
R495	LLB495
R497	LLB497
R501	LLB501
R501A	LLB501A
R501B	LLB501B
R501LL	LLB501LL
R504	LLB504
R505	LLB505
R507	LLB507
R508	LLB508
R508A	LLB508A
R508B	LLB508B
R508TUWH	LLB508B9
R86021003	LLB508EBSN1
R8328	LLB508EBSN10
R508G	LLB508G
R508TCWH	LLB508P
R508R	LLB508R
R508T	LLB508TAC
R1471	LLB508TB
R508TWBR	LLB508TBN
R508TBR	LLB508TBR
R508TMGR	LLB508TGN
R508TBY	LLB508TGY

Ring	Lucas
R1791	LLB508TY
R512PCB	LLB512
R512TR	LLB512TF10
R512WB	LLB512WP
R588	LLB558
RTM588HDLL	LLB558LLP
R566	LLB566
R567	LLB567
R580	LLB580
R581	LLB581
R581LL	LLB581LLPX2
R582	LLB582
R585	LLB582A
R586	LLB583
R621	LLB621
R641	LLB641
R643	LLB643
R650	LLB650
R651	LLB651
R653	LLB653
R687	LLB687
R695	LLB695
R64124	LLB700
R64122	LLB700A
R708	LLB708
R709	LLB709
R710	LLB710
R711	LLB711
R712	LLB712
R715	LLB715
R716	LLB716
R475	LLB775
R475HD	LLB775HD
RTM475HDLL	LLB775LL
R464	LLB784
R454	LLB785
R795	LLB795 / LLB1050
R796	LLB796
R804	LLB804
R805	LLB805
R809	LLB809
R810	LLB810
R816	LLB816
R817	LLB817
R821	LLB821
R822	LLB822
R865	LLB865
R874	LLB874
R875	LLB875
R880	LLB880
R881	LLB881
R886	LLB886
R9004	LLB9004
R9005	LLB9005
R9005XS	LLB9005XS
R9006	LLB9006
R9006XS	LLB9006XS
R9007	LLB9007
R9008	LLB9008
R921	LLB921
R951	LLB951
R955	LLB955
R987	LLB987
R989	LLB989
R990	LLB990 (2w)
R993	LLB993
R85406	LLBD1R
R85402	LLBD1S
R851265	LLBD2R
R85122	LLBD2S
R42306	LLBD3R
R42302	LLBD3S
R42406	LLBD4R
R42402	LLBD4S
R1077	LLX447XLU
R1048	LLX448XLU
R972	LLX472XLP
R1072	LLX472XLU
R977	LLX477XLP
R668	LLX481BL
R684	LLX484BL
R801	LLX501BL
R664	LLX784BL
R3005	LLX9005BL

Vehicle Lighting

Notes



Brightest for longest.



xenon150[®]

The brightest, longest lasting
+150% performance halogen bulb.

Up to 150% more light on the road, over 350 hours of night time driving, 80m longer beam of light and a 3700K whiter light output for a safer drive.*

*compared to a standard bulb





Ring Automotive Limited . Gelderd Road, Leeds, LS12 6NA United Kingdom
Telephone +44 (0)113 213 2000 . Fax +44 (0)113 231 0266

European Headquarters . 5, Rue de la Haye, Bât. Le Dôme, 5ème étage
93 290 Tremblay-en-France
Tél +33 (0)1 48 16 09 23 . Fax +33 (0)1 48 16 09 24

Email autosales@ringautomotive.com . www.ringautomotive.com

     /ringautomotive

In line with our policy of continuous product development, Ring Automotive Limited reserve the right to alter specification without notice. Whilst every care has been taken in compiling the information in this catalogue, Ring Automotive Limited cannot accept legal liability for any errors or omissions. Manufacturers' names and part numbers are for reference only. Illustrations are intended only to be representative of the parts offered, sizes quoted are nominal. © Copyright 2019 Ring Automotive Limited.

CAT1341

