



Bridgelux® GENg V8 Array Series

Product Data Sheet DS1306



Introduction

V Series



The V Series™ LED Array products deliver high quality light in a compact and cost-effective solid-state lighting package. These chip on board (CoB) arrays can be efficiently driven more than two times the nominal drive current, enabling design flexibility not previously possible. These high flux density light sources are designed to support a wide range of high quality, low cost directional luminaires and replacement lamps for both interior and exterior commercial and residential applications.

The Gen 9 V Series COB is a high efficacy product that uses narrow band red phosphor to significantly improve the spectrum efficacy. The improved spectrum efficacy results in the 80 CRI product of the Gen 9 Series delivering better or equivalent efficacy as that of our previous generation V Series product.

The V8 LED Array is available in a variety of electrical, CCT, and CRI combinations providing substantial design flexibility and energy efficiency advantages.

Lighting system designs incorporating these LED arrays deliver increased system level efficacy and a longer service life. Typical applications include replacement lamps and task, accent, spot, track, wide area, security, wall packs and down lights.

Features

- Efficacy of 191 lm/W typical, 3000K 80 CRI
- Wide selection of CCT options (2700K-5000K) with minimum 80 CRI options
- Uniform high-quality illumination
- 2 and 3 SDCM binning options (2700K – 4000K)
- 3 and 4 SDCM binning options (5000K)
- Forward voltage bin codes and backside marking
- Instant light with unlimited dimming
- 5-Year warranty

Benefits

- Enables high efficiency lighting systems and lower operating costs
- Supports the trend toward luminaire miniaturization and delivers enhanced optical control
- Design flexibility for a broad range of lighting applications
- Clean white light without pixelation
- Uniform consistent white light
- Design flexibility for multi-source applications
- Easy to use with daylight and motion sensors to increase energy savings
- Design with confidence

Contents

Product Feature Map	2
Product Nomenclature	2
Product Selection Guide	3
European Product Registry for Energy Labeling	5
Performance at Commonly Used Drive Currents	6
Electrical Characteristics	8
Eye Safety	9
Absolute Maximum Ratings	10
Performance Curves	11
Typical Radiation Pattern	13
Typical Color Spectrum	14
Mechanical Dimensions	15
Color Binning Information	16
Packaging and Labeling	17
Design Resources	19
Precautions	19
Disclaimers	19
About Bridgelux	20

Product Feature Map

Bridgelux arrays are fully engineered devices that provide consistent thermal and optical performance on an engineered mechanical platform. The V Series arrays are the most compact CoB devices across all of Bridgelux's LED Array products.

The arrays incorporate several features to simplify design integration and assembly. Please visit www.bridgelux.com for more information on the V Series family of products.

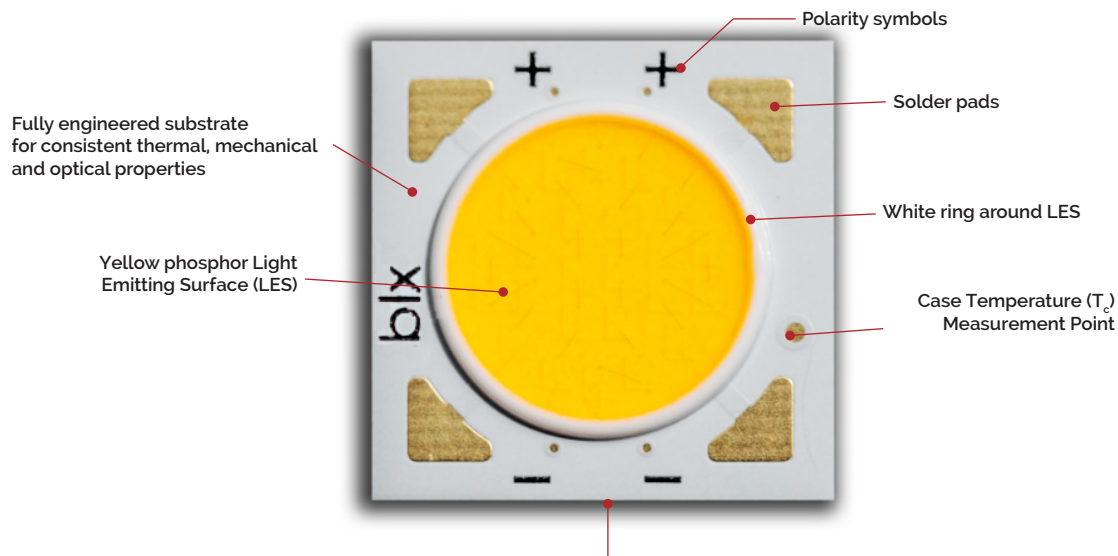

Note: Part number and lot codes are scribed on back of array

Product Nomenclature

The part number designation for Bridgelux V Series LED arrays is explained as follows:

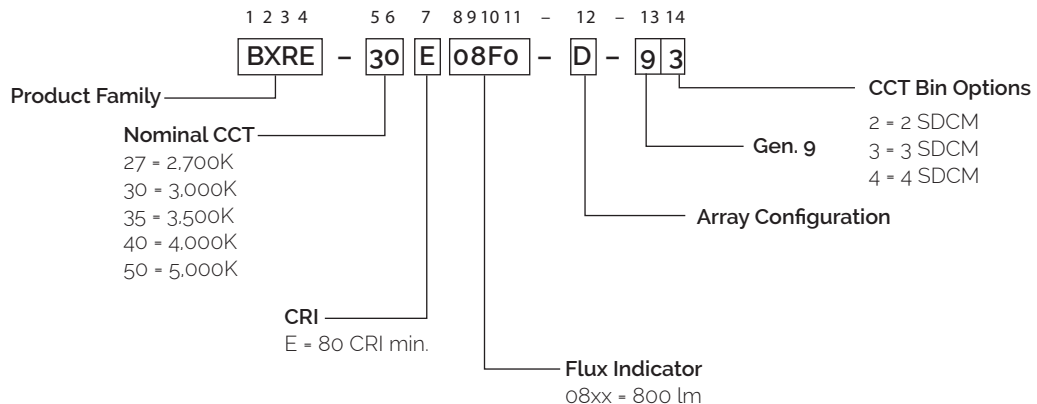

Product Selection Guide

The following product configurations are available:

Table 1: Selection Guide, Pulsed Measurement Data ($T_j = T_c = 25^\circ\text{C}$)

Part Number	Nominal CCT ¹ (K)	CRI ²	Nominal Drive Current ³ (mA)	Typical Pulsed Flux ^{4,5,6} $T_c = 25^\circ\text{C}$ (lm)	Minimum Pulsed Flux ^{6,7} $T_c = 25^\circ\text{C}$ (lm)	Typical V_f (V)	Typical Power (W)	Typical Efficacy (lm/W)
BXRE-27E08F0-D-gx	2700	80	300	951	856	16.9	5.1	187
BXRE-27E08F0-E-gx	2700	80	150	951	856	33.9	5.1	187
BXRE-30E08F0-D-gx	3000	80	300	970	873	16.9	5.1	191
BXRE-30E08F0-E-gx	3000	80	150	970	873	33.9	5.1	191
BXRE-35E08F0-D-gx	3500	80	300	975	877	16.9	5.1	192
BXRE-35E08F0-E-gx	3500	80	150	975	877	33.9	5.1	192
BXRE-40E08F0-D-gx	4000	80	300	980	882	16.9	5.1	193
BXRE-40E08F0-E-gx	4000	80	150	980	882	33.9	5.1	193
BXRE-50E08F0-D-gx	5000	80	300	960	864	16.9	5.1	189
BXRE-50E08F0-E-gx	5000	80	150	960	864	33.9	5.1	189

Notes for Table 1:

1. Nominal CCT as defined by ANSI C78.377-2011.
2. CRI values are minimums and tested at $T_j = T_c = 85^\circ\text{C}$. Minimum Rg value for 80 CRI products is 0. Bridgelux maintains a ± 3 tolerance on CRI and Rg values.
3. Drive current is referred to as nominal drive current.
4. Products tested under pulsed condition (10ms pulse width) at nominal drive current where T_j (junction temperature) - T_c (case temperature) = 25°C .
5. Typical performance values are provided as a reference only and are not a guarantee of performance.
6. Bridgelux maintains a $\pm 7\%$ tolerance on flux measurements.
7. Minimum flux values at the nominal drive current are guaranteed by 100% test.

Product Selection Guide

Table 2: Selection Guide, Stabilized DC Performance ($T_c = 85^\circ\text{C}$)^{4,5}

Part Number	Nominal CCT ¹ (K)	CRI ²	Nominal Drive Current ³ (mA)	Typical DC Flux ^{4,5} $T_c = 85^\circ\text{C}$ (lm)	Minimum DC Flux ⁶ $T_c = 85^\circ\text{C}$ (lm)	Typical V_f (V)	Typical Power (W)	Typical Efficacy (lm/W)
BXRE-27E08F0-D-gx	2700	80	300	875	787	16.6	5.0	176
BXRE-27E08F0-E-gx	2700	80	150	875	787	33.3	5.0	175
BXRE-30E08F0-D-gx	3000	80	300	892	803	16.6	5.0	179
BXRE-30E08F0-E-gx	3000	80	150	892	803	33.3	5.0	179
BXRE-35E08F0-D-gx	3500	80	300	897	807	16.6	5.0	180
BXRE-35E08F0-E-gx	3500	80	150	897	807	33.3	5.0	179
BXRE-40E08F0-D-gx	4000	80	300	901	811	16.6	5.0	181
BXRE-40E08F0-E-gx	4000	80	150	901	811	33.3	5.0	180
BXRE-50E08F0-D-gx	5000	80	300	883	795	16.6	5.0	177
BXRE-50E08F0-E-gx	5000	80	150	883	795	33.3	5.0	177

Notes for Table 2:

1. Nominal CCT as defined by ANSI C78.377-2011.
2. CRI values are minimums and tested at $T_j = T_c = 85^\circ\text{C}$. Minimum Rg value for 80 CRI products is 0, Bridgelux maintains a ± 3 tolerance on CRI and Rg values.
3. Drive current is referred to as nominal drive current.
4. Typical stabilized DC performance values are provided as reference only and are not a guarantee of performance.
5. Typical performance is estimated based on operation under DC (direct current) with LED array mounted onto a heat sink with thermal interface material and the case temperature maintained at 85°C . Based on Bridgelux test setup, values may vary depending on the thermal design of the luminaire and/or the exposed environment to which the product is subjected.
6. Minimum flux values at elevated temperatures are provided for reference only and are not guaranteed by 100% production testing. Based on Bridgelux test setup, values may vary depending on the thermal design of the luminaire and/or the exposed environment to which the product is subjected.

European Product Registry for Energy Labeling

The European Product Registry for Energy Labeling (EPREL) is defined in the EU Regulation 2017/1369 to provide important energy efficiency information to consumers. Together with Energy Labeling Regulation ELR (EU) 2019/2015 which was amended by regulation (EU) 2021/340 for energy labelling of light sources, manufacturers are required to declare an energy class based on key technical specifications from each of their product and register it in an open data base managed by EPREL. It is now a legal requirement for a vendor of light sources to upload information about their products into the EPREL database before placing these products on the market in the EU.

Table 3 below provides a list of part numbers that are in compliance with ELR and are currently listed in the EPREL database.

At Bridgelux, we are fully committed to supplying products that are compliant with pertinent laws, rules, and obligation imposed by relevant government bodies including the European Energy Labeling regulation. Customers can use these products with full confidence for any projects that fall under the ELR.

Table 3: Part numbers registered in European Product Registry for Energy Labeling

PART NUMBER ¹	CCT (K)	CRI	Current ² (mA)	Vf (V)	Useful flux ³ (Φ_{use}) at 85C (lm)	Power (W)	Efficacy (lm/W)	Energy efficiency class ⁴	Registration No	URL to Product Information Sheet in EPREL Database
BXRE-27E08F0-D-93	2700	80	720	18.7	1856	13	138	E	1702059	https://eprelec.europa.eu/qr/1702059
BXRE-27E08F0-E-93	2700	80	360	37.5	1856	14	137	E	1702060	https://eprelec.europa.eu/qr/1702060
BXRE-30E08F0-D-93	3000	80	720	18.7	1893	13	141	E	1702074	https://eprelec.europa.eu/qr/1702074
BXRE-30E08F0-E-93	3000	80	360	37.5	1893	14	140	E	1702075	https://eprelec.europa.eu/qr/1702075
BXRE-35E08F0-D-93	3500	80	720	18.7	1903	13	141	E	1702089	https://eprelec.europa.eu/qr/1702089
BXRE-35E08F0-E-93	3500	80	360	37.5	1903	14	141	E	1702090	https://eprelec.europa.eu/qr/1702090
BXRE-40E08F0-D-93	4000	80	720	18.7	1913	13	142	E	1702104	https://eprelec.europa.eu/qr/1702104
BXRE-40E08F0-E-93	4000	80	360	37.5	1913	14	142	E	1702105	https://eprelec.europa.eu/qr/1702105
BXRE-50E08F0-D-94	5000	80	720	18.7	1874	13	139	E	1702123	https://eprelec.europa.eu/qr/1702123
BXRE-50E08F0-E-94	5000	80	360	37.5	1874	14	139	E	1702125	https://eprelec.europa.eu/qr/1702125

Notes for Table 3:

1. All device listed here must be disposed as e-waste upon its end of life according to local country guideline in each country.
2. For information on performance values at alternative drive conditions, please refer to the Product Selection Guide, Absolute Maximum Rating Table and Performance Curves in this data sheet.
3. For a definition of useful luminous flux (Φ_{use}), please see the ELR regulations at <https://tinyurl.com/4b6zvt4m>.
4. EPREL requires an arrow symbol containing the letter of the energy efficiency class to be displayed, on technical promotional material. Refer to this energy efficiency class column for specific energy efficiency class on each part number.

Performance at Commonly Used Drive Currents

V Series LED arrays are tested to the specifications shown using the nominal drive currents in Table 1. V Series may also be driven at other drive currents dependent on specific application design requirements. The performance at any drive current can be derived from the current vs. voltage characteristics shown in Figures 1 & 2 and the flux vs. current characteristics shown in Figures 3 & 4. The performance at commonly used drive currents is summarized in Table 4.

Table 4: Product Performance at Commonly Used Drive Currents

Part Number	CRI	Drive Current ¹ (mA)	Typical V _f T _c = 25°C (V)	Typical Power T _c = 25°C (W)	Typical Flux ² T _c = 25°C (lm)	Typical DC Flux ³ T _c = 85°C (lm)	Typical Efficacy T _c = 25°C (lm/W)
BXRE-27E08F0-D-gx	80	100	15.8	1.6	326	304	206
		200	16.4	3.3	646	599	197
		240	16.6	4.0	769	711	193
		300	16.9	5.1	951	875	187
		540	17.9	9.7	1639	1478	169
		720	18.7	13.5	2131	1897	158
BXRE-27E08F0-E-gx	80	50	31.7	1.6	326	304	206
		100	32.9	3.3	646	599	196
		120	33.3	4.0	769	711	192
		150	33.9	5.1	951	875	187
		270	35.9	9.7	1639	1478	169
		360	37.5	13.5	2131	1897	158
BXRE-30E08F0-D-gx	80	100	15.8	1.6	333	311	210
		200	16.4	3.3	659	611	201
		240	16.6	4.0	785	726	197
		300	16.9	5.1	970	892	191
		540	17.9	9.7	1673	1508	173
		720	18.7	13.5	2175	1935	162
BXRE-30E08F0-E-gx	80	50	31.7	1.6	333	311	210
		100	32.9	3.3	659	611	200
		120	33.3	4.0	785	726	196
		150	33.9	5.1	970	892	191
		270	35.9	9.7	1673	1508	172
		360	37.5	13.5	2175	1935	161
BXRE-35E08F0-D-gx	80	100	15.8	1.6	335	312	211
		200	16.4	3.3	662	614	202
		240	16.6	4.0	789	729	198
		300	16.9	5.1	975	897	192
		540	17.9	9.7	1681	1516	174
		720	18.7	13.5	2186	1945	162
BXRE-35E08F0-E-gx	80	50	31.7	1.6	335	312	211
		100	32.9	3.3	662	614	201
		120	33.3	4.0	789	729	197
		150	33.9	5.1	975	897	192
		270	35.9	9.7	1681	1516	173
		360	37.5	13.5	2186	1945	162

Notes for Table 4:

1. Alternate drive currents in Table 4 are provided for reference only and are not a guarantee of performance.
2. Bridgelux maintains a ± 7% tolerance on flux measurements.
3. Typical stabilized DC performance values are provided as reference only and are not a guarantee of performance.

Performance at Commonly Used Drive Currents

Table 4: Product Performance at Commonly Used Drive Currents (Continued)

Part Number	CRI	Drive Current ¹ (mA)	Typical V _f T _c = 25°C (V)	Typical Power T _c = 25°C (W)	Typical Flux ² T _c = 25°C (lm)	Typical DC Flux ³ T _c = 85°C (lm)	Typical Efficacy T _c = 25°C (lm/W)
BXRE-40E08F0-D-gx	80	100	15.8	1.6	336	314	213
		200	16.4	3.3	665	617	203
		240	16.6	4.0	793	733	199
		300	16.9	5.1	980	901	193
		540	17.9	9.7	1689	1523	175
		720	18.7	13.5	2197	1955	163
BXRE-40E08F0-E-gx	80	50	31.7	1.6	336	314	212
		100	32.9	3.3	665	617	202
		120	33.3	4.0	793	733	198
		150	33.9	5.1	980	901	193
		270	35.9	9.7	1689	1523	174
		360	37.5	13.5	2197	1955	163
BXRE-50E08F0-D-gx	80	100	15.8	1.6	330	307	208
		200	16.4	3.3	652	605	199
		240	16.6	4.0	777	718	195
		300	16.9	5.1	960	883	189
		540	17.9	9.7	1656	1493	171
		720	18.7	13.5	2153	1916	160
BXRE-50E08F0-E-gx	80	50	31.7	1.6	330	307	208
		100	32.9	3.3	652	605	198
		120	33.3	4.0	777	718	194
		150	33.9	5.1	960	883	189
		270	35.9	9.7	1656	1493	171
		360	37.5	13.5	2153	1916	159

Notes for Table 4:

1. Alternate drive currents in Table 4 are provided for reference only and are not a guarantee of performance.
2. Bridgelux maintains a ± 7% tolerance on flux measurements.
3. Typical stabilized DC performance values are provided as reference only and are not a guarantee of performance.

Electrical Characteristics

Table 5: Electrical Characteristics

Part Number	Drive Current (mA)	Forward Voltage Pulsed, $T_c = 25^\circ\text{C}$ (V) ^{1, 2, 3, 8}			Typical Coefficient of Forward Voltage ⁴ $\Delta V_f / \Delta T_c$ (mV/ $^\circ\text{C}$)	Typical Thermal Resistance Junction to Case ^{5,6} R_{j-c} ($^\circ\text{C}/\text{W}$)	Driver Selection Voltages ⁷ (V)	
		Minimum	Typical	Maximum			V_f Min. Hot $T_c = 95^\circ\text{C}$ (V)	V_f Max. Cold $T_c = -40^\circ\text{C}$ (V)
BXRE-xxx08Fx-D-gx	300	15.9	16.9	17.9	-13.32	0.79	15.5	18.5
	720	17.6	18.7	19.8	-14.74	1.13	17.1	20.5
BXRE-xxx08Fx-E-gx	150	31.9	33.9	35.9	-13.32	0.79	31.1	37.2
	360	35.3	37.5	39.8	-14.74	1.13	34.4	41.2

Notes for Table 5:

- Parts are tested in pulsed conditions, $T_c = 25^\circ\text{C}$. Pulse width is 10ms.
- Voltage minimum and maximum are provided for reference only and are not a guarantee of performance.
- Bridgelux maintains a tester tolerance of $\pm 0.10\text{V}$ on forward voltage measurements.
- Typical coefficient of forward voltage tolerance is $\pm 0.1\text{mV}$ for nominal current.
- Thermal resistance values are based from test data of a 3000K 80 CRI product.
- Thermal resistance value was calculated using total electrical input power; optical power was not subtracted from input power. The thermal interface material used during testing is not included in the thermal resistance value.
- V_f min hot and max cold values are provided as reference only and are not guaranteed by test. These values are provided to aid in driver design and selection over the operating range of the product.
- This product has been designed and manufactured per IEC 62031:2018.

Eye Safety

Table 6: Eye Safety Risk Group (RG) Classifications

Part Number	Drive Current (mA)	CCT ⁴		
		2700K/3000K	3500K/4000K ²	5000K ³
BXRE-xxx08Fx-D-gx	590	RG1	RG1	RG1
	720	RG1	RG1	RG2
BXRE-xxx08Fx-E-gx	290	RG1	RG1	RG1
	360	RG1	RG1	RG2

Notes for Table 6:

1. Eye safety classification for the use of Bridgelux V Series LED arrays is in accordance with specification IEC/TR 62778: Application of IEC 62471 for the assessment of blue light hazard to light sources and luminaires.
2. For products classified as RG2 at 4000K, Ethr= 1860 lx.
3. For products classified as RG2 at 5000K Ethr= 1400 lx.
4. Please contact your Bridgelux sales representative for Ethr values at specific drive currents and CCTs not listed.

Absolute Maximum Ratings

Table 7: Maximum Ratings

Parameter	Maximum Rating	
LED Junction Temperature (T_j)	150°C	
Storage Temperature ¹	-40°C to +95°C	
Operating Case Temperature ² (T_c)	95°C	
Soldering Temperature ³	300°C or lower for a maximum of 6 seconds	
	BXRE-xxx08Fx-D-gx	BXRE-xxx08Fx-E-gx
Maximum Drive Current ⁴	720 mA at $\leq 85^\circ\text{C}$ 540 mA at 95°C	360 mA at $\leq 85^\circ\text{C}$ 270 mA at 95°C
Maximum Peak Pulsed Drive Current ⁵	1030 mA	510 mA
Maximum Reverse Voltage ⁶	-30V	-60V

Notes for Table 7:

1. The Gen 9 product is robust enough to pass our internal humidity test but it is still more sensitive compared to regular LED array product. The product needs to be stored in a dry environment. It is not recommended to use the product in a damp environment that directly exposes it to moisture.
2. For IEC 62717 requirement, please consult your Bridgelux sales representative.
3. Refer to Bridgelux Application Note AN101: Handling and Assembly of Bridgelux V Series LED Arrays
4. Arrays may be driven at higher currents however lumen maintenance may be reduced and warranty will not apply.
5. Bridgelux recommends a maximum duty cycle of 10% and pulse width of 20 ms when operating LED Arrays at maximum peak pulsed current specified. Maximum peak pulsed currents indicate values where LED Arrays can be driven without catastrophic failures.
6. Light emitting diodes are not designed to be driven in reverse voltage and will not produce light under this condition. Maximum rating provided for reference only.

Performance Curves

Figure 1: V8D Drive Current vs. Voltage

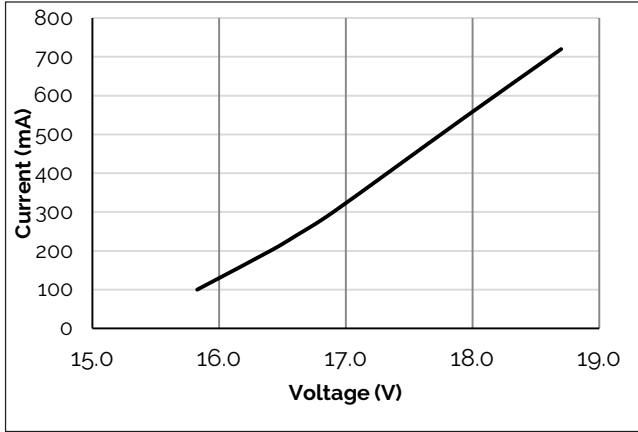

Figure 2: V8E Drive Current vs. Voltage

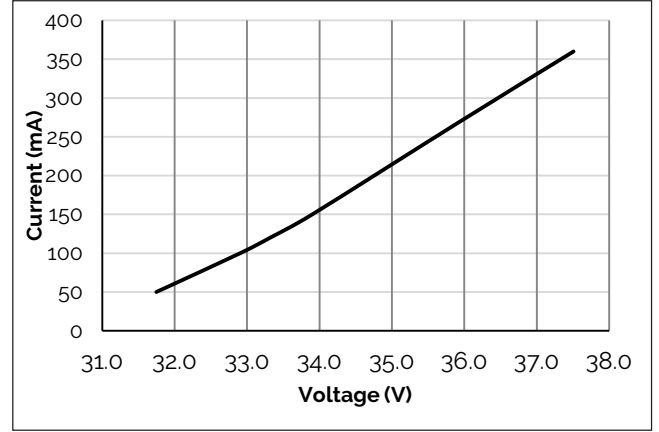

Figure 3: V8D Typical Relative Flux vs. Current

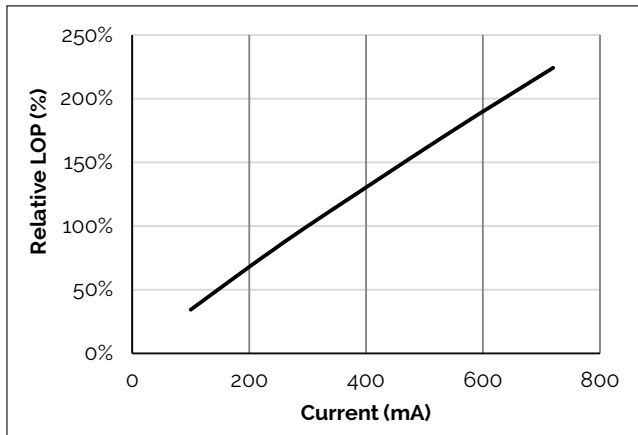

Figure 4: V8E Typical Relative Flux vs. Current

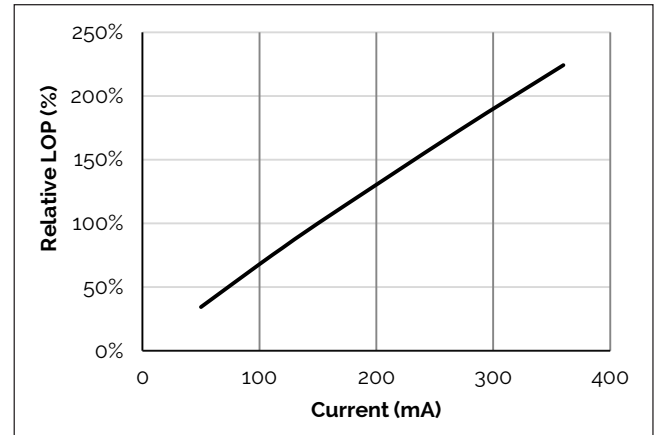

Figure 5: Typical DC Flux vs. Case Temperature

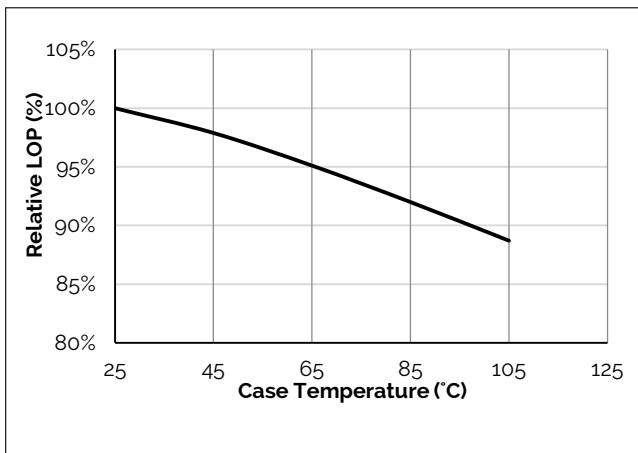
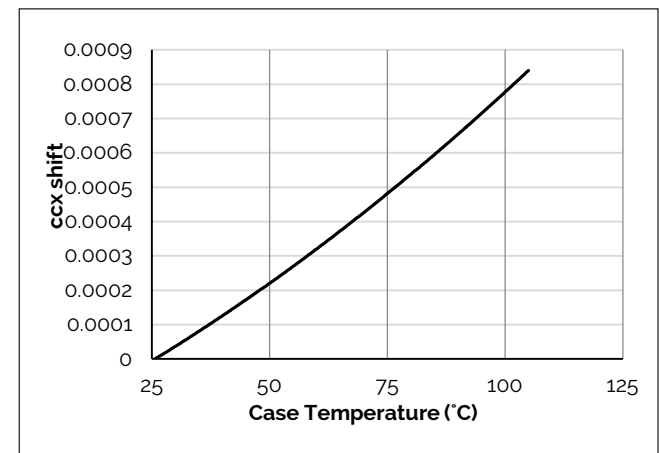

Figure 6: Typical DC ccx Shift vs. Case Temperature



Notes for Figures 1-4:

1. Bridgelux does not recommend driving high power LEDs at low currents. Doing so may produce unpredictable results. Pulse width modulation (PWM) is recommended for dimming effects.
2. Products tested under pulsed condition (10ms pulse width) at nominal drive current where T_j (junction temperature) = T_c (case temperature) = 25°C.

Note for Figures 5-6:

1. Characteristics shown for Warm White.

Performance Curves

Figure 7: Typical DC ccy Shift vs. Case Temperature

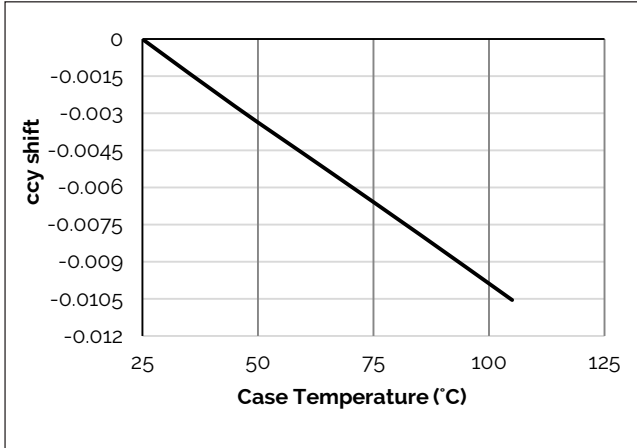

Figure 8: V8D Drive Current vs. ccx Shift

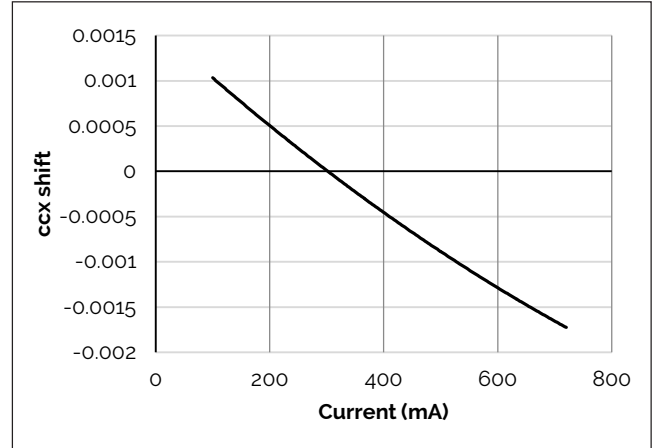

Figure 9: V8D Drive Current vs. ccy Shift

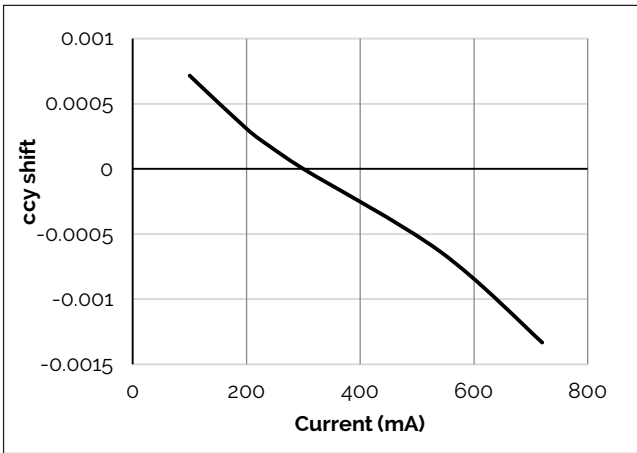

Figure 10: V8E Drive Current vs. ccx Shift

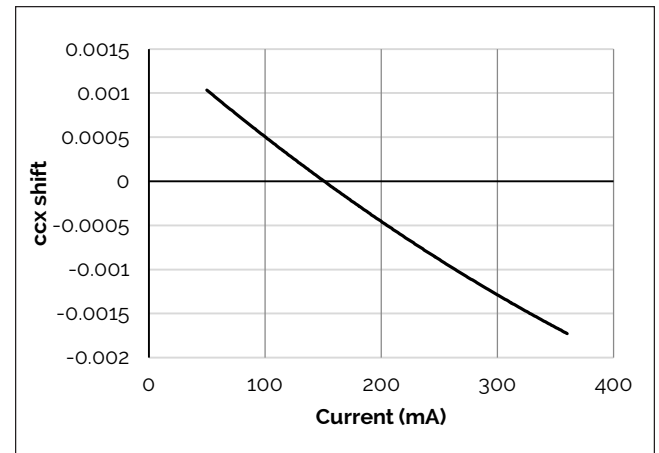

Figure 11: V8E Drive Current vs. ccy Shift

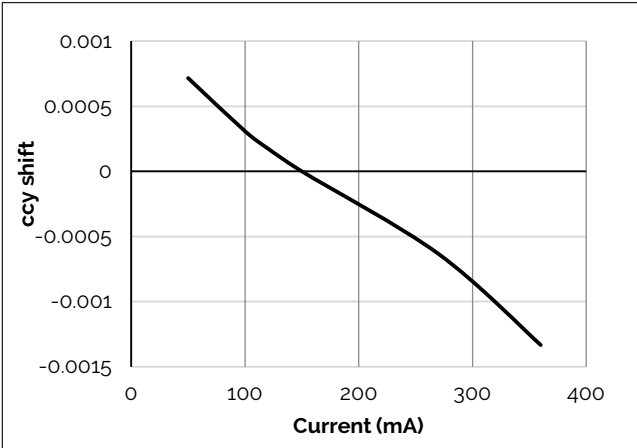
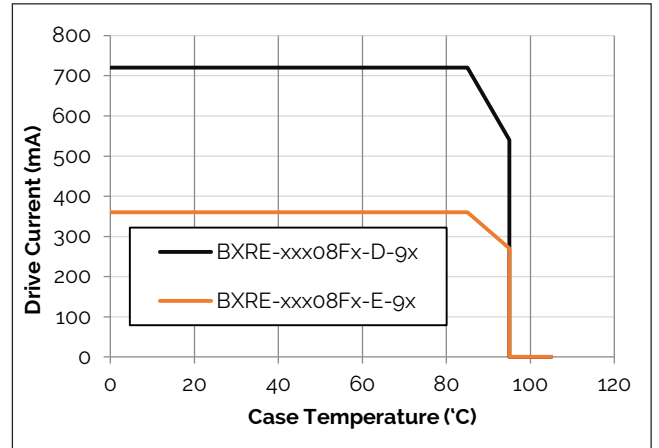

Figure 12: Derating Curve



Note for Figures 7-11:
1. Characteristics shown for Warm White.

Typical Radiation Pattern

Figure 13: Typical Spatial Radiation Pattern

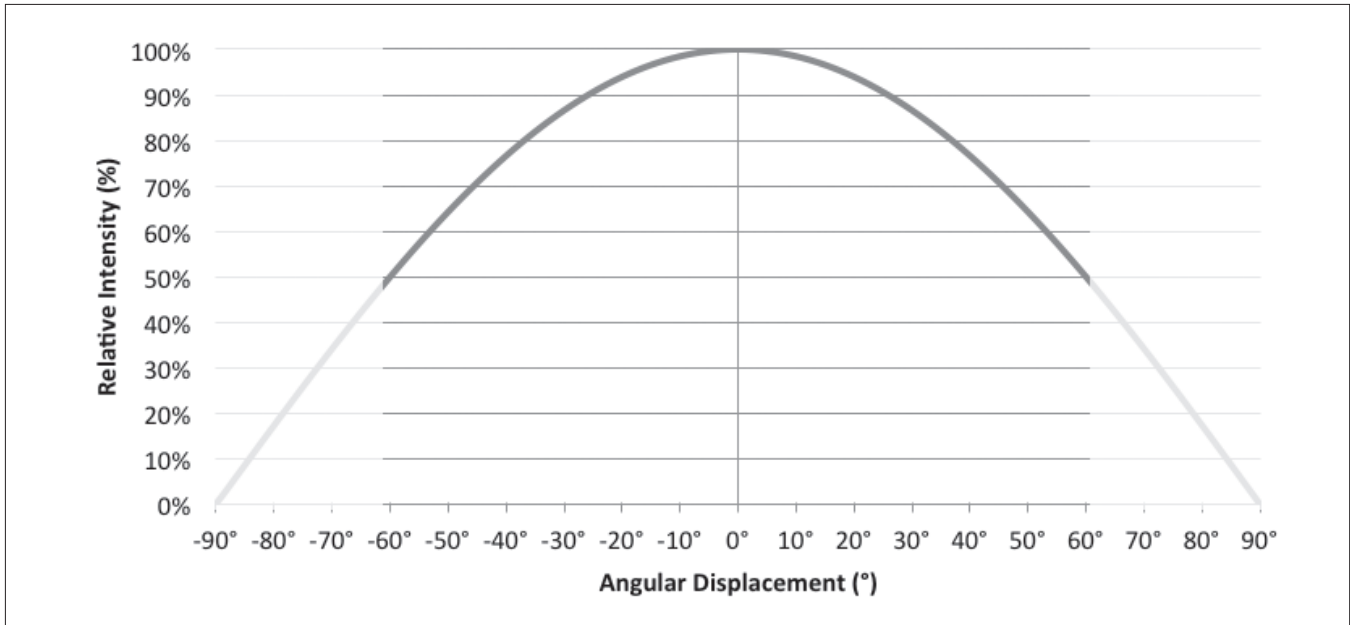

Notes for Figure 13:

1. Typical viewing angle is 120°.
2. The viewing angle is defined as the off axis angle from the centerline where intensity is ½ of the peak value.

Figure 14: Typical Polar Radiation Pattern

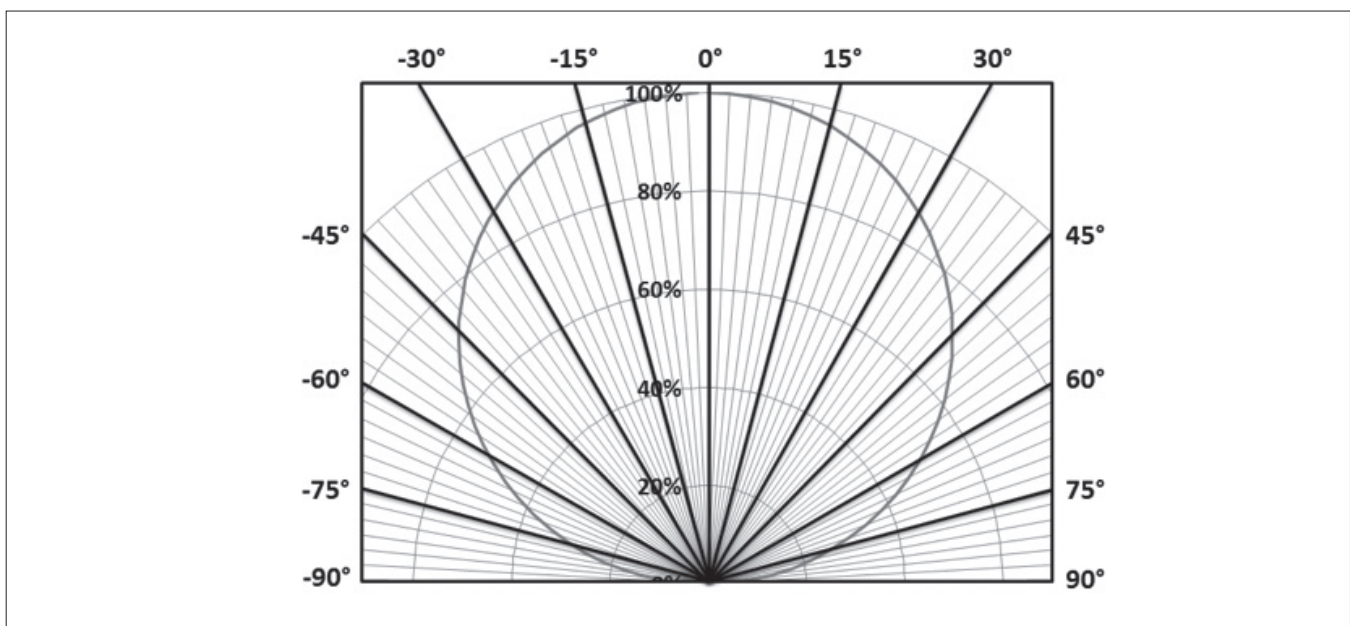

Typical Color Spectrum

Figure 15: Typical Color Spectrum

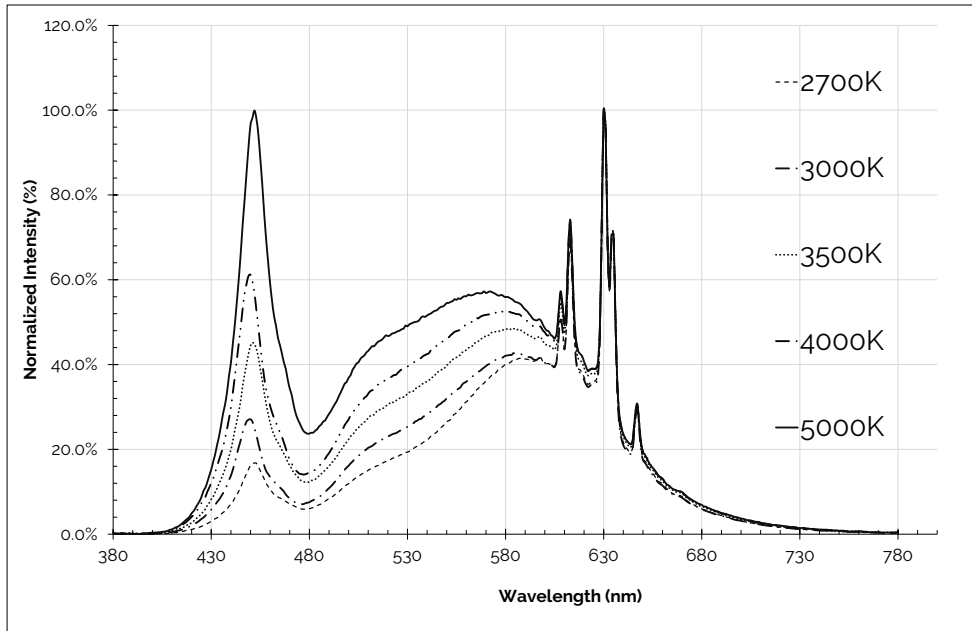

Notes for Figure 15:

1. Color spectra measured at nominal current for $T_j = T_c = 85^\circ\text{C}$.
2. Color spectra shown is 2700K and 80CRI.
3. Color spectra shown is 3000K and 80 CRI.
4. Color spectra shown is 3500K and 80 CRI.
5. Color spectra shown is 4000K and 80 CRI.
6. Color spectra shown is 5000K and 80 CRI.

Mechanical Dimensions

Figure 16: Drawing for V8 LED Array

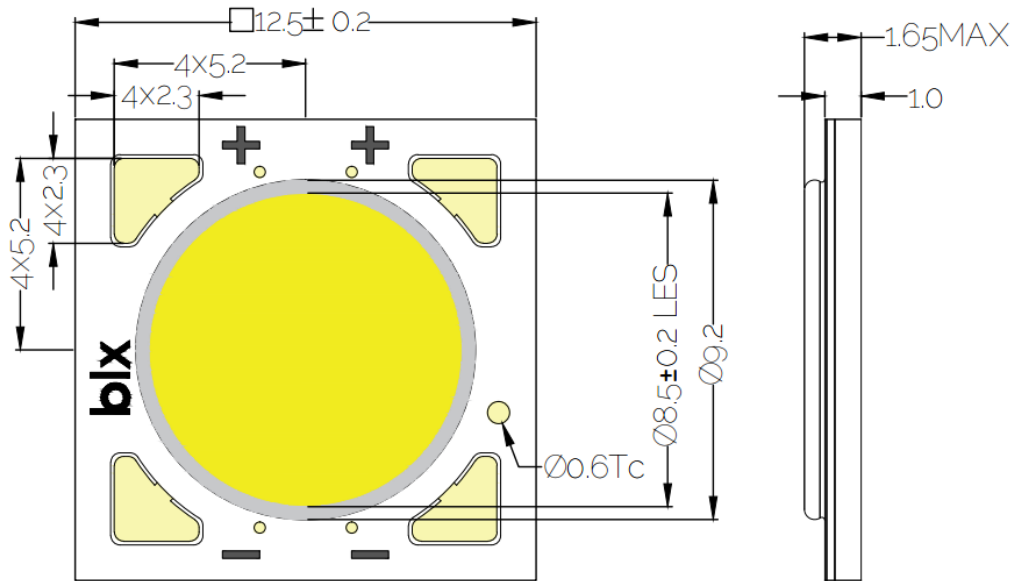

Notes for Figure 16:

1. Drawings are not to scale.
2. Drawing dimensions are in millimeters.
3. Solder pads are labeled "+" and "-" to denote positive and negative polarity, respectively.
4. Unless otherwise specified, tolerances are ± 0.1 mm.
5. Refer to Application Notes AN101 for product handling, mounting and heat sink recommendations.
6. The optical center of the LED Array is nominally defined by the mechanical center of the array to a tolerance of ± 0.2 mm.
7. Bridgelux maintains a flatness of 0.10 mm across the mounting surface of the array.

Color Binning Information

Figure 17: Warm, Neutral and Cool White Test Bins in xy Color Space

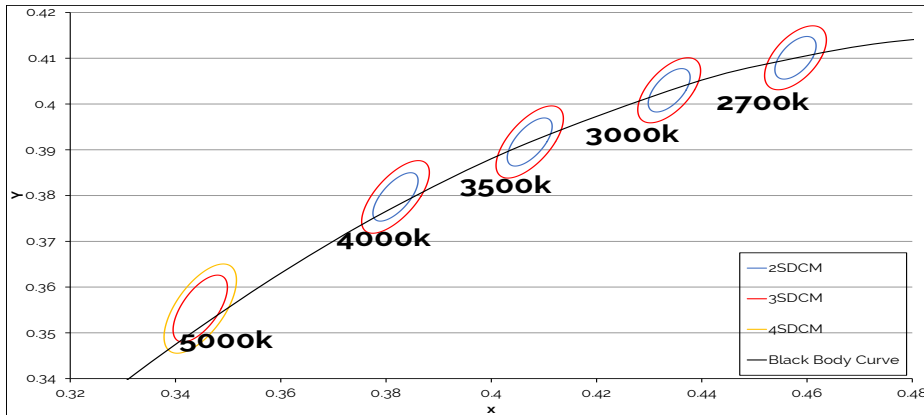

Note: Pulsed Test Conditions, $T_c = 85^\circ\text{C}$

Table 8: Warm and Neutral White xy Bin Coordinates and Associated Typical CCT (product is hot targeted to $T_c = 85^\circ\text{C}$)

Bin Code	2700K	3000K	3500K	4000K
ANSI Bin (for reference only)	(2580K - 2870K)	(2870K - 3220K)	(3220K - 3710K)	(3710K - 4260K)
g3 (3 SDCM)	(2651K - 2794K)	(2968K - 3136K)	(3369K - 3586K)	(3851K - 4130K)
g2 (2 SDCM)	(2674K - 2769K)	(2995K - 3107K)	(3404K - 3548K)	(3895K - 4081K)
Center Point (x,y)	(0.4578, 0.4101)	(0.4338, 0.403)	(0.4073, 0.3917)	(0.3818, 0.3797)

Table 9: Cool White xy Bin Coordinates and Associated Typical CCT (product is hot targeted to $T_c = 85^\circ\text{C}$)

Bin Code	5000K
ANSI Bin (for reference only)	(4745K - 5311K)
g4 (4 SDCM)	(4801K - 5282K)
g3 (3 SDCM)	(4835K - 5215K)
Center Point (x,y)	(0.3447, 0.3553)

Note for Tables 8-g:

1. Bridgelux maintains a tolerance of +/- 0.007 on x and y color coordinates in the CIE 1931 color Space.

Packaging and Labeling

Figure 18: V8 Packaging Tubes



Notes for Figure 18:

1. Each tube holds 40 V8 COB arrays.
2. One tube is sealed in an anti-static bag. Four bags are placed in a shipping box. Depending on quantities ordered, a bigger shipping box, containing four boxes may be used to ship products.
3. Each bag and box is to be labeled as shown above.
4. Dimensions for each tube are 21.3 (W) x 9.5(H) x 505 (L). Dimensions for the anti-static bag are 75 (W) x 615 (L) x 3.1 (T) mm. Dimensions for the shipping box are 58.7 x 13.3 x 7.9 cm.

Packaging and Labeling

Figure 19: Gen. 9 Product Labeling

Bridgelux COB arrays have laser markings on the back side of the substrate to help with product identification. In addition to the product identification markings, Bridgelux COB arrays also contain markings for internal Bridgelux manufacturing use only. The image below shows which markings are for customer use and which ones are for Bridgelux internal use only. The Bridgelux internal manufacturing markings are subject to change without notice, however these will not impact the form, function or performance of the COB array.

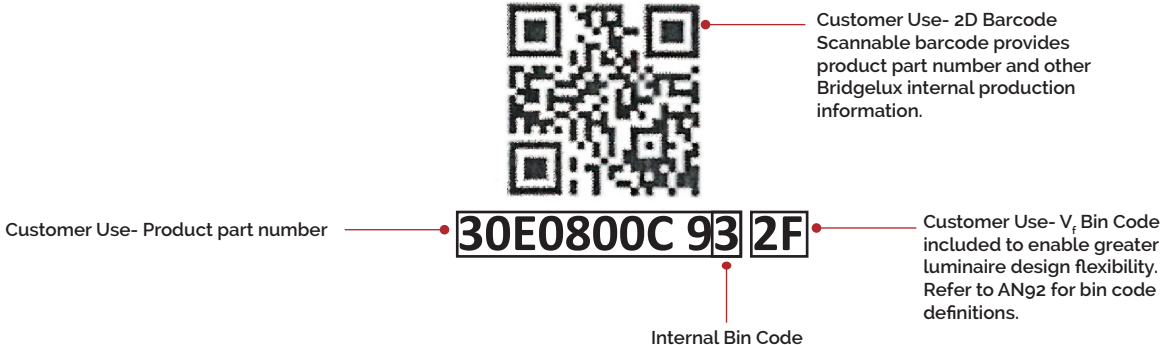

Design Resources

Application Notes

Bridgelux has developed a comprehensive set of application notes and design resources to assist customers in successfully designing with the V Series product family of LED array products. For all available application notes visit www.bridgelux.com.

Optical Source Models

Optical source models and ray set files are available for all Bridgelux products. For a list of available formats, visit www.bridgelux.com.

3D CAD Models

Three dimensional CAD models depicting the product outline of all Bridgelux V Series LED arrays are available in both IGS and STEP formats. Please contact your Bridgelux sales representative for assistance.

LM80

LM80 testing has been completed and the LM80 report is now available. Please contact your Bridgelux sales representative for LM-80 report.

Precautions

CAUTION: CHEMICAL EXPOSURE HAZARD

Exposure to some chemicals commonly used in luminaire manufacturing and assembly can cause damage to the LED array. Please consult Bridgelux Application Note AN101 for additional information.

CAUTION: RISK OF BURN

Do not touch the V Series LED array during operation. Allow the array to cool for a sufficient period of time before handling. The V Series LED array may reach elevated temperatures such that could burn skin when touched.

CAUTION

CONTACT WITH LIGHT EMITTING SURFACE (LES)

Avoid any contact with the LES. Do not touch the LES of the LED array or apply stress to the LES (yellow phosphor resin area). Contact may cause damage to the LED array.

Optics and reflectors must not be mounted in contact with the LES (yellow phosphor resin area).

Disclaimers

MINOR PRODUCT CHANGE POLICY

The rigorous qualification testing on products offered by Bridgelux provides performance assurance. Slight cosmetic changes that do not affect form, fit, or function may occur as Bridgelux continues product optimization.

STANDARD TEST CONDITIONS

Unless otherwise stated, array testing is performed at the nominal drive current.

About Bridgelux: Bridging Light and Life™

At Bridgelux, we help companies, industries and people experience the power and possibility of light. Since 2002, we've designed LED solutions that are high performing, energy efficient, cost effective and easy to integrate. Our focus is on light's impact on human behavior, delivering products that create better environments, experiences and returns—both experiential and financial. And our patented technology drives new platforms for commercial and industrial luminaires.

For more information about the company, please visit
bridgelux.com
twitter.com/Bridgelux
facebook.com/Bridgelux
youtube.com/user/Bridgelux
linkedin.com/company/bridgelux-inc-_2
WeChat ID: BridgeluxInChina



46410 Fremont Boulevard
Fremont, CA 94538 U.S.A.
Tel (925) 583-8400
www.bridgelux.com

© 2023 Bridgelux, Inc. All rights reserved. Product specifications are subject to change without notice. Bridgelux, the Bridgelux stylized logo design and Vero are registered trademarks. V Series and Decor Series are trademarks of Bridgelux, Inc. All other trademarks are the property of their respective owners.

Bridgelux GENg V8 Array Series Product Data Sheet DS1306 Rev. A (08/2023)