

Isolated Flyback Converter IC With Integrated Switching MOSFET

BD7J200HFN-LB BD7J200EFJ-LB BD7J200UEFJ-LB

General Description

This is the product guarantees long time support in Industrial market.

This IC is an optocoupler-less isolated flyback converter. It is not necessary to use any optocouplers and feedback circuits by a third winding of transformers; these have been ever required to obtain a stable output voltage in former applications. Furthermore, adoption of the original adapted type technology that controls on time makes the external phase compensation parts unnecessary, reduces a lot of parts number and minimalizes applications, which realizes the designs of isolated power supply application with high reliability.

Features

- Long Time Support Product for Industrial Applications
- No Need of Any Optocoupler and Third Winding of Transformer
- Set Output Voltage with Two External Resistor and Ratio of Transformer Turns
- Adopt of Original Adapted Type Technology that Controls On Time.
- No Need of External Phase Compensation Parts by High-speed Load Response
- Low Output Ripple by Fixed Switching Frequency (At normal operation)
- High Efficient Light Load Mode (At PFM operation)
- Shutdown and Enable Control
- Built-in 120 V Switching MOSFET
- Soft Start Function
- Load Compensation Function
- Various Protection Function
 - Input Under Voltage Lockout (VIN UVLO)
 - Over Current Protection (OCP)
 - Over Voltage Protection (OVP)
 - Short Circuit Protection (SCP)
 - Thermal Shutdown (TSD)
 - Battery Short Protection (BSP)

Key Specifications

- Operation Supply Voltage Range
VIN Pin: 8 V to 80 V
SW Pin: 120 V (Max)
- Over Current Detection Current: 1.75 A (Typ)
- Switching Frequency: 400 kHz (Typ)
- Reference Voltage Accuracy: ±1.5 %
- Current at Shutdown: 0 μA (Typ)
- Operation Current at Switching: 2.8 mA (Typ)
- Operation Temperature Range: -40 °C to +125 °C

Packages

HSO8
(BD7J200HFN-LB)

W (Typ) x D (Typ) x H (Max)

2.9 mm x 3.0 mm x 0.6 mm

HTSOP-J8

(BD7J200EFJ-LB BD7J200UEFJ-LB)

4.9 mm x 6.0 mm x 1.0 mm

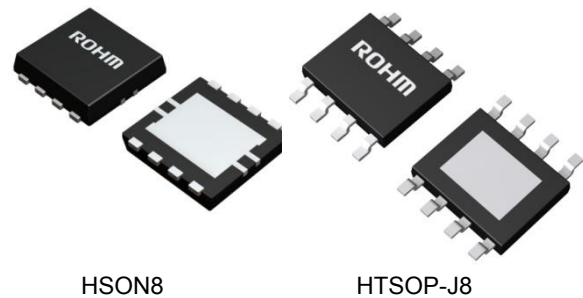

HSON8

HTSOP-J8

Application

- Isolated Power Supply for Industrial Equipment

Typical Application Circuit

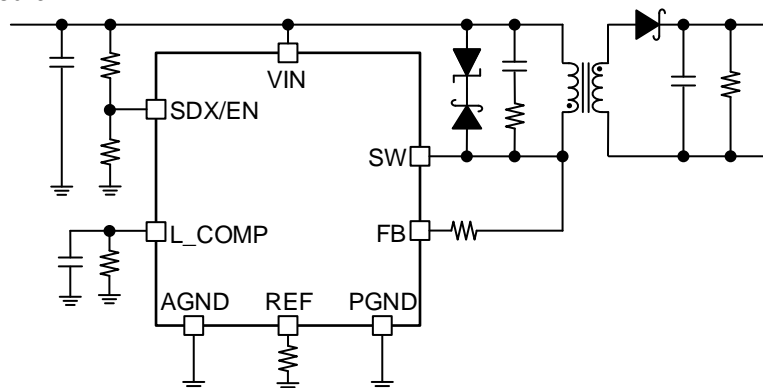

○Product structure : Silicon integrated circuit ○This product has no designed protection against radioactive rays.

Pin Configurations

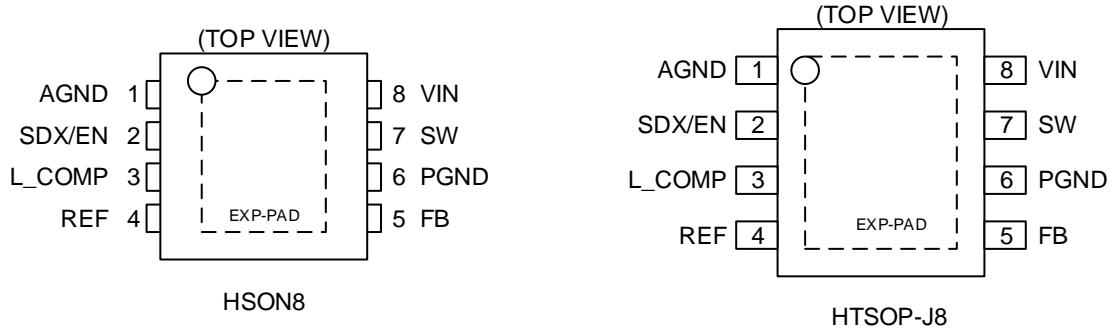

Pin Descriptions

Pin No.	Pin Name	Function
1	AGND	Analog system GND pin
2	SDX/EN	Shutdown and enable control pin
3	L_COMP	Setting pin of the load current compensation value
4	REF	Setting pin of the output voltage
5	FB	Setting pin of the output voltage
6	PGND	Power system GND pin
7	SW	Switching output pin
8	VIN	Power supply input pin
-	EXP-PAD	Connect EXP-PAD to both of the AGND and PGND pins

Block Diagram

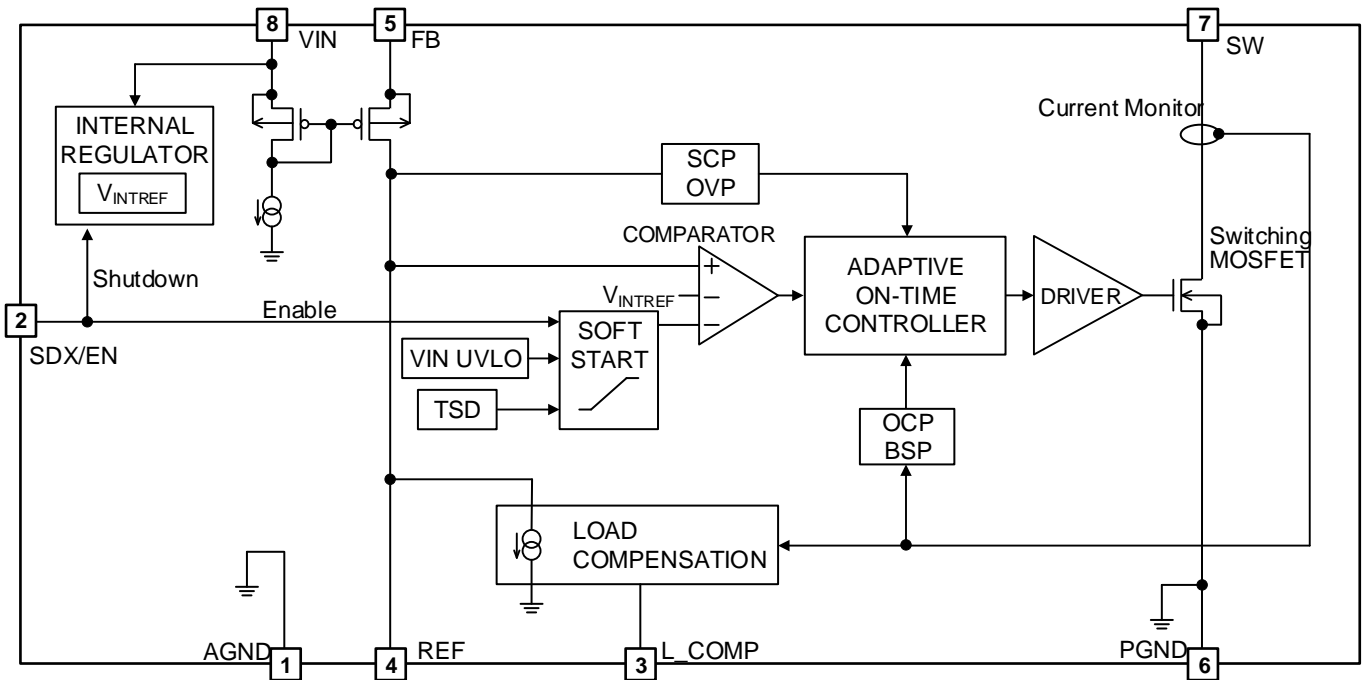

Description of Blocks

1 INTERNAL REGULATOR

This is the regulator block for internal circuits.

This block also shuts itself down at the shutdown status of the SDX/EN pin voltage $\leq V_{SDX}$.

The SDX/EN pin voltage becomes V_{EN1} or more, the IC becomes enable status and the output voltage rises slowly by the soft start function. The SDX/EN pin voltage becomes V_{EN2} or less, the IC becomes disable status and stops the switching operation.

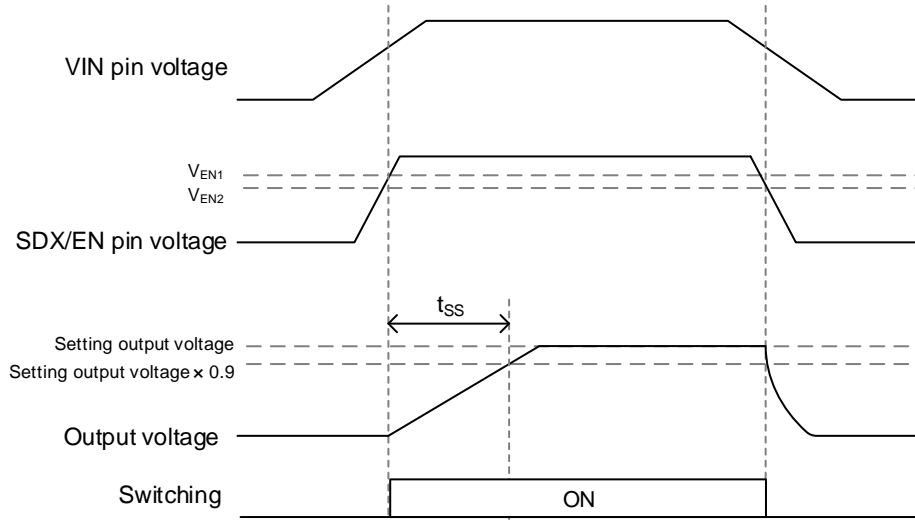

Figure 1. Startup and Stop Timing Chart

In the control method of this IC, it is necessary to operate in the status that the duty is D_{MAX} or less. At the startup and stop, set the VIN pin voltage V_{IN} to meet the next formula.

$$V_{IN} > \frac{N_P}{N_S} \times (V_{OUT} + V_F) \left(\frac{1}{D_{MAX}} - 1 \right) \quad [V]$$

Where:

V_{IN} is the VIN pin voltage.

N_P is the number of winding at the primary transformer.

N_S is the number of winding at the secondary transformer.

V_{OUT} is the output voltage.

V_F is the forward voltage of the secondary output diode.

D_{MAX} is the maximum duty.

In the case that the SDX/EN pin is shorted to the VIN pin the duty becomes D_{MAX} or more at startup and stop, and there may be occur the output voltage without intending. Refer to [Application Examples: 6 Enable Voltage and Disable Voltage](#) for the enable control by the VIN pin.

Description of Blocks – continued

2 VIN UVLO

This is the input low voltage protection block.
 When the VIN pin voltage becomes V_{UVLO1} or less, the IC detects VIN UVLO and stops the switching operation because of the high impedance in the SW pin.
 When the VIN pin voltage becomes V_{UVLO2} or more, the IC automatically reset via the soft start.

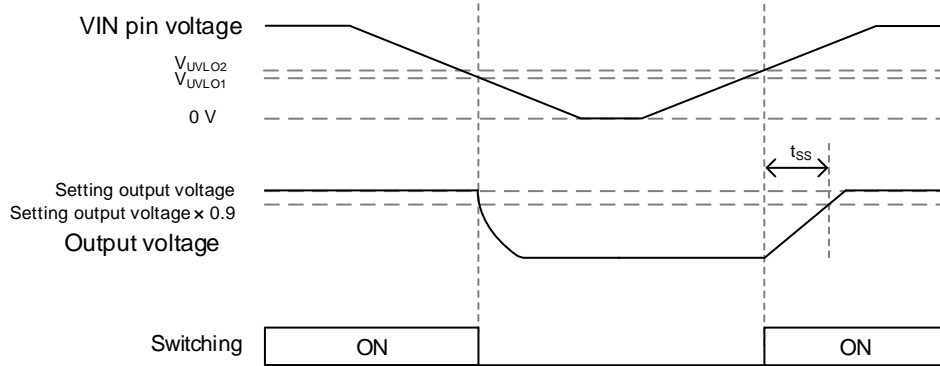

Figure 2. VIN UVLO Timing Chart

3 SOFT START

When the status becomes enable that the SDX/EN pin voltage V_{EN1} or more, the comparison voltage in the comparator block transits slowly 0 V to V_{INTREF} . This operation pretend the IC from rushing current at the rising edge of the output voltage or overshooting. The soft start time is fixed to t_{SS} in the IC.

4 COMPARATOR

In this block, the IC compare the reference voltage to the REF pin voltage that is the feedback voltage of the SW pin voltage. This IC is superior to the response for fluctuation in load because it constitutes the feedback group by the comparator.

5 ADAPTIVE ON TIME CONTROLLER

This block is corresponded to the original adapted type technology that controls on time.

- Stable load current: Operates in the PWM control and fix the on time.
- Fluctuating load current: Operates in the on time control and realizes a high-speed load response by fluctuates the switching frequency.
- Light load: Decrease the switching frequency and realizes a high efficiency.

When the load current fluctuates, the frequency becomes high. The IC raises the average of primary current by shortening the off time and raises the secondary current.

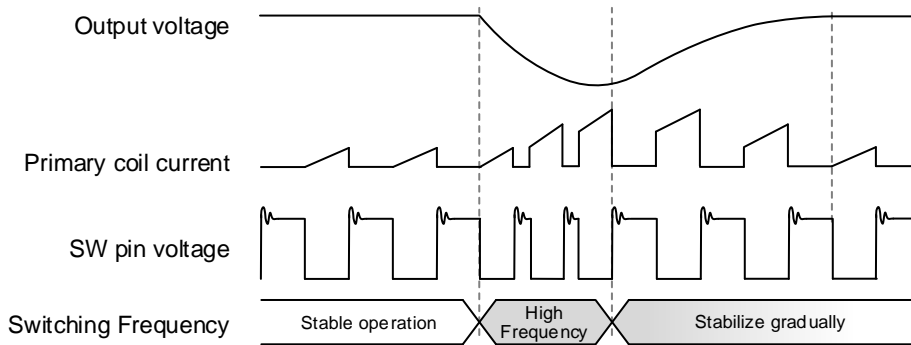

Figure 3. Transient Response Timing Chart

Description of Blocks – continued**6 DRIVER**

This block drives the switching MOSFET.

7 LOAD COMPENSATION

This block compensates the fluctuation of output voltage caused by the fluctuation of V_F characteristic in the secondary output diode corresponded to load current. This block monitors the current flowed to the switching MOSFET and pulls the current corresponded to the quantity of compensation determined by the external resistor and capacitor at the L_COMP pin and time constant from the REF pin. The decline of the REF pin voltage by the drop of feedback current flowing in the external resistor at the REF pin rises the output voltage and it is compensated.

Description of Blocks – continued

8 OCP, BSP

This is the block of the over current protection and battery short protection.

8.1 OCP (Over Current Protection)

At the switching MOSFET on, the IC detects the OCP when the peak current becomes I_{LIMIT} or more. At this moment, the switching MOSFET is turned off. Because of detecting per switching cycles and restricting on duty, the output voltage drops. In addition, to prevent detection error, the detection of OCP is invalidated for t_{MASK1} after the switching MOSFET is turned on

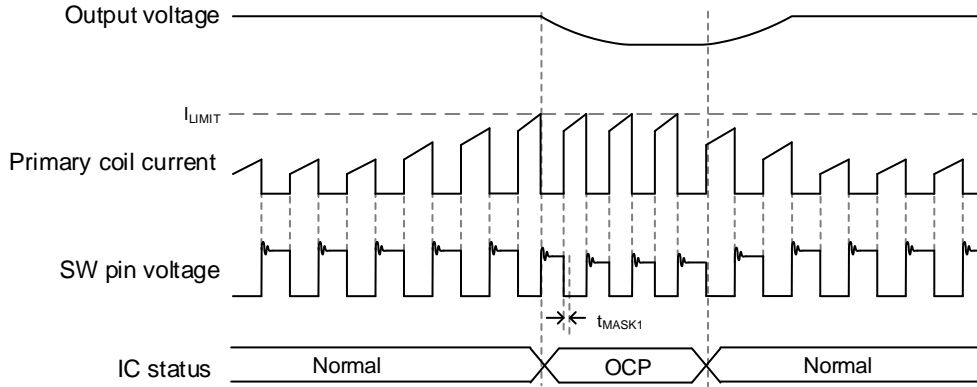

Figure 4. OCP Timing Chart

8.2 BSP (Battery Short Protection)

If the SW pin is connected to high electric potential with low impedance, current flows when the switching MOSFET turned on and it may destroy the IC. To prevent this, the IC has a built-in BSP. When the SW pin voltage becomes V_{BSP} or more at the switching MOSFET on, the IC detects BSP. At this moment, the switching operation is stopped. After $t_{RESTART}$ from the stop, the IC operates the soft start and resets.

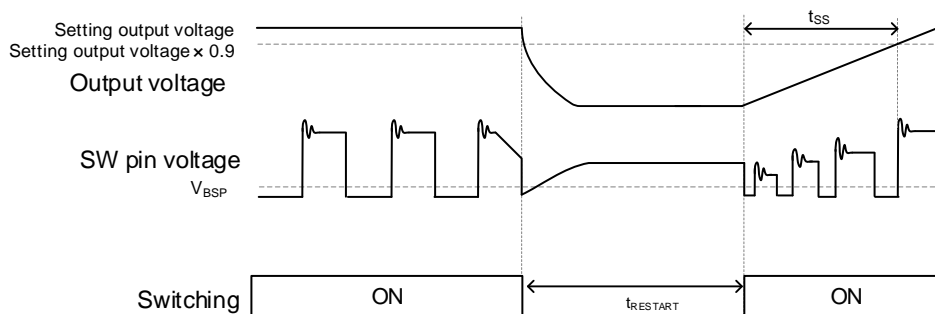

Figure 5. BPS Timing Chart

Description of Blocks – continued

9 SCP, OVP

This is the block of the short circuit protection and over voltage protection.

9.1 SCP (Short Circuit Protection)

The REF pin obtains the secondary output voltage data from the primary flyback voltage. When the REF pin voltage becomes V_{SCP} or less at the switching MOSFET off, the IC detects SCP. At this moment, the switching operation is stopped. After $t_{RESTART}$ from the stop, the IC operates the soft start and resets.

To prevent detection error, the detection of SCP is invalidated for t_{MASK2} after the switching MOSFET is turned off and for t_{MASK3} at the startup by the soft start.

In the case that the primary flyback voltage is not output correctly, SCP is not detected even if the secondary output voltage drops.

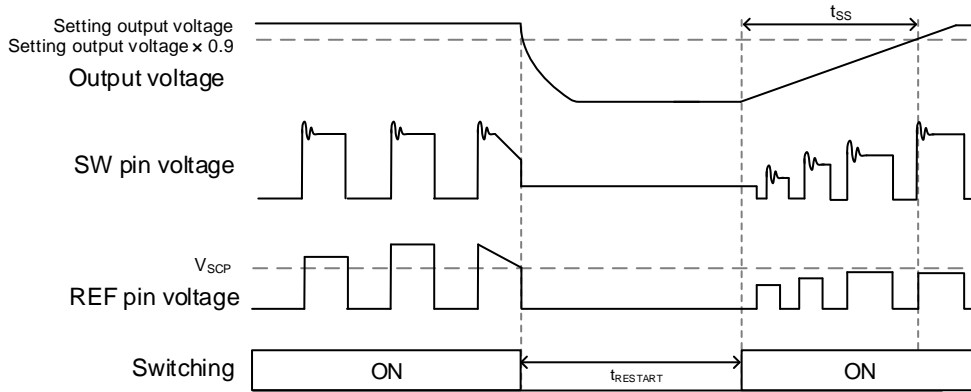

Figure 6. SCP Timing Chart

9.2 OVP (Over Voltage Protection)

The REF pin obtains the secondary output voltage data from the primary flyback voltage. When the REF pin voltage becomes V_{OVP} or more at the switching MOSFET off, the IC detects OVP. At this moment, the switching operation is stopped. After $t_{RESTART}$ from the stop, the IC operates the soft start and resets.

To prevent detection error, the detection of OVP is invalidated for t_{MASK2} after the switching MOSFET is turned off.

In the case that the primary flyback voltage is not output correctly, OVP is not detected even if the secondary output voltage rises.

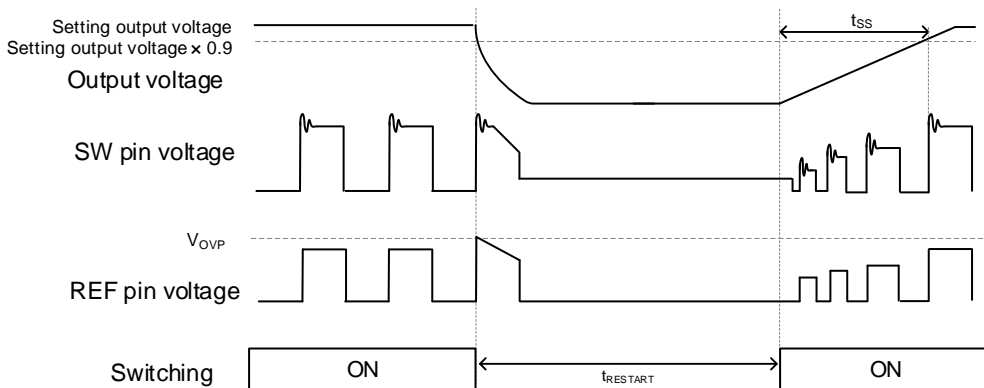

Figure 7. OVP Timing Chart

Absolute Maximum Ratings (Ta = 25 °C)

Parameter	Symbol	Rating	Unit
VIN Pin Voltage	V _{IN_MAX}	100	V
SW Pin Voltage	V _{SW_MAX}	120	V
SDX/EN Pin Voltage	V _{SDX/EN_MAX}	100	V
FB Pin Voltage	V _{FB_MAX}	V _{IN} + 0.3	V
REF Pin Voltage	V _{REF_MAX}	7	V
L_COMP Pin Voltage	V _{L_COMP_MAX}	7	V
Maximum Junction Temperature	T _{jmax}	150	°C
Storage Temperature Range	T _{stg}	-55 to +150	°C

Caution 1: Operating the IC over the absolute maximum ratings may damage the IC. The damage can either be a short circuit between pins or an open circuit between pins and the internal circuitry. Therefore, it is important to consider circuit protection measures, such as adding a fuse, in case the IC is operated over the absolute maximum ratings.

Caution 2: Should by any chance the maximum junction temperature rating be exceeded the rise in temperature of the chip may result in deterioration of the properties of the chip. In case of exceeding this absolute maximum rating, design a PCB with thermal resistance taken into consideration by increasing board size and copper area so as not to exceed the maximum junction temperature rating.

Thermal Resistance (Note 1)

Parameter	Symbol	Thermal Resistance (Typ)		Unit
		1s ^(Note 3)	2s2p ^(Note 4)	
HSO8				
Junction to Ambient	θ _{JA}	265.1	66.1	°C/W
Junction to Top Characterization Parameter ^(Note 2)	Ψ _{JT}	17	9	°C/W
HTSOP-J8				
Junction to Ambient	θ _{JA}	206.4	45.2	°C/W
Junction to Top Characterization Parameter ^(Note 2)	Ψ _{JT}	21	13	°C/W

(Note 1) Based on JE5D51-2A (Still-Air).

(Note 2) The thermal characterization parameter to report the difference between junction temperature and the temperature at the top center of the outside surface of the component package.

(Note 3) Using a PCB board based on JE5D51-3.

(Note 4) Using a PCB board based on JE5D51-5, 7.

Layer Number of Measurement Board	Material	Board Size
Single	FR-4	114.3 mm x 76.2 mm x 1.57 mmt

Top	
Copper Pattern	Thickness
Footprints and Traces	70 μm

Layer Number of Measurement Board	Material	Board Size	Thermal Via ^(Note 5)	
			Pitch	Diameter
4 Layers	FR-4	114.3 mm x 76.2 mm x 1.6 mmt	1.20 mm	Φ0.30 mm

Top		2 Internal Layers		Bottom	
Copper Pattern	Thickness	Copper Pattern	Thickness	Copper Pattern	Thickness
Footprints and Traces	70 μm	74.2 mm x 74.2 mm	35 μm	74.2 mm x 74.2 mm	70 μm

(Note 5) This thermal via connects with the copper pattern of all layers.

Recommended Operating Conditions

Parameter	Symbol	Min	Typ	Max	Unit	Conditions
Operation Power Supply Voltage Range 1	V _{IN}	8	48	80	V	The VIN pin voltage
Operation Power Supply Voltage Range 2	V _{SW}	-	-	110	V	The SW pin voltage
Operation Power Supply Voltage Range 3	V _{L_COMP_MAX2}	-	-	0.5	V	The L_COMP pin voltage
Operation Temperature	T _{opr}	-40	-	+125	°C	

Electrical Characteristics(Unless otherwise specified $V_{IN} = 48\text{ V}$, $V_{SDX/EN} = 2.5\text{ V}$, $T_a = 25\text{ }^\circ\text{C}$)

Parameter	Symbol	Min	Typ	Max	Unit	Conditions
Power Supply Block						
Current at Shutdown	I_{ST}	-	0	10	μA	$V_{SDX/EN} = 0\text{ V}$
Current at Switching Operation	I_{CC}	-	2.8	6.0	mA	$V_{REF} = 0.85\text{ V}$ (At PFM operation)
UVLO Detection Voltage 1	V_{UVLO1}	4.1	5.0	6.0	V	At V_{IN} falling
UVLO Detection Voltage 2	V_{UVLO2}	-	5.2	-	V	At V_{IN} rising
UVLO Voltage Hysteresis	V_{UVLO_HYS}	0.1	0.2	0.3	V	
Shutdown and Enable Control Block						
Shutdown Voltage	V_{SDX}	-	-	0.3	V	
Enable Voltage 1	V_{EN1}	1.7	2.0	2.3	V	At $V_{SDX/EN}$ rising
Enable Voltage 2	V_{EN2}	-	1.8	-	V	At $V_{SDX/EN}$ falling
Enable Voltage Hysteresis	V_{EN_HYS}	0.1	0.2	0.3	V	
SDX/EN Pin Inflow Current	$I_{SDX/EN}$	1.6	2.5	3.9	μA	
SDX/EN Pin Clamp Voltage	V_{CLPEN}	-	5.3	-	V	
SDX/EN Pin Pull-down Resistance 1	$R_{SDX/EN1}$	-	815	-	$\text{k}\Omega$	
SDX/EN Pin Pull-down Resistance 2	$R_{SDX/EN2}$	-	190	-	$\text{k}\Omega$	
Reference Voltage Block						
Reference Voltage	V_{INTREF}	0.768	0.780	0.792	V	
REF Pin Current	I_{REF}	-	390	-	μA	
Switching Block						
On Resistance	R_{ON}	0.25	0.50	1.00	Ω	Between the SW and PGND pins
Over Current Detection Current	I_{LIMIT}	1.40	1.75	2.10	A	
Switching Frequency	f_{SW}	-	400	-	kHz	At PWM operation (Duty = 40 %)
On Time	t_{ON}	0.75	1.00	1.25	μs	At PWM operation (Duty = 40 %)
Minimum On Time	t_{ON_MIN}	260	350	440	ns	
Minimum Off Time	t_{OFF_MIN}	335	450	565	ns	
Maximum Off Time	t_{OFF_MAX}	14	20	26	μs	
Soft Start Time	t_{SS}	1.2	2.5	5.0	ms	From rise-up to $V_{REF} \times 90\%$
Maximum Duty	D_{MAX}	-	50	-	%	
Minimum Duty	D_{MIN}	-	20	-	%	
Protection Function Block						
Short Protection Detection Voltage	V_{SCP}	-	0.50	-	V	
Over Voltage Protection Detection Voltage	V_{OVP}	-	0.95	-	V	
Battery Short Protection Detection Voltage	V_{BSP}	-	2.0	-	V	
Restart Time	$t_{RESTART}$	-	2.0	-	ms	
Over Current Protection Mask Time	t_{MASK1}	-	280	-	ns	
Short and Over Voltage Protection Mask Time	t_{MASK2}	-	400	-	ns	
Short Protection Mask Time at Startup	t_{MASK3}	-	600	-	μs	
Load Compensation Block						
Internal Resistor at L_COMP Pin	$R_{INTCOMP}$	-	50	-	$\text{k}\Omega$	
Compressor Magnification in Current Monitor	K	-	0.004	-	%	

Typical Performance Curves

(Reference Data)

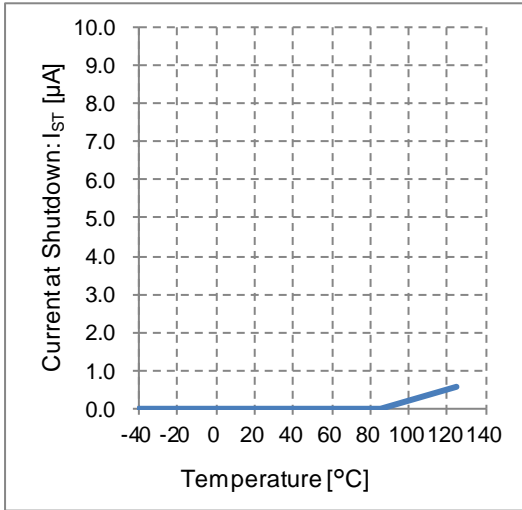

Figure 8. Current at Shutdown vs Temperature

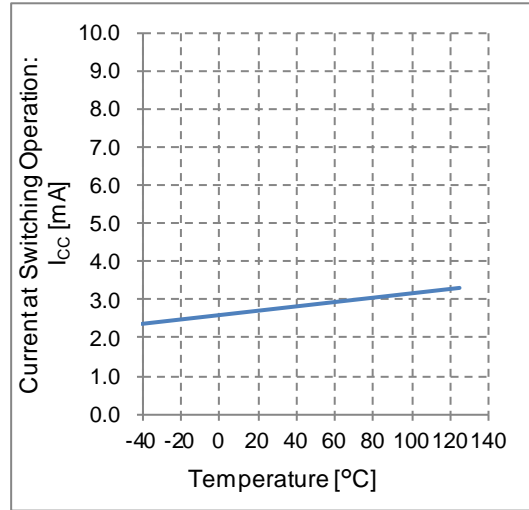

Figure 9. Current at Switching Operation vs Temperature

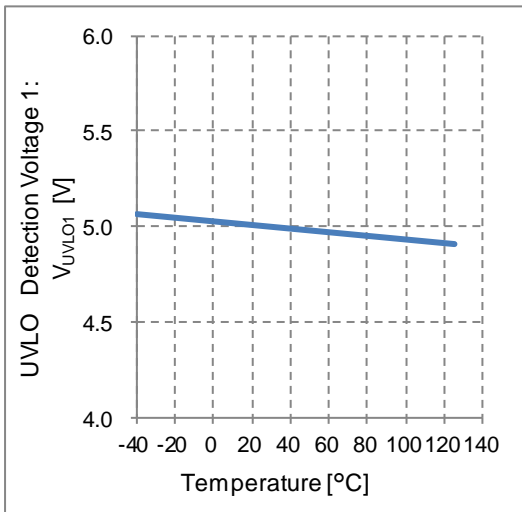

Figure 10. UVLO Detection Voltage 1 vs Temperature

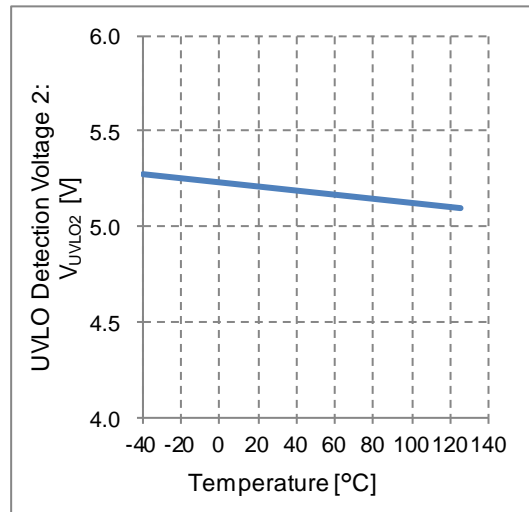

Figure 11. UVLO Detection Voltage 2 vs Temperature

Typical Performance Curves – continued

(Reference Data)

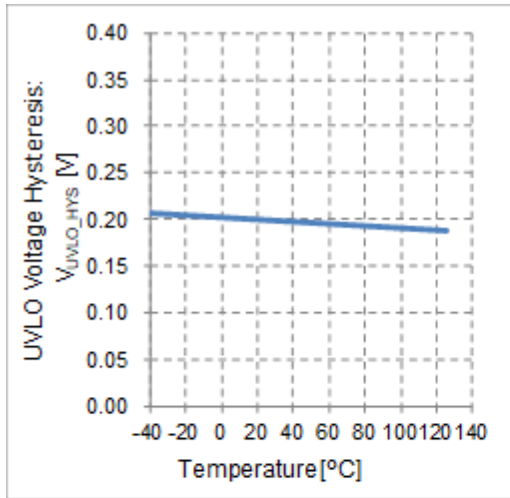

Figure 12. UVLO Voltage Hysteresis vs Temperature

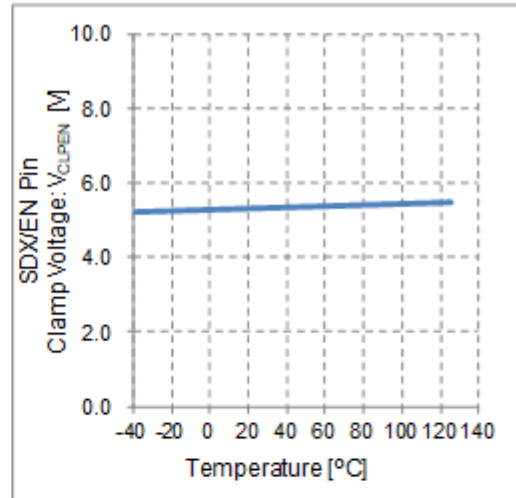

Figure 13. SDX/EN Pin Clamp Voltage vs Temperature

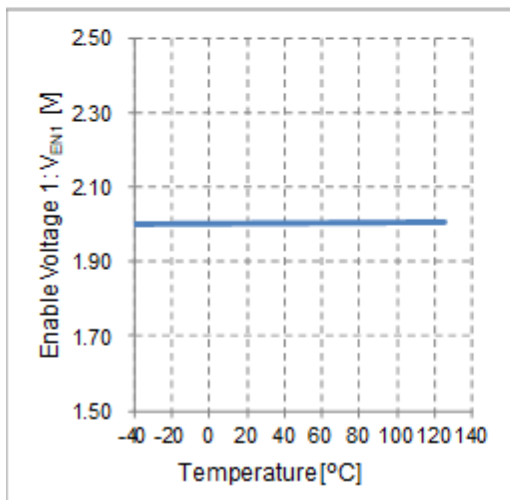

Figure 14. Enable Voltage 1 vs Temperature

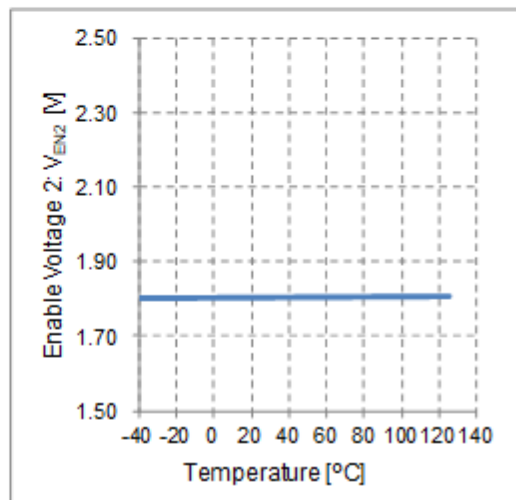

Figure 15. Enable Voltage 2 vs Temperature

Typical Performance Curves – continued

(Reference Data)

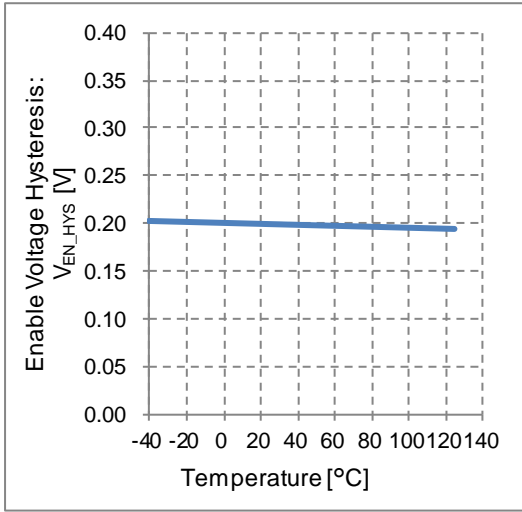

Figure 16. Enable Voltage Hysteresis vs Temperature

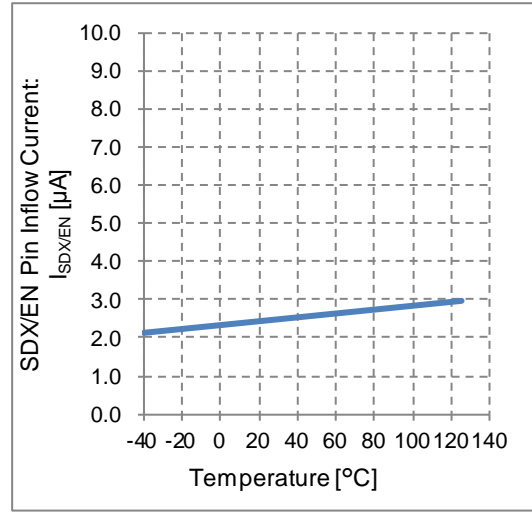

Figure 17. SDX/EN Pin Inflow Current vs Temperature

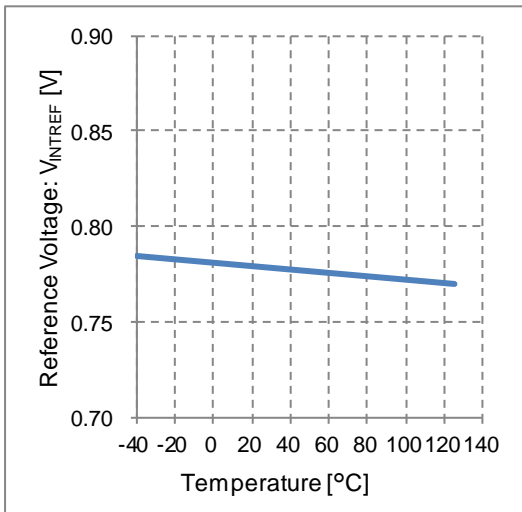

Figure 18. Reference Voltage vs Temperature

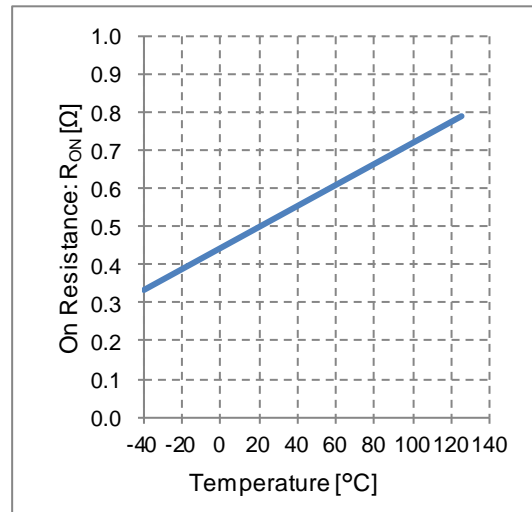

Figure 19. On Resistance vs Temperature

Typical Performance Curves – continued

(Reference Data)

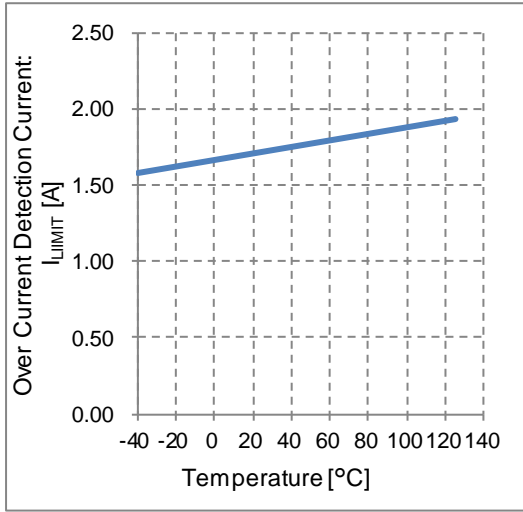

Figure 20. Over Current Detection Current vs Temperature

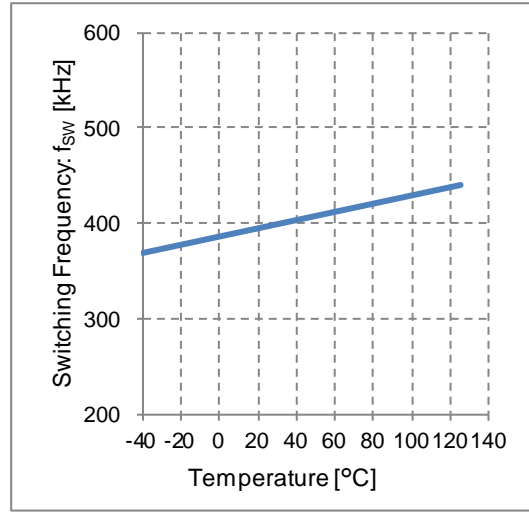

Figure 21. Switching Frequency vs Temperature

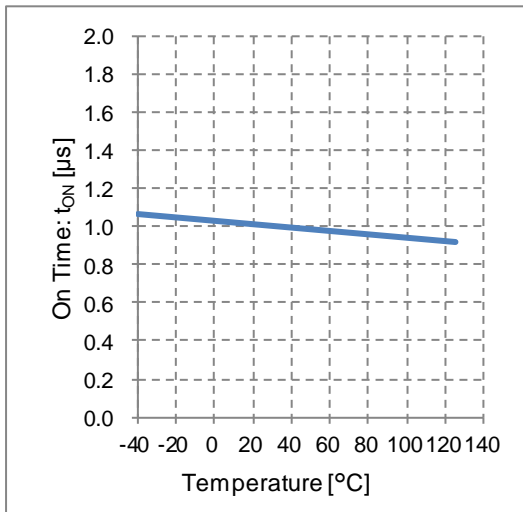

Figure 22. On Time vs Temperature

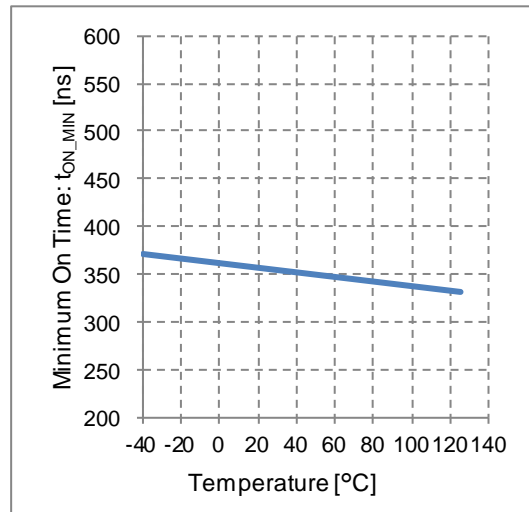

Figure 23. Minimum On Time vs Temperature

Typical Performance Curves – continued

(Reference Data)

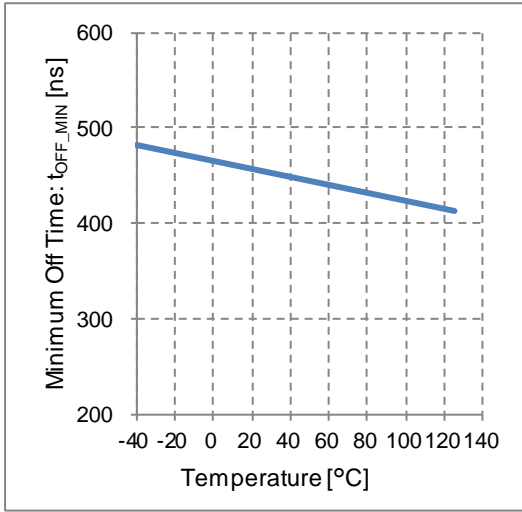

Figure 24. Minimum Off Time vs Temperature

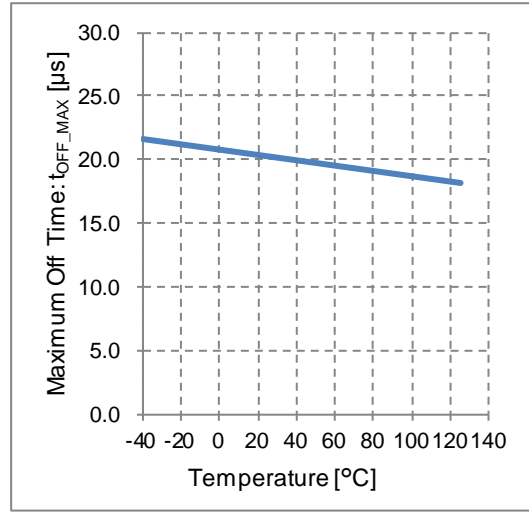

Figure 25. Maximum Off Time vs Temperature

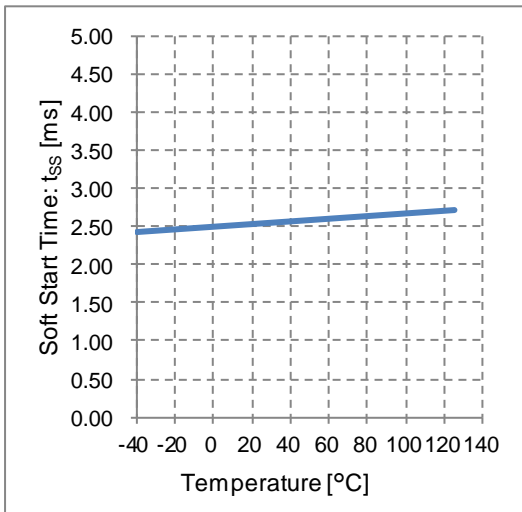

Figure 26. Soft Start Time vs Temperature

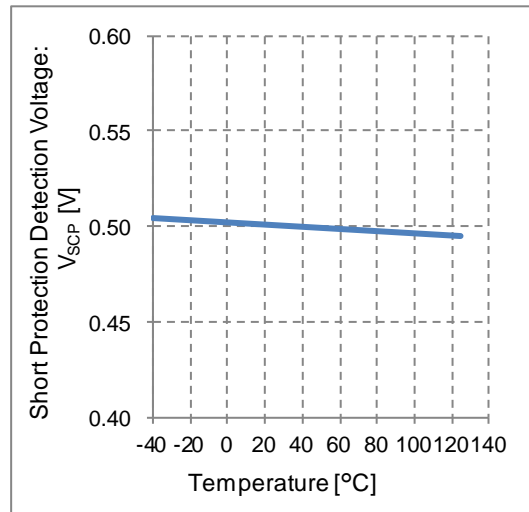

Figure 27. Short Protection Detection Voltage vs Temperature

Typical Performance Curves – continued

(Reference Data)

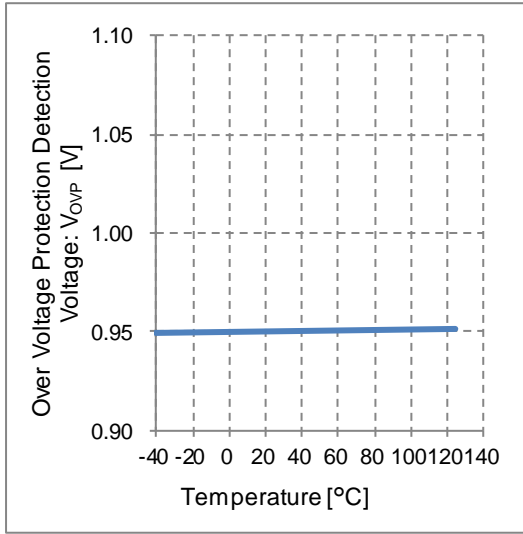

Figure 28. Over Voltage Protection Detection Voltage vs Temperature

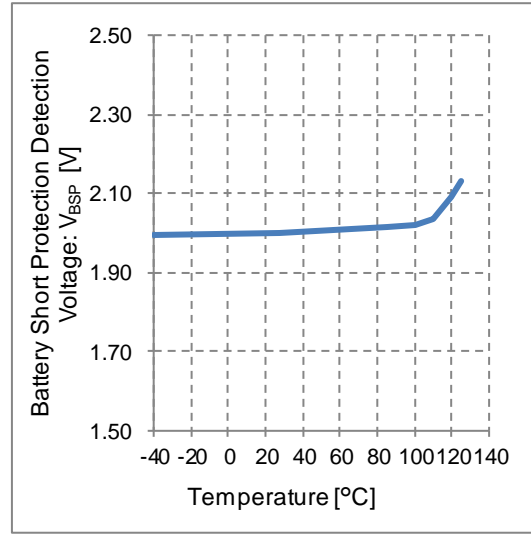

Figure 29. Battery Short Protection Detection Voltage vs Temperature

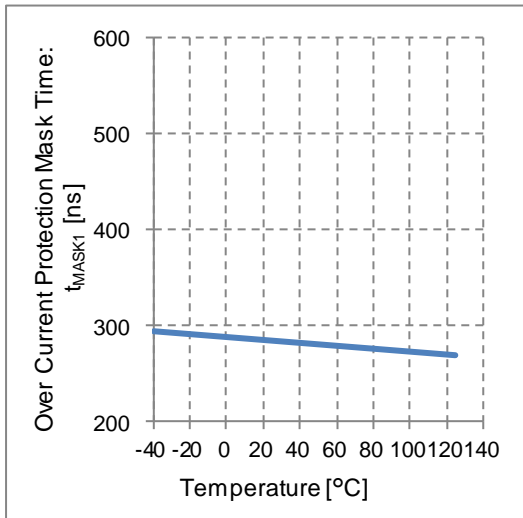

Figure 30. Over Current Protection Mask Time vs Temperature

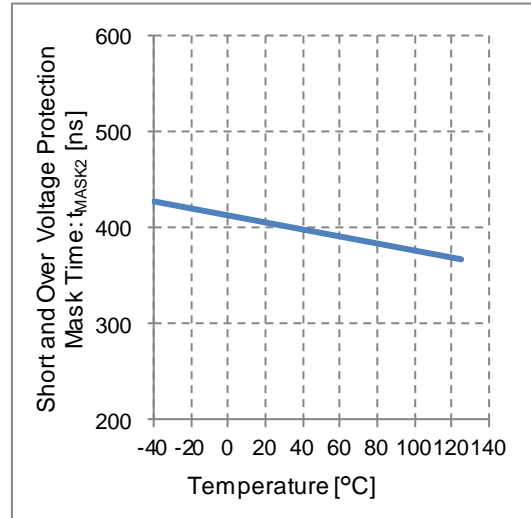

Figure 31. Short and Over Voltage Protection Mask Time vs Temperature

Typical Performance Curves – continued

(Reference Data)

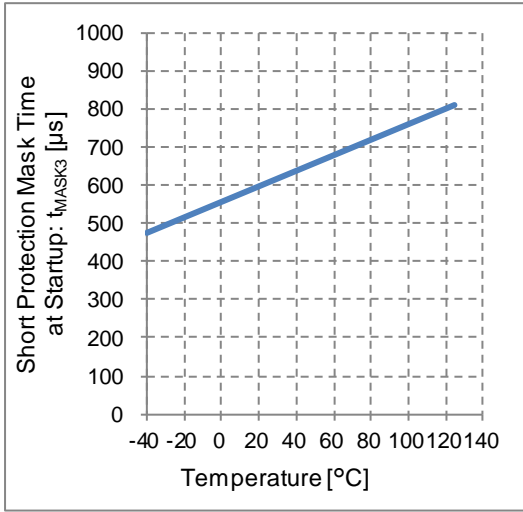

Figure 32. Short Protection Mask Time at Startup vs Temperature

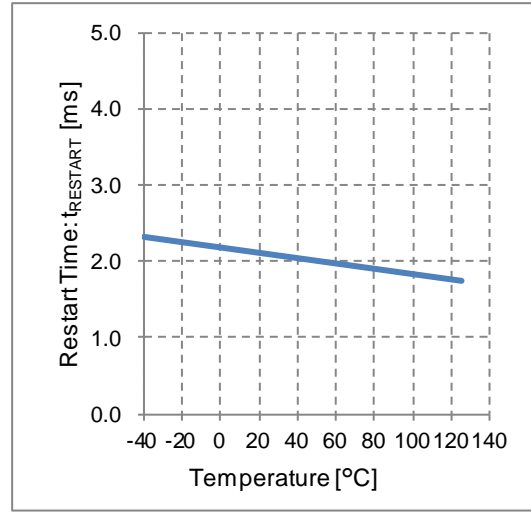

Figure 33. Restart Time vs Temperature

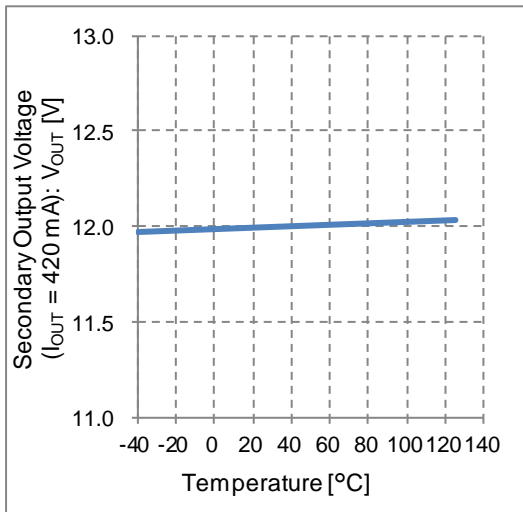

Figure 34. Secondary Output Voltage vs Temperature (I_{OUT} = 420 mA)

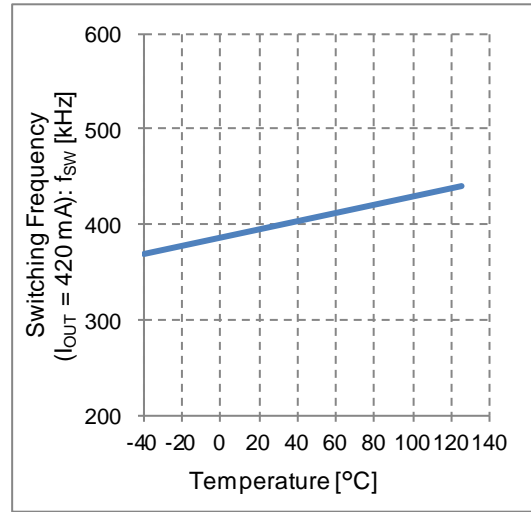

Figure 35. Switching Frequency vs Temperature (I_{OUT} = 420 mA)

Typical Performance Curves – continued

(Reference Data)

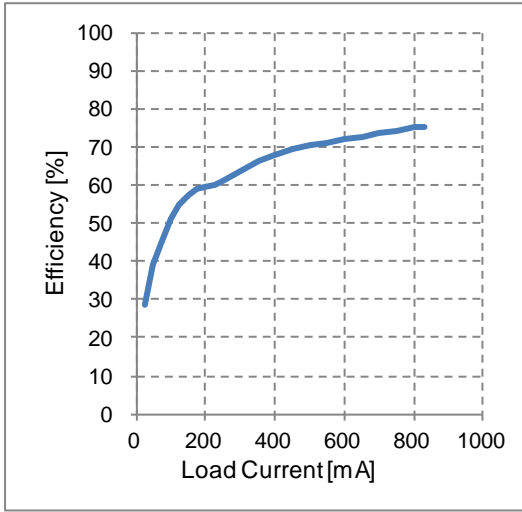

Figure 36. Efficiency vs Load Current

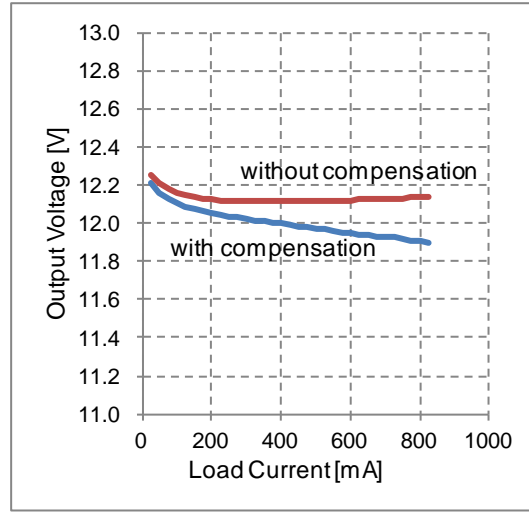

Figure 37. Output Voltage vs Load Current

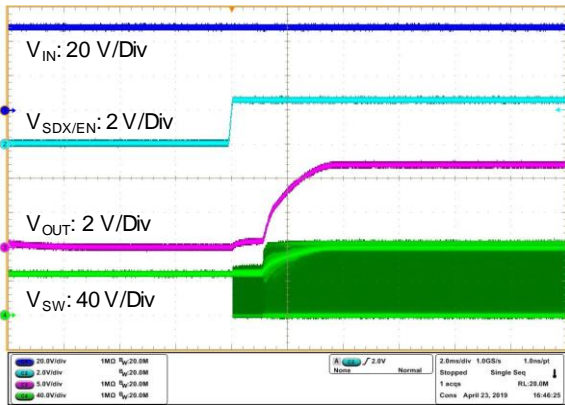

Figure 38. Startup Waveform (The SDX/EN Pin Control)

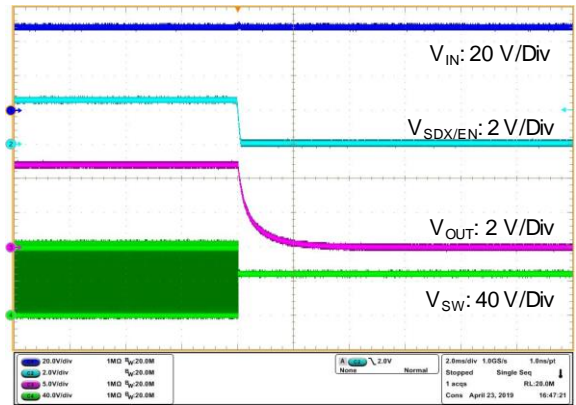

Figure 39. Shutdown Waveform (The SDX/EN Pin Control)

Typical Performance Curves – continued

(Reference Data)

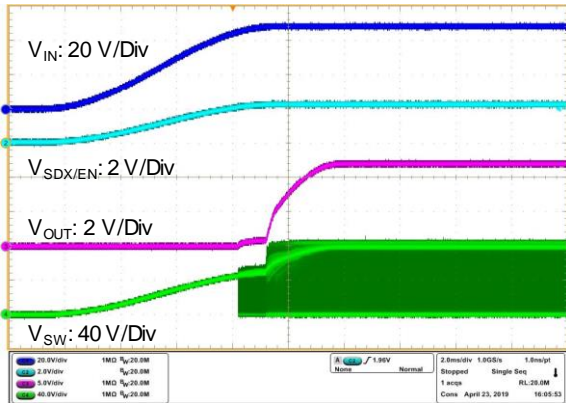

Figure 40. Startup Waveform (The VIN Pin Control)

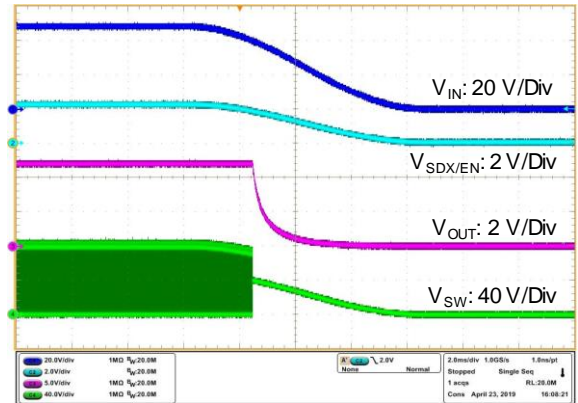

Figure 41. Shutdown Waveform (The VIN Pin Control)

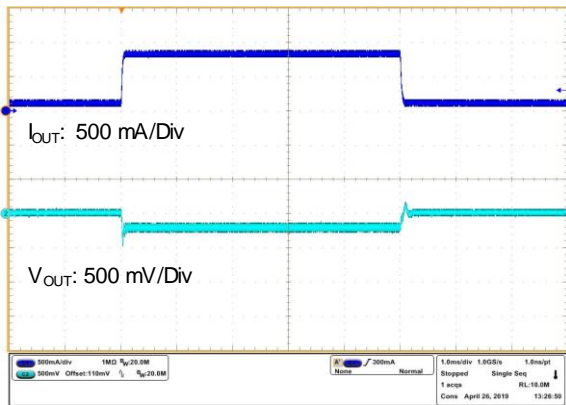

Figure 42. Load Transient Response
(I_{OUT} = 0.1 A to 0.83 A)

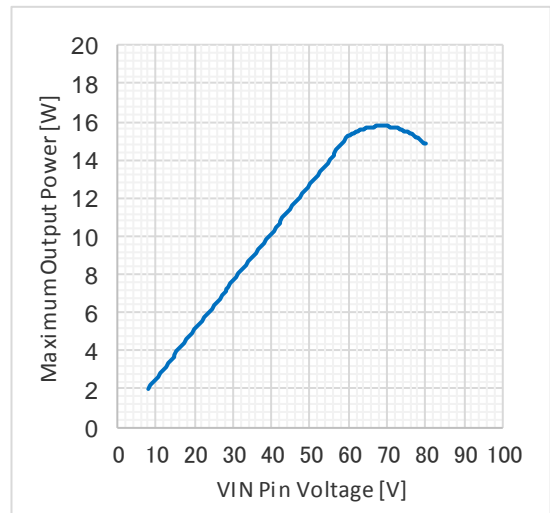

Figure 43. Maximum Output Power vs VIN Pin Voltage

Application Examples

1 Output Voltage

When the internal switching MOSFET is off, the SW pin voltage becomes higher than the VIN pin voltage. The secondary output voltage is calculated by the primary flyback voltage, which is described by the difference between this SW pin voltage and VIN pin voltage. The SW pin voltage at turn off is calculated by the formula below.

$$V_{SW} = V_{IN} + \frac{N_P}{N_S} \times (V_{OUT} + V_F + I_S \times ESR) \quad [V]$$

Where:

V_{SW} is the SW pin voltage.

V_{IN} is the VIN pin voltage.

N_P is the number of winding at the primary transformer.

N_S is the number of winding at the secondary transformer.

V_{OUT} is the output voltage.

V_F is the forward voltage of the secondary output diode.

I_S is the secondary transformer current.

ESR is the secondary total impedance (secondary transformer winding resistance and PCB impedance).

The external resistor R_{FB} between the FB and SW pins converts the primary flyback voltage into the FB pin inflow current I_{RFB} . The FB pin inflow current I_{RFB} is calculated by the formula below because the FB pin voltage is nearly equal to the VIN pin voltage by the IC's internal circuit.

$$\begin{aligned} I_{RFB} &= \frac{V_{SW} - V_{FB}}{R_{FB}} \\ &= \frac{V_{IN} + \frac{N_P}{N_S} \times (V_{OUT} + V_F + I_S \times ESR) - V_{FB}}{R_{FB}} \\ &= \frac{\frac{N_P}{N_S} \times (V_{OUT} + V_F + I_S \times ESR)}{R_{FB}} \quad [A] \end{aligned}$$

Where:

I_{RFB} is the FB pin inflow current.

V_{FB} is the FB pin voltage.

R_{FB} is the external resistor between the FB and SW pins.

Furthermore, the REF pin voltage is calculated by the formula below because the FB pin inflow current flows into the external resistor R_{REF} between the REF and AGND pins.

$$V_{REF} = \frac{R_{REF}}{R_{FB}} \times \frac{N_P}{N_S} \times (V_{OUT} + V_F + I_S \times ESR) \quad [V]$$

Where:

V_{REF} is the REF pin voltage.

R_{REF} is the external resistor between the REF and AGND pins.

The resistor R_{REF} is necessary to be set as the current flowing in the REF pin becomes I_{REF} when the REF pin voltage is equal to V_{INTREF} . This IC's internal circuit is designed as $R_{REF} = 2 \text{ k}\Omega$ according to the formula below.

$$R_{REF} = \frac{V_{INTREF}}{I_{REF}} \quad [\Omega]$$

Where:

V_{INTREF} is the REF pin voltage.

1 Output Voltage – continued

The REF pin voltage is input to the comparator with the reference voltage in the IC. By the internal circuit, the REF pin voltage becomes equal to the reference voltage. Therefore, the output voltage and the REF pin voltage is calculated by the formula below.

$$V_{OUT} = \frac{R_{FB}}{R_{REF}} \times \frac{N_S}{N_P} \times V_{REF} - V_F - I_S \times ESR \quad [V]$$

The output voltage is set by the number of winding ratio of the primary and secondary transformer and the resistance ratio of R_{FB} and R_{REF} . In addition, V_F and ESR is factor of the error in the output voltage. According to the relational expression in above, the external resistor between the FB and SW pins R_{FB} is calculated by the formula below.

$$R_{FB} = \frac{R_{REF}}{V_{REF}} \times \frac{N_P}{N_S} \times (V_{OUT} + V_F + I_S \times ESR) \quad [\Omega]$$

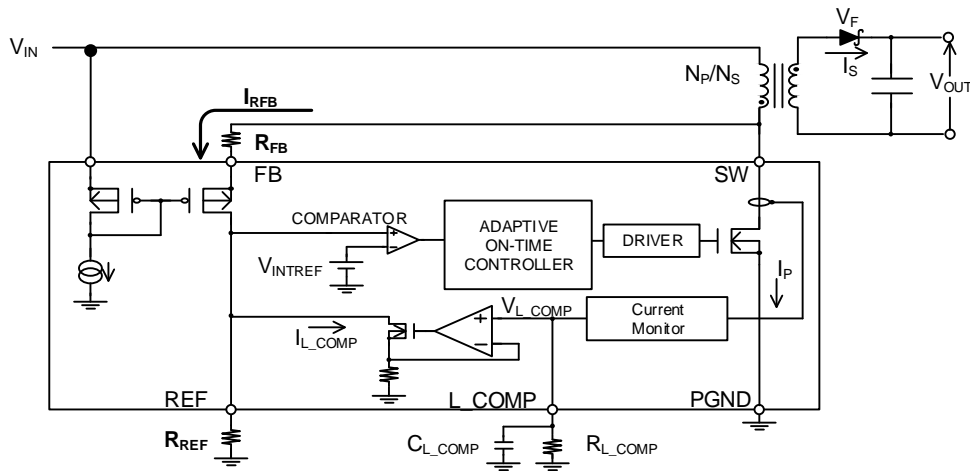

Figure 44. Control Block Diagram

Application Examples – continued

2 Transformer

2.1 Number of Winding Ratio

The number of winding ratio is the parameter with which the output voltage, maximum output electric power, duty and the SW pin voltage is set.

The duty of flyback converter is calculated by the formula below.

$$Duty = \frac{\frac{N_P}{N_S} \times (V_{OUT} + V_F)}{V_{IN} + \frac{N_P}{N_S} \times (V_{OUT} + V_F)} \quad [\%]$$

Where:

N_P is the number of winding at the primary transformer.

N_S is the number of winding at the secondary transformer.

V_{OUT} is the output voltage.

V_F is the forward voltage of the secondary output diode.

V_{IN} is the VIN pin voltage.

The feedback voltage is monitored at the SW pin. In addition, it is necessary to set the duty to D_{MAX} or less for the stable control. By the restriction of the minimum on time, the minimum duty is determined to D_{MIN} and the number of winding ratio has to meet the requirements below.

$$\frac{D_{MIN}}{1 - D_{MIN}} \times \frac{V_{IN}}{V_{OUT} + V_F} < \frac{N_P}{N_S} < \frac{V_{IN}}{V_{OUT} + V_F}$$

Where:

D_{MIN} is the minimum duty.

2 Transformer – continued

2.2 Primary Inductance

The right half plane zero point occurs in the feedback group of flyback converter. The phase delays 90 ° by this, it is necessary to set the right half plane zero frequency f_{RHP_ZERO} to the switching frequency f_{SW} or less. The right half plane zero frequency f_{RHP_ZERO} is calculated by the formula below.

$$f_{RHP_ZERO} = \frac{\left(\frac{N_P}{N_S}\right)^2 \times \left\{ \frac{V_{IN}}{V_{IN} + \frac{N_P}{N_S} \times (V_{OUT} + V_F)} \right\}^2 \times R_{OUT}}{2\pi \times \frac{\frac{N_P}{N_S} \times (V_{OUT} + V_F)}{V_{IN} + \frac{N_P}{N_S} \times (V_{OUT} + V_F)} \times L_P} \quad [\text{Hz}]$$

Where:

f_{RHP_ZERO} is the right half plane zero frequency.

N_P is the number of winding at the primary transformer.

N_S is the number of winding at the secondary transformer.

V_{IN} is the VIN pin voltage.

V_{OUT} is the output voltage.

V_F is the forward voltage of the secondary output diode.

R_{OUT} is the load resistance.

L_P is the primary inductance.

For the insurance of stability, the right half plane zero frequency f_{RHP_ZERO} has to be set to more than one quarter of the switching frequency f_{SW} . From this, the condition below is required.

$$f_{RHP_ZERO} > \frac{1}{4} \times f_{SW}$$

$$L_P < \frac{2 \times \text{Duty} \times V_{IN}^2}{(V_{OUT} + V_F) \times I_{OUT_MAX} \times \pi \times f_{SW}} \quad [\text{H}]$$

Where:

f_{SW} is the switching frequency.

I_{OUT_MAX} is the maximum value of the output current.

2.2 Primary Inductance – continued

The minimum value of primary inductance can be found by the relation of in/output electric power. If the L_p becomes lower, the peak current of primary transformer becomes higher. Because the necessary output voltage cannot be obtained if the peak current value becomes the over current detection current or more, the lower limit of necessary primary inductance value corresponding to maximum load is calculated by the conditional expression below.

$$L_p > \frac{1}{2} \times \frac{V_{IN}^2 \times t_s \times Duty^2 \times \eta}{I_{LIMIT_MIN} \times Duty \times V_{IN} \times \eta - V_{OUT_MAX} \times I_{OUT_MAX}} \quad [H]$$

Where:

t_s is the cycle of switching.

η is the efficiency.

I_{LIMIT_MIN} is the minimum value of over current detection current.

V_{OUT_MAX} is the maximum value of output voltage.

According to the above, the primary inductance is necessary to meet the requirements below.

$$\frac{1}{2} \times \frac{V_{IN}^2 \times t_s \times Duty^2 \times \eta}{I_{LIMIT_MIN} \times Duty \times V_{IN} \times \eta - V_{OUT_MAX} \times I_{OUT_MAX}}$$

$$< L_p < \frac{2 \times Duty \times V_{IN}^2}{(V_{OUT} + V_F) \times I_{OUT_MAX} \times \pi \times f_{SW}} \quad [H]$$

2 Transformer – continued

2.3 Leak Inductance

The leak inductance of transformer causes the ringing at the SW pin at the moment the internal switching MOSFET is turned off. Insert the snubber circuit not to exceed the absolute maximum rating of the SW pin voltage. It is necessary to settle down within t_{MASK2} for the prevention of the error in the secondary output voltage. In addition, it is important to consider that it is not exceeded the rating voltage of secondary output diode at the moment the internal switching MOSFET is turned on.

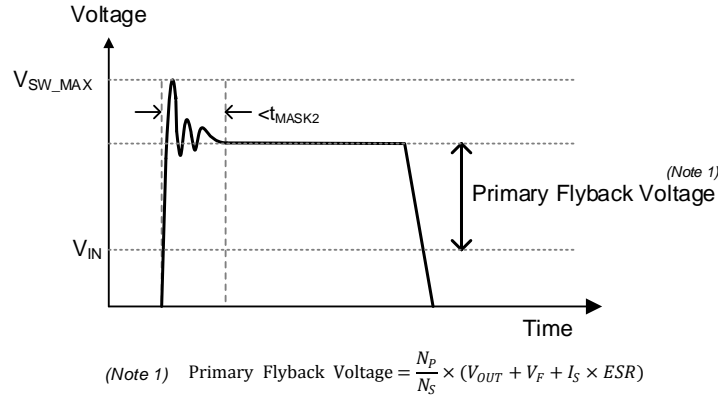

Figure 45. Leak Inductance

2.4 Winding Resistance

The primary winding resistance lowers the efficiency of electricity and the secondary winding resistance lowers the output voltage as well as it. According to them, it is recommended to use the small winding resistance transformer.

2.5 Saturated Current

Because the core of transformer saturates if the primary transformer current exceeds the rating saturated current, the energy does not transmit to the secondary side. The primary transformer current increases rapidly because the inductance value drops if the core saturates. Set the primary transformer current to less than the rating saturated current.

3 Output Capacitor

It is necessary to select the proper secondary output capacitor for the stable operation. Refer to the indication of the capacitor and select the appropriate capacitor.

$$C_{OUT} = 1.6 \times 10^{-9} \times \frac{1}{L_P} \times \left(\frac{N_P}{N_S} \times Duty \right)^2 \quad [F]$$

Where:

C_{OUT} is the value of output capacitor.

L_P is the primary inductance.

N_P is the number of winding at the primary transformer.

N_S is the number of winding at the secondary transformer.

In addition, it is necessary to rise up within t_{SS} for the secondary output voltage. Therefore, also consider the condition below to select the output capacitor. The startup error may occur because the over current protection operates by the plunging current at startup if the capacitor value is extremely large.

$$C_{OUT} \leq \frac{1}{2} \times \frac{t_{SS} \times \left\{ \left(I_{LIMIT_MIN} \times \frac{N_P}{N_S} \right) \times (1 - Duty) - I_{OUT_MAX} \right\}}{V_{OUT}} \quad [F]$$

Where:

t_{SS} is the soft start time.

I_{LIMIT_MIN} is the minimum value of over current detection current.

I_{OUT_MAX} is the maximum value of output current.

V_{OUT} is the output voltage.

Application Examples – continued

4 Input Capacitor

Use the ceramic capacitor for the input capacitor and locate the input capacitor as near as possible to the VIN pin. The pattern of board and location of capacitor may occur the errors. It is necessary to set the value of input capacitor so that the ripple voltage of the VIN pin becomes 4 % or less of the VIN pin voltage. Also, consider in the load fluctuation and startup.

5 Secondary Output Diode

It is recommended to use the schottky barrier diode whose forward voltage of the secondary output diode V_F is small because the V_F becomes the factor of error in the output voltage. Select the secondary output diode so that the forward current does not exceed the rating. The reverse voltage occurring at the secondary output diode V_R is calculated by the next formula when the internal switching MOSFET is on.

$$V_R = V_{IN} \times \frac{N_S}{N_P} + V_{OUT} \quad [V]$$

Where:

V_R is the reverse voltage at the secondary output diode.

V_{IN} is the VIN pin voltage.

N_P is the number of winding at the primary transformer.

N_S is the number of winding at the secondary transformer.

V_{OUT} is the output voltage.

Furthermore, the ringing piles up the reverse voltage at the secondary output diode V_R at the moment the internal switching MOSFET is turned on. Set the peak voltage of V_R to less than the rating of secondary output diode.

Application Examples – continued

6 Enable Voltage and Disable Voltage

This IC becomes shutdown status when the SDX/EN pin voltage becomes V_{SDX} or less. At the rise-up of the SDX/EN pin voltage, the IC becomes enable status when the voltage becomes V_{EN1} or more and starts the operation. At the fall, the IC becomes disable status when the voltage becomes V_{EN2} or less. Shown as Figure 45, the SDX/EN pin realizes the enable control with the VIN pin by connecting the circuit divided by the resistor R_1 and R_2 between the VIN and AGND pins to the SDX/EN pin. Remind that the internal clamp element turned on and the inflow current occurs if the SDX/EN pin voltage becomes V_{CLPEN} or more.

6.1 Enable Voltage

The enable voltage at the rise-up of the VIN pin voltage V_{IN_ENABLE} is calculated by the formula below.

$$V_{IN_ENABLE} = V_{EN1} \times \frac{R_1 \times (R_2 + R_{SDX/EN1}) + R_2 \times R_{SDX/EN1}}{R_2 \times R_{SDX/EN1}} \quad [V]$$

Where:

V_{IN_ENABLE} is the enable voltage at the rise-up of the VIN pin voltage.

V_{EN1} is the enable voltage 1.

6.2 Disable Voltage

The disable voltage at the fall of the VIN pin voltage $V_{IN_DISABLE}$ is calculated by the formula below.

$$V_{IN_DISABLE} = V_{EN2} \times \frac{R_1 \times (R_2 + R_{SDX/EN1} + R_{SDX/EN2}) + R_2 \times (R_{SDX/EN1} + R_{SDX/EN2})}{R_2 \times (R_{SDX/EN1} + R_{SDX/EN2})} \quad [V]$$

$V_{IN_DISABLE}$ is the disable voltage at the fall of the VIN pin voltage.

V_{EN2} is the enable voltage 2.

It is necessary to set the duty to D_{MAX} or less and operate in this IC's control method. So set the disable voltage at the fall of the VIN pin voltage $V_{IN_DISABLE}$ to meet the condition below.

$$V_{IN_DISABLE} > \frac{N_P}{N_S} \times (V_{OUT} + V_F) \quad [V]$$

Where:

N_P is the number of winding at the primary transformer.

N_S is the number of winding at the secondary transformer.

V_{OUT} is the output voltage.

V_F is the forward voltage at the secondary output diode.

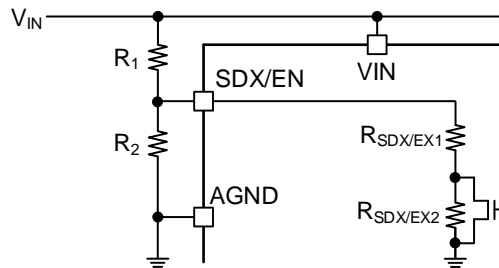

Figure 46. Position of Resistors Connected to the SDX/EN Pin

Application Examples – continued

7 Minimum Load Current

This IC stabilizes the secondary output voltage isolated with the transformer by the primary flyback voltage at the internal switching MOSFET turned off. Therefore, it operates with the minimum on time t_{ON_MIN} and maximum off time t_{OFF_MAX} even if the status is light load. By this operation, the output voltage may rise in the case of the low load current because a little energy is supplied to the secondary output. To prevent the rise of output voltage, secure the minimum load current with adding such as the dummy resistor R_{DUMMY} . The necessary minimum load current I_{OUT_MIN} is calculated by the formula below.

$$I_{OUT_MIN} = \frac{1}{2} \times \frac{(V_{IN} \times t_{ON_MIN})^2}{L_P \times V_{OUT} \times (t_{ON_MIN} + t_{OFF_MAX})} \quad [A]$$

Where:

I_{OUT_MIN} is the minimum output current.

V_{IN} is the VIN pin voltage.

t_{ON_MIN} is the minimum on time.

L_P is the primary inductance.

V_{OUT} is the output voltage.

t_{OFF_MAX} is the maximum off time.

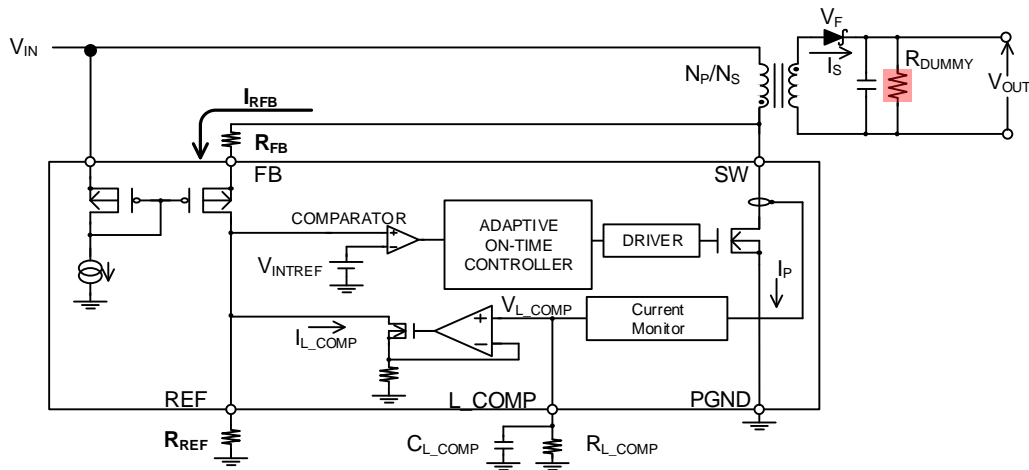

Figure 47. Position of R_{DUMMY}

Application Examples – continued

8 Infection Point of Switching Frequency

This IC realizes the efficiency by fluctuating the switching frequency corresponding to the load current at light load. The load current I_{OUT_fsw} , from which the switching frequency f_{sw} starts to drop, is calculated by the formula below.

$$I_{OUT_fsw} = \frac{1}{2} \times \frac{f_{sw} \times (V_{IN} \times t_{ON_MIN})^2}{L_P \times V_{OUT}} \quad [A]$$

Where:

I_{OUT_fsw} is the load current, from which the switching frequency starts to drop.

f_{sw} is the switching frequency.

V_{IN} is the VIN pin voltage.

t_{ON_MIN} is the minimum on time.

L_P is the primary inductance.

V_{OUT} is the output voltage.

In addition, the switching frequency becomes the minimum switching frequency f_{sw_MIN} at the switching operation with the minimum on time t_{ON_MIN} and maximum off time t_{OFF_MAX} and it is calculated by the formula below.

$$f_{sw_MIN} = \frac{1}{t_{ON_MIN} + t_{OFF_MAX}} \quad [Hz]$$

Where:

f_{sw_MIN} is the minimum switching frequency.

t_{OFF_MAX} is the maximum off time.

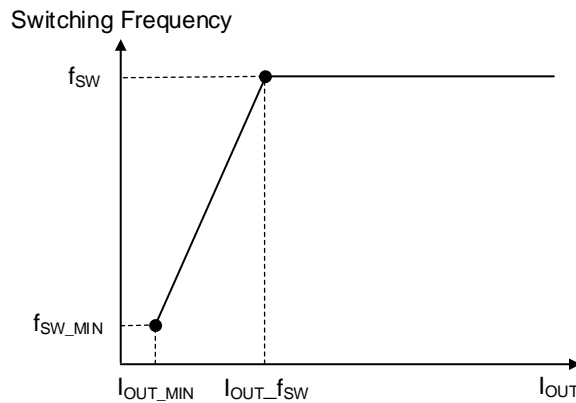

Figure 48. Switching Frequency vs I_{OUT}

Application Examples – continued

9 Load Compensation Function

The load regulation is worsen by V_F and ESR. In the application gotten worse by these factors, it is enable to make the fluctuation of the output voltage caused by the load current alteration small by using the load compensation function. In addition to above, short the L_COMP pin to the GND to invalidate this function.

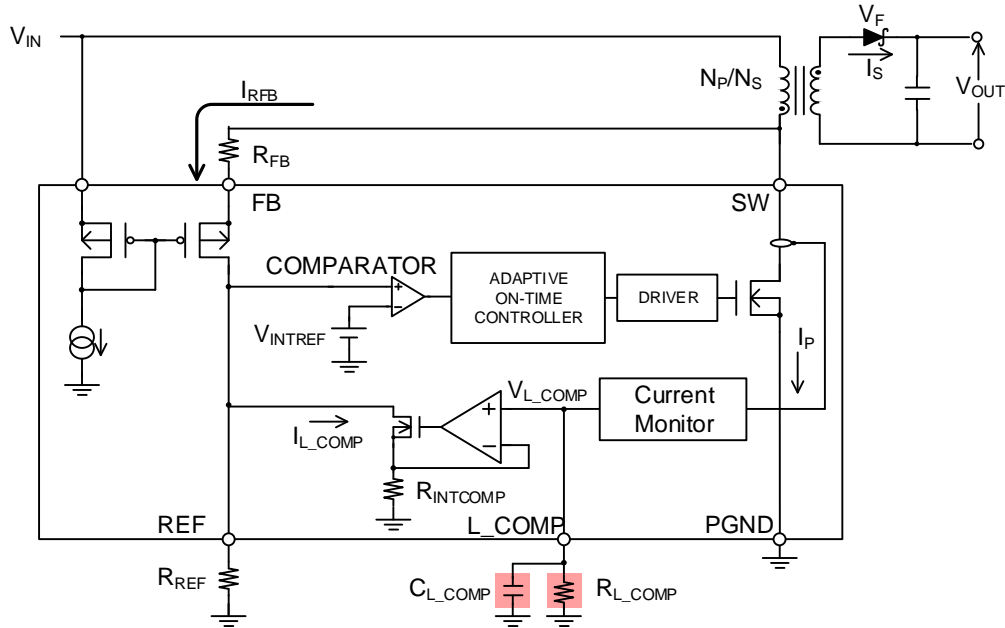

Figure 49. Block Diagram of Load Compensation

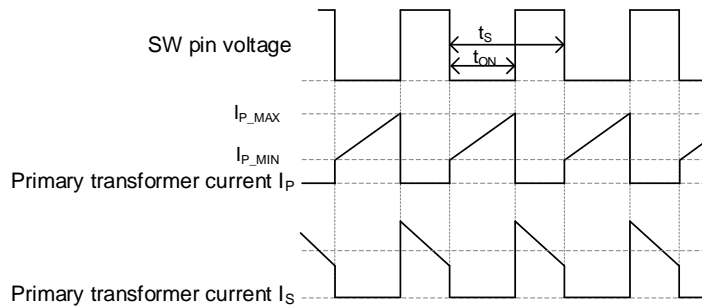

Figure 50. Switching Operation or Continuous Mode

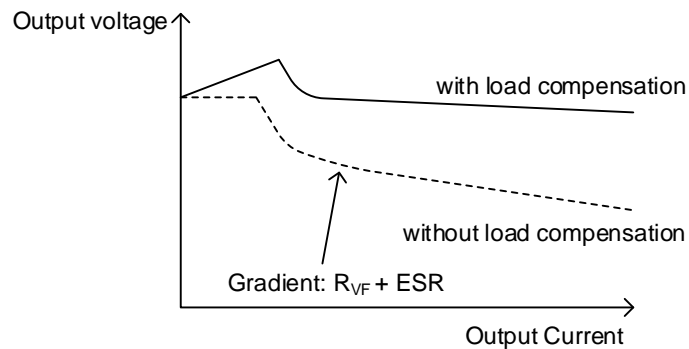

Figure 51. Image of Load Compensation

9 Load Compensation Function – continued

9.1 Setting of Amount of Load Compensation

This function compensates the drop of output voltage V_{OUT} corresponding to the average current of primary transformer current I_P .

The amount of load compensation is adjusted by the external capacitor C_{L_COMP} and external resistor R_{L_COMP} at the L_COMP pin because the primary transformer current I_P and secondary transformer current I_S have the relation of the formula below. The reference value of C_{L_COMP} is 0.1 μ F.

$$I_P = \frac{N_P}{N_S} \times I_S \quad [A]$$

Where:

I_P is the primary transformer current.

N_P is the number of winding at the primary transformer.

N_S is the number of winding at the secondary transformer.

I_S is the secondary transformer current.

9.1.1 Setting of External Resistor at the L_COMP Pin R_{L_COMP}

It is necessary to calculate the L_COMP pin current I_{L_COMP} following the formula below for the setting of the external resistor at the L_COMP pin R_{L_COMP} .

$$I_{L_COMP} = \frac{V_{L_COMP}}{R_{INTCOMP}} \quad [A]$$

Where:

I_{L_COMP} is the L_COMP pin current.

V_{L_COMP} is the L_COMP pin voltage.

$R_{INTCOMP}$ is the internal resistor at the L_COMP pin

V_{L_COMP} mentioned in the formula above is the value converted the current which calculated by $K \times I_P$ flowing from Current Monitor Block to the L_COMP pin by the external resistor at the L_COMP pin R_{L_COMP} . It becomes I_{L_COMP} in the inside and compensates the REF pin current.

It is necessary to meet $V_{L_COMP} \leq 0.5$ V because the operational voltage's upper limit of V_{L_COMP} is restricted by the internal circuit.

In addition, Connect the external capacitor at the L_COMP pin C_{L_COMP} because the rapid fluctuation of I_{L_COMP} may make the V_{L_COMP} unstable.

Than the above, V_{L_COMP} should meet the conditions below.

$$\begin{aligned} V_{L_COMP} &= K \times R_{L_COMP} \times I_{P_AVE} \leq 0.5 \\ &= K \times R_{L_COMP} \times \frac{I_{P_MIN} + I_{P_MAX}}{2} \times \frac{t_{ON}}{t_S} \leq 0.5 \quad [V] \end{aligned}$$

Where:

K is the compressor magnification in Current Monitor Block.

R_{L_COMP} is the external resistor at the L_COMP pin.

I_{P_AVE} is the average value of primary transformer current I_P .

I_{P_MIN} is the minimum value of primary transformer current I_P .

I_{P_MAX} is the maximum value of primary transformer current I_P .

t_S is the switching cycle.

t_{ON} is the on time.

9.1.1 Setting of External Resistor at the L_COMP Pin R_{L_COMP} – continued

By the load compensation function, the feedback current decreases I_{L_COMP} from its original current value flowing at R_{REF} . As the result, the High level of V_{SW} rises for compensating this drop and it compensates the dropped output voltage V_{OUT} .

The output voltage at operating the load compensation function is calculated by the formula below.

$$V_{OUT} = \frac{N_S}{N_P} \times \left(\frac{V_{REF}}{R_{REF}} + I_{L_COMP} \right) \times R_{FB} - V_F - I_{S_AVE} \times ESR \quad [V]$$

Where:

V_{OUT} is the output voltage.

N_S is the number of winding at the secondary transformer.

N_P is the number of winding at the primary transformer.

V_{REF} is the REF pin voltage.

R_{REF} is the external resistor between the REF and AGND pins.

I_{L_COMP} is the L_COMP pin current.

R_{FB} is the external resistor between the FB and SW pins.

V_F is the forward voltage at the secondary output diode.

I_{S_AVE} is the average value of the secondary transformer current I_s .

Reference: The output voltage V_{OUT} at normal operation

$$V_{OUT} = \frac{N_S}{N_P} \times \frac{R_{FB}}{R_{REF}} \times V_{REF} - V_F - I_{S_AVE} \times ESR \quad [V]$$

According to the formula above, it is necessary to establish the next formula to remove the forward voltage at the secondary output diode V_F and ESR by the L_COMP pin current I_{L_COMP} .

$$I_{L_COMP} \times \frac{N_S}{N_P} \times R_{FB} = V_F + I_{S_AVE} \times ESR \quad [A]$$

Next, calculate the R_{L_COMP} by making the linear approximation R_{VF} of the fluctuation of the forward voltage at the secondary output diode corresponding to the secondary transformer current I_s .

$$\frac{K \times R_{L_COMP} \times I_{P_AVE}}{R_{INTCOMP}} \times \frac{N_S}{N_P} \times R_{FB} = I_{S_AVE} \times R_{VF} + I_{S_AVE} \times ESR$$

$$\frac{K \times R_{L_COMP}}{R_{INTCOMP}} \times \left(\frac{N_S}{N_P} \right)^2 \times R_{FB} = (R_{VF} + ESR) \times \frac{1 - Duty}{Duty}$$

Than the above,

$$R_{L_COMP} = R_{INTCOMP} \times \frac{R_{VF} + ESR}{K \times R_{FB}} \times \left(\frac{N_S}{N_P} \right)^2 \times \frac{1 - Duty}{Duty} \quad [\Omega]$$

Where:

K is the compressor magnification in Current Monitor Block.

R_{L_COMP} is the external resistor at the L_COMP pin.

I_{P_AVE} is the average value of primary transformer current I_P .

$R_{INTCOMP}$ is the internal resistor at the L_COMP pin

The values of R_{VF} , ESR, and R_{FB} depend on the operating environment such as use parts and mounting boards. When set the R_{L_COMP} actually, adjust them monitoring the output voltage V_{OUT} in the range of using load current certainly.

I/O Equivalence Circuit

1	AGND	2	SDX/EN	3	L_COMP	4	REF
5	FB	6	PGND	7	SW	8	VIN

Operational Notes

1. Reverse Connection of Power Supply

Connecting the power supply in reverse polarity can damage the IC. Take precautions against reverse polarity when connecting the power supply, such as mounting an external diode between the power supply and the IC's power supply pins.

2. Power Supply Lines

Design the PCB layout pattern to provide low impedance supply lines. Furthermore, connect a capacitor to ground at all power supply pins. Consider the effect of temperature and aging on the capacitance value when using electrolytic capacitors.

3. Ground Voltage

Ensure that no pins are at a voltage below that of the ground pin at any time, even during transient condition.

4. Ground Wiring Pattern

When using both small-signal and large-current ground traces, the two ground traces should be routed separately but connected to a single ground at the reference point of the application board to avoid fluctuations in the small-signal ground caused by large currents. Also ensure that the ground traces of external components do not cause variations on the ground voltage. The ground lines must be as short and thick as possible to reduce line impedance.

5. Recommended Operating Conditions

The function and operation of the IC are guaranteed within the range specified by the recommended operating conditions. The characteristic values are guaranteed only under the conditions of each item specified by the electrical characteristics.

6. Inrush Current

When power is first supplied to the IC, it is possible that the internal logic may be unstable and inrush current may flow instantaneously due to the internal powering sequence and delays, especially if the IC has more than one power supply. Therefore, give special consideration to power coupling capacitance, power wiring, width of ground wiring, and routing of connections.

7. Testing on Application Boards

When testing the IC on an application board, connecting a capacitor directly to a low-impedance output pin may subject the IC to stress. Always discharge capacitors completely after each process or step. The IC's power supply should always be turned off completely before connecting or removing it from the test setup during the inspection process. To prevent damage from static discharge, ground the IC during assembly and use similar precautions during transport and storage.

8. Inter-pin Short and Mounting Errors

Ensure that the direction and position are correct when mounting the IC on the PCB. Incorrect mounting may result in damaging the IC. Avoid nearby pins being shorted to each other especially to ground, power supply and output pin. Inter-pin shorts could be due to many reasons such as metal particles, water droplets (in very humid environment) and unintentional solder bridge deposited in between pins during assembly to name a few.

9. Unused Input Pins

Input pins of an IC are often connected to the gate of a MOS transistor. The gate has extremely high impedance and extremely low capacitance. If left unconnected, the electric field from the outside can easily charge it. The small charge acquired in this way is enough to produce a significant effect on the conduction through the transistor and cause unexpected operation of the IC. So unless otherwise specified, unused input pins should be connected to the power supply or ground line.

Operational Notes – continued

10. Regarding the Input Pin of the IC

This monolithic IC contains P+ isolation and P substrate layers between adjacent elements in order to keep them isolated. P-N junctions are formed at the intersection of the P layers with the N layers of other elements, creating a parasitic diode or transistor. For example (refer to figure below):

When GND > Pin A and GND > Pin B, the P-N junction operates as a parasitic diode.
 When GND > Pin B, the P-N junction operates as a parasitic transistor.

Parasitic diodes inevitably occur in the structure of the IC. The operation of parasitic diodes can result in mutual interference among circuits, operational faults, or physical damage. Therefore, conditions that cause these diodes to operate, such as applying a voltage lower than the GND voltage to an input pin (and thus to the P substrate) should be avoided.

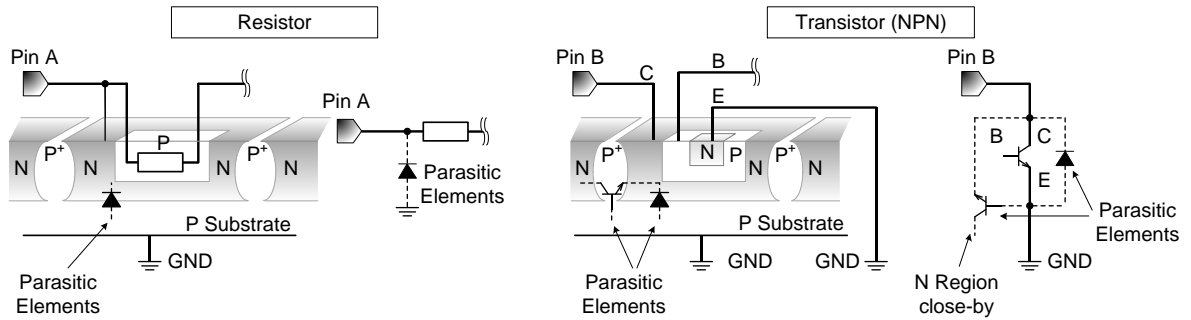

Figure 52. Example of Monolithic IC Structure

11. Ceramic Capacitor

When using a ceramic capacitor, determine a capacitance value considering the change of capacitance with temperature and the decrease in nominal capacitance due to DC bias and others.

12. Thermal Shutdown Circuit (TSD)

This IC has a built-in thermal shutdown circuit that prevents heat damage to the IC. Normal operation should always be within the IC's maximum junction temperature rating. If however the rating is exceeded for a continued period, the junction temperature (Tj) will rise which will activate the TSD circuit that will turn OFF power output pins. When the Tj falls below the TSD threshold, the circuits are automatically restored to normal operation.

Note that the TSD circuit operates in a situation that exceeds the absolute maximum ratings and therefore, under no circumstances, should the TSD circuit be used in a set design or for any purpose other than protecting the IC from heat damage.

13. Over Current Protection Circuit (OCP)

This IC incorporates an integrated overcurrent protection circuit that is activated when the load is shorted. This protection circuit is effective in preventing damage due to sudden and unexpected incidents. However, the IC should not be used in applications characterized by continuous operation or transitioning of the protection circuit.

Ordering Information

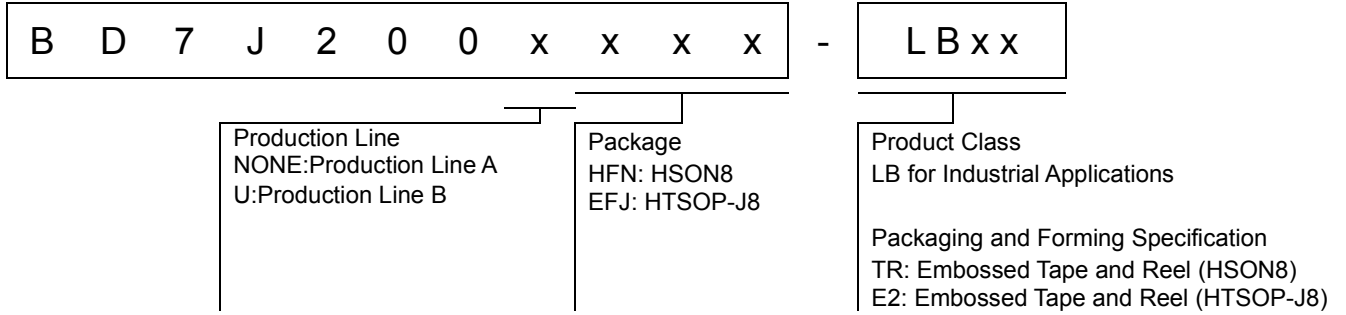

Lineup

Product Name	Part Number Marking	Orderable Part Number	Package	Remarks
BD7J200HFN-LB	D7J200	BD7J200HFN-LBTR	HSON8	-
BD7J200EFJ-LB	D7J200	BD7J200EFJ-LBE2	HTSOP-J8	Production Line A ^(Note 1)
BD7J200UEFJ-LB	U7J200	BD7J200UEFJ-LBE2	HTSOP-J8	Production Line B ^(Note 1)

(Note 1) For the purpose of improving production efficiency, Production Line A and B have a multi-line configuration. Electrical characteristics noted in Datasheet does not differ between Production Line A and B. Production Line B is recommended for new product.

Marking Diagrams

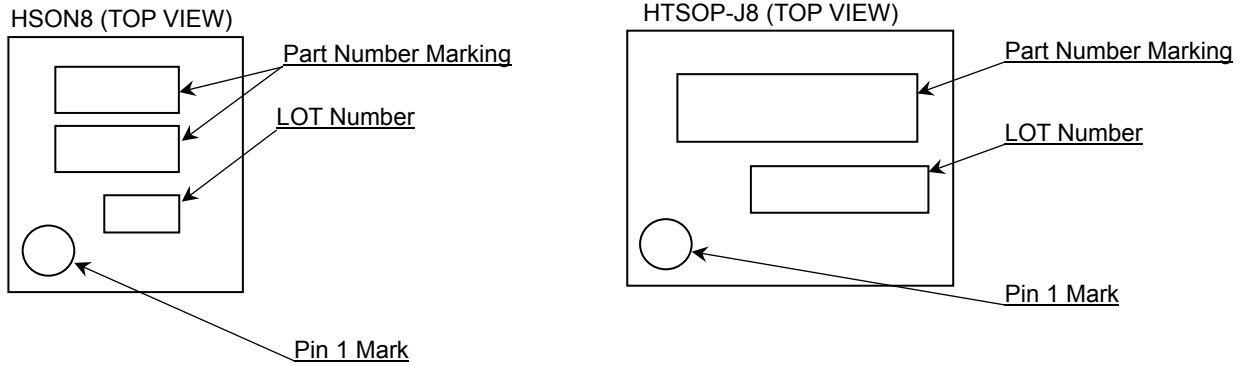

Physical Dimension and Packing Information

Package Name	HSON8
--------------	-------

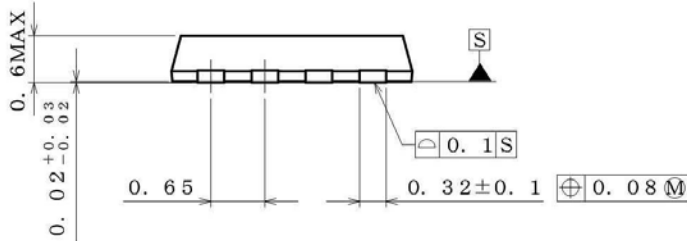
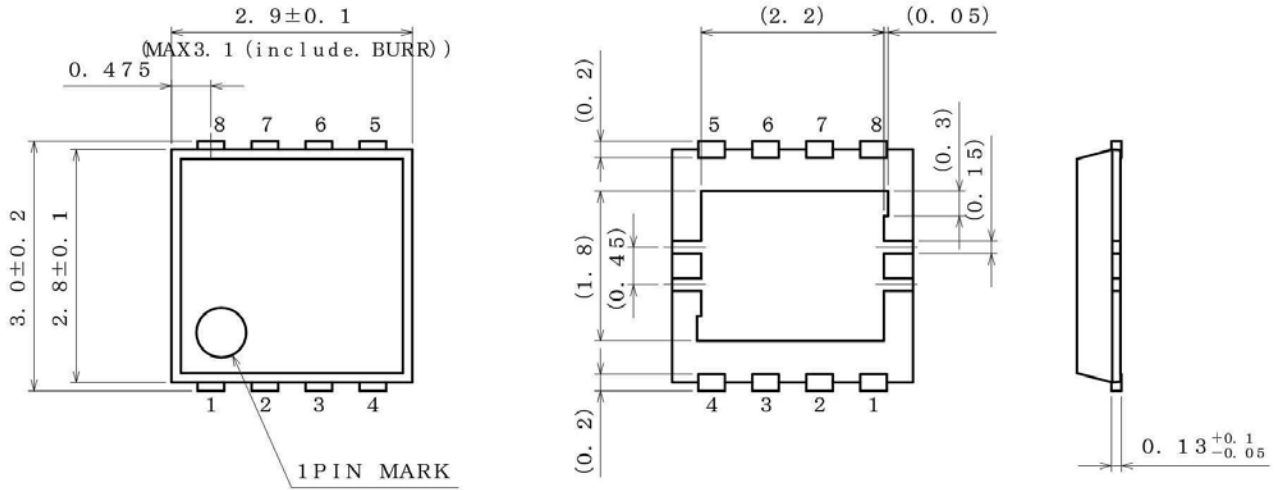

(UNIT : mm)
 PKG : HSON8
 Drawing No. EX163-5002

< Tape and Reel Information >

Tape	Embossed carrier tape
Quantity	3000pcs
Direction of feed	TR [The direction is the 1pin of product is at the upper right when you hold reel on the left hand and you pull out the tape on the right hand]

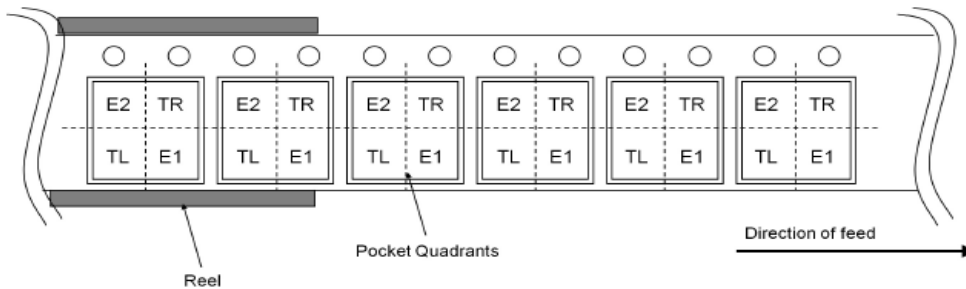

Physical Dimension and Packing Information – continued

Package Name	HTSOP-J8
--------------	----------

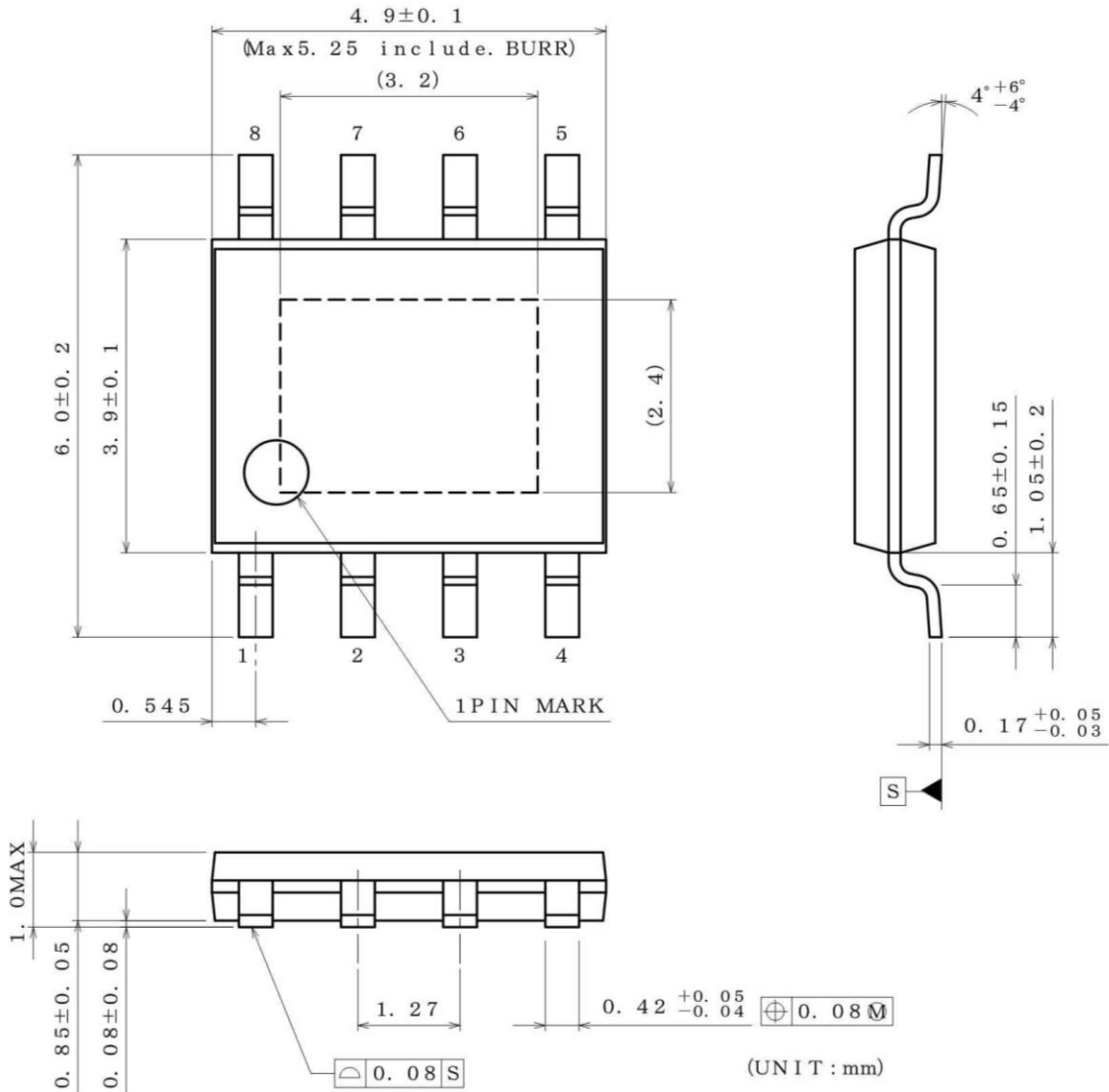

(UNIT : mm)

PKG : HTSOP-J8

Drawing No. EX169-5002-2

< Tape and Reel Information >

Tape	Embossed carrier tape
Quantity	2500pcs
Direction of feed	E2 The direction is the pin 1 of product is at the upper left when you hold reel on the left hand and you pull out the tape on the right hand

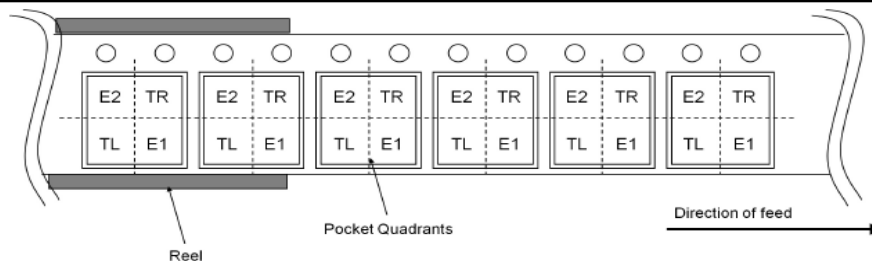

Revision History

Date	Revision	Changes
20.Aug.2019	001	New Release
20.Mar.2023	002	Add BD7J200UEFJ-LB

Notice

Precaution on using ROHM Products

1. If you intend to use our Products in devices requiring extremely high reliability (such as medical equipment ^(Note 1), aircraft/spacecraft, nuclear power controllers, etc.) and whose malfunction or failure may cause loss of human life, bodily injury or serious damage to property ("Specific Applications"), please consult with the ROHM sales representative in advance. Unless otherwise agreed in writing by ROHM in advance, ROHM shall not be in any way responsible or liable for any damages, expenses or losses incurred by you or third parties arising from the use of any ROHM's Products for Specific Applications.

(Note1) Medical Equipment Classification of the Specific Applications

JAPAN	USA	EU	CHINA
CLASS III	CLASS III	CLASS II b	CLASS III
CLASS IV		CLASS III	

2. ROHM designs and manufactures its Products subject to strict quality control system. However, semiconductor products can fail or malfunction at a certain rate. Please be sure to implement, at your own responsibilities, adequate safety measures including but not limited to fail-safe design against the physical injury, damage to any property, which a failure or malfunction of our Products may cause. The following are examples of safety measures:
 - [a] Installation of protection circuits or other protective devices to improve system safety
 - [b] Installation of redundant circuits to reduce the impact of single or multiple circuit failure
3. Our Products are not designed under any special or extraordinary environments or conditions, as exemplified below. Accordingly, ROHM shall not be in any way responsible or liable for any damages, expenses or losses arising from the use of any ROHM's Products under any special or extraordinary environments or conditions. If you intend to use our Products under any special or extraordinary environments or conditions (as exemplified below), your independent verification and confirmation of product performance, reliability, etc, prior to use, must be necessary:
 - [a] Use of our Products in any types of liquid, including water, oils, chemicals, and organic solvents
 - [b] Use of our Products outdoors or in places where the Products are exposed to direct sunlight or dust
 - [c] Use of our Products in places where the Products are exposed to sea wind or corrosive gases, including Cl₂, H₂S, NH₃, SO₂, and NO₂
 - [d] Use of our Products in places where the Products are exposed to static electricity or electromagnetic waves
 - [e] Use of our Products in proximity to heat-producing components, plastic cords, or other flammable items
 - [f] Sealing or coating our Products with resin or other coating materials
 - [g] Use of our Products without cleaning residue of flux (Exclude cases where no-clean type fluxes is used. However, recommend sufficiently about the residue.); or Washing our Products by using water or water-soluble cleaning agents for cleaning residue after soldering
 - [h] Use of the Products in places subject to dew condensation
4. The Products are not subject to radiation-proof design.
5. Please verify and confirm characteristics of the final or mounted products in using the Products.
6. In particular, if a transient load (a large amount of load applied in a short period of time, such as pulse, is applied, confirmation of performance characteristics after on-board mounting is strongly recommended. Avoid applying power exceeding normal rated power; exceeding the power rating under steady-state loading condition may negatively affect product performance and reliability.
7. De-rate Power Dissipation depending on ambient temperature. When used in sealed area, confirm that it is the use in the range that does not exceed the maximum junction temperature.
8. Confirm that operation temperature is within the specified range described in the product specification.
9. ROHM shall not be in any way responsible or liable for failure induced under deviant condition from what is defined in this document.

Precaution for Mounting / Circuit board design

1. When a highly active halogenous (chlorine, bromine, etc.) flux is used, the residue of flux may negatively affect product performance and reliability.
2. In principle, the reflow soldering method must be used on a surface-mount products, the flow soldering method must be used on a through hole mount products. If the flow soldering method is preferred on a surface-mount products, please consult with the ROHM representative in advance.

For details, please refer to ROHM Mounting specification

Precautions Regarding Application Examples and External Circuits

1. If change is made to the constant of an external circuit, please allow a sufficient margin considering variations of the characteristics of the Products and external components, including transient characteristics, as well as static characteristics.
2. You agree that application notes, reference designs, and associated data and information contained in this document are presented only as guidance for Products use. Therefore, in case you use such information, you are solely responsible for it and you must exercise your own independent verification and judgment in the use of such information contained in this document. ROHM shall not be in any way responsible or liable for any damages, expenses or losses incurred by you or third parties arising from the use of such information.

Precaution for Electrostatic

This Product is electrostatic sensitive product, which may be damaged due to electrostatic discharge. Please take proper caution in your manufacturing process and storage so that voltage exceeding the Products maximum rating will not be applied to Products. Please take special care under dry condition (e.g. Grounding of human body / equipment / solder iron, isolation from charged objects, setting of Ionizer, friction prevention and temperature / humidity control).

Precaution for Storage / Transportation

1. Product performance and soldered connections may deteriorate if the Products are stored in the places where:
 - [a] the Products are exposed to sea winds or corrosive gases, including Cl₂, H₂S, NH₃, SO₂, and NO₂
 - [b] the temperature or humidity exceeds those recommended by ROHM
 - [c] the Products are exposed to direct sunshine or condensation
 - [d] the Products are exposed to high Electrostatic
2. Even under ROHM recommended storage condition, solderability of products out of recommended storage time period may be degraded. It is strongly recommended to confirm solderability before using Products of which storage time is exceeding the recommended storage time period.
3. Store / transport cartons in the correct direction, which is indicated on a carton with a symbol. Otherwise bent leads may occur due to excessive stress applied when dropping of a carton.
4. Use Products within the specified time after opening a humidity barrier bag. Baking is required before using Products of which storage time is exceeding the recommended storage time period.

Precaution for Product Label

A two-dimensional barcode printed on ROHM Products label is for ROHM's internal use only.

Precaution for Disposition

When disposing Products please dispose them properly using an authorized industry waste company.

Precaution for Foreign Exchange and Foreign Trade act

Since concerned goods might be fallen under listed items of export control prescribed by Foreign exchange and Foreign trade act, please consult with ROHM in case of export.

Precaution Regarding Intellectual Property Rights

1. All information and data including but not limited to application example contained in this document is for reference only. ROHM does not warrant that foregoing information or data will not infringe any intellectual property rights or any other rights of any third party regarding such information or data.
2. ROHM shall not have any obligations where the claims, actions or demands arising from the combination of the Products with other articles such as components, circuits, systems or external equipment (including software).
3. No license, expressly or implied, is granted hereby under any intellectual property rights or other rights of ROHM or any third parties with respect to the Products or the information contained in this document. Provided, however, that ROHM will not assert its intellectual property rights or other rights against you or your customers to the extent necessary to manufacture or sell products containing the Products, subject to the terms and conditions herein.

Other Precaution

1. This document may not be reprinted or reproduced, in whole or in part, without prior written consent of ROHM.
2. The Products may not be disassembled, converted, modified, reproduced or otherwise changed without prior written consent of ROHM.
3. In no event shall you use in any way whatsoever the Products and the related technical information contained in the Products or this document for any military purposes, including but not limited to, the development of mass-destruction weapons.
4. The proper names of companies or products described in this document are trademarks or registered trademarks of ROHM, its affiliated companies or third parties.

General Precaution

1. Before you use our Products, you are requested to carefully read this document and fully understand its contents. ROHM shall not be in any way responsible or liable for failure, malfunction or accident arising from the use of any ROHM's Products against warning, caution or note contained in this document.
2. All information contained in this document is current as of the issuing date and subject to change without any prior notice. Before purchasing or using ROHM's Products, please confirm the latest information with a ROHM sales representative.
3. The information contained in this document is provided on an "as is" basis and ROHM does not warrant that all information contained in this document is accurate and/or error-free. ROHM shall not be in any way responsible or liable for any damages, expenses or losses incurred by you or third parties resulting from inaccuracy or errors of or concerning such information.