

Features

- 650 V, 75 A, Low Collector-Emitter Saturation Voltage ($V_{CE(sat)}$)
- Novel trench-gate field-stop technology
- Optimized for conduction
- High-speed switching
- Maximum operating $T_j = 175\text{ }^\circ\text{C}$
- RoHS compliant*

Applications

- Switched-Mode Power Supplies (SMPS)
- Uninterruptible Power Sources (UPS)
- Power Factor Correction (PFC)
- Inverters
- Welding converters
- Photovoltaic

BIDW75N65EH5 Insulated Gate Bipolar Transistor (IGBT)

General Information

The Bourns® Model BIDW75N65EH5 IGBT device combines technology from a MOS gate and a bipolar transistor, resulting in an optimum component for high voltage and high current applications. This device uses Trench-Gate Field-Stop technology providing greater control of dynamic characteristics while resulting in a lower Collector-Emitter Saturation Voltage ($V_{CE(sat)}$) and fewer switching losses.

Additional Information

Click these links for more information:



Maximum Electrical Ratings ($T_C = 25\text{ }^\circ\text{C}$, unless otherwise specified)

Parameter	Symbol	Value	Unit
Collector-Emitter Voltage	V_{CES}	650	V
Continuous Collector Current ($T_C = 25\text{ }^\circ\text{C}$), limited by T_{jmax}	I_C	150	A
Continuous Collector Current ($T_C = 100\text{ }^\circ\text{C}$), limited by T_{jmax}	I_C	75	A
Pulsed Collector Current, t_p limited by T_{jmax}	I_{CP}	300	A
Gate-Emitter Voltage	V_{GE}	± 20	V
Gate-Emitter Voltage ($t_p \leq 10\text{ }\mu\text{s}$, $D < 1\%$)	V_{GE}	± 30	V
Continuous Forward Current ($T_C = 100\text{ }^\circ\text{C}$), limited by T_{jmax}	I_F	75	A
Total Power Dissipation	P_{total}	394	W
Storage Temperature	T_{STG}	-55 to +150	$^\circ\text{C}$
Operating Junction Temperature	T_j	-40 to +175	$^\circ\text{C}$

Thermal Resistance

Parameter	Symbol	Max	Unit
IGBT Thermal Resistance Junction - Case	$R_{th(j-c)}_{IGBT}$	0.38	$^\circ\text{C/W}$
Diode Thermal Resistance Junction - Case	$R_{th(j-c)}_{Diode}$	0.4	$^\circ\text{C/W}$

Typical Part Marking

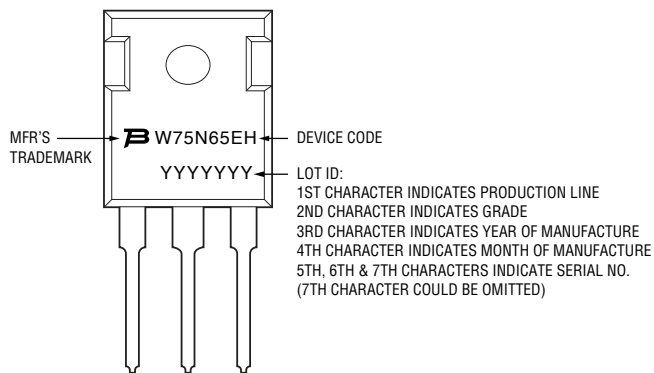

Internal Circuit

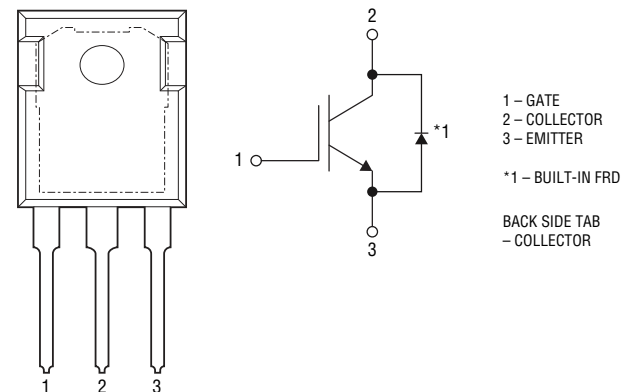

*RoHS Directive 2015/863, Mar 31, 2015 and Annex. Specifications are subject to change without notice. Users should verify actual device performance in their specific applications. The products described herein and this document are subject to specific legal disclaimers as set forth on the last page of this document, and at www.bourns.com/docs/legal/disclaimer.pdf.

BIDW75N65EH5 Insulated Gate Bipolar Transistor (IGBT)

BOURNS®

Static Electrical Characteristics ($T_C = 25\text{ }^\circ\text{C}$, Unless Otherwise Specified)

Parameter	Symbol	Conditions	Value			Unit
			Min.	Typ.	Max.	
Collector-Emitter Breakdown Voltage	BV_{CES}	$V_{GE} = 0\text{ V}$, $I_C = 250\text{ }\mu\text{A}$	650	—	—	V
Collector-Emitter Saturation Voltage	$V_{CE(sat)}$	$V_{GE} = 15\text{ V}$, $I_C = 75\text{ A}$, $T_C = 25\text{ }^\circ\text{C}$	—	1.65	2.2	V
		$V_{GE} = 15\text{ V}$, $I_C = 75\text{ A}$, $T_C = 150\text{ }^\circ\text{C}$	—	2.05	—	
Diode Forward On-Voltage	V_F	$I_F = 75\text{ A}$, $T_C = 25\text{ }^\circ\text{C}$	—	1.55	1.9	V
		$I_F = 75\text{ A}$, $T_C = 150\text{ }^\circ\text{C}$	—	1.45	—	V
Gate Threshold Voltage	$V_{GE(th)}$	$V_{CE} = V_{GE}$, $I_C = 250\text{ }\mu\text{A}$	3.2	4.0	4.8	V
Collector Cut-off Current	I_{CES}	$V_{GE} = 0\text{ V}$, $V_{CE} = 650\text{ V}$	—	—	75	μA
Gate-Emitter Leakage Current	I_{GES}	$V_{CE} = 0\text{ V}$, $V_{GE} = \pm 20\text{ V}$	—	—	± 100	nA

Dynamic Electrical Characteristics ($T_C = 25\text{ }^\circ\text{C}$, Unless Otherwise Specified)

Parameter	Symbol	Conditions	Value			Unit
			Min.	Typ.	Max.	
Input Capacitance	C_{ies}	$V_{CE} = 30\text{ V}$, $V_{GE} = 0\text{ V}$, $f = 1\text{ MHz}$	—	4829	—	pF
Output Capacitance	C_{oes}		—	132	—	
Reverse Transfer Capacitance	C_{res}		—	21	—	
Total Gate Charge	Q_g	$V_{CE} = 520\text{ V}$, $V_{GE} = 15\text{ V}$, $I_C = 75.0\text{ A}$	—	186	—	nC
Gate-Emitter Charge	Q_{ge}		—	38	—	
Gate-Collector Charge	Q_{gc}		—	50	—	

IGBT Switching Characteristics (Inductive Load, $T_C = 25\text{ }^\circ\text{C}$, unless otherwise specified)

Parameter	Symbol	Conditions	Value			Unit
			Min.	Typ.	Max.	
Turn-on Delay Time	$t_{d(on)}$	$V_{CE} = 400\text{ V}$, $V_{GE} = 15\text{ V}$, $I_C = 75.0\text{ A}$, $R_G = 10\text{ }\Omega$	—	39	—	ns
Current Rise Time	t_r		—	44	—	ns
Turn-off Delay Time	$t_{d(off)}$		—	186	—	ns
Current Fall Time	t_f		—	38	—	ns
Turn-on Switching Energy	E_{on}		—	2.39	—	mJ
Turn-off Switching Energy	E_{off}		—	0.9	—	mJ
Total Switching Energy	E_{ts}		—	3.29	—	mJ

Specifications are subject to change without notice.

Users should verify actual device performance in their specific applications.

The products described herein and this document are subject to specific legal disclaimers as set forth on the last page of this document, and at www.bourns.com/docs/legal/disclaimer.pdf.

BIDW75N65EH5 Insulated Gate Bipolar Transistor (IGBT)



Diode Switching Characteristics ($T_C = 25\text{ }^\circ\text{C}$, unless otherwise specified)

Parameter	Symbol	Conditions	Value			Unit
			Min.	Typ.	Max.	
Reverse Recovery Time	t_{rr}	$di_F/dt = 200\text{ A}/\mu\text{s}$, $I_F = 75.0\text{ A}$	—	120	—	ns
Reverse Recovery Charge	Q_{rr}		—	0.4	—	μC

Electrical Characteristic Performance

Typical Output Characteristics @ $T_C = 25\text{ }^\circ\text{C}$

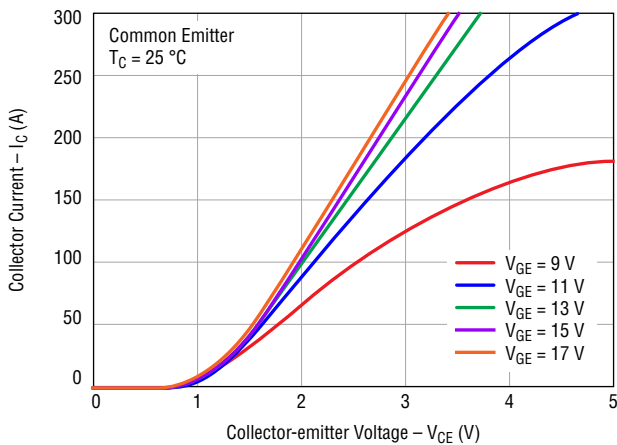

Typical Output Characteristics @ $T_C = 150\text{ }^\circ\text{C}$

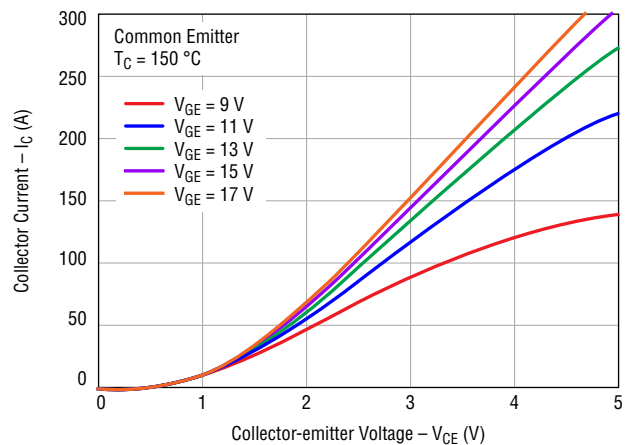

Typical Saturation Voltage Characteristics

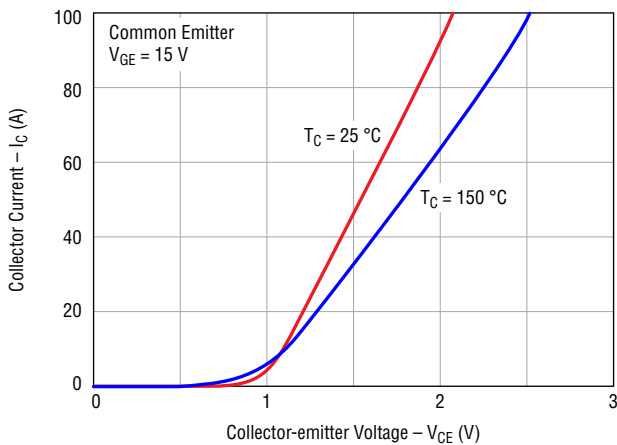

Typical Transfer Characteristics

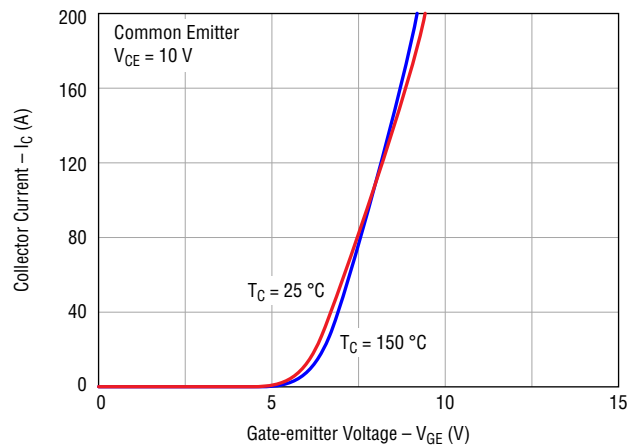

Specifications are subject to change without notice.

Users should verify actual device performance in their specific applications.

The products described herein and this document are subject to specific legal disclaimers as set forth on the last page of this document, and at www.bourns.com/docs/legal/disclaimer.pdf.

Electrical Characteristic Performance (continued)

Typical Saturation Voltage Drop vs V_{GE} @ $T_C = 25^\circ\text{C}$

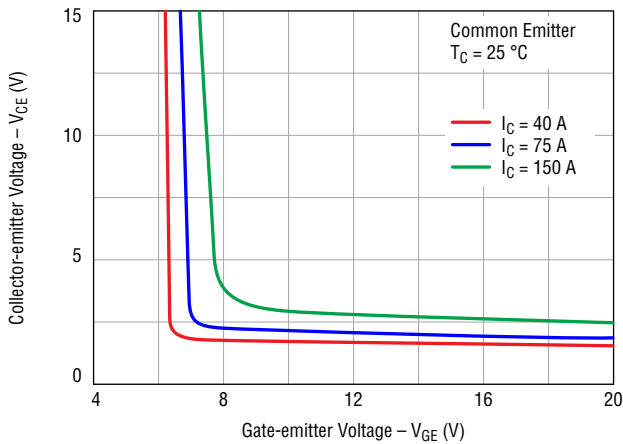

Typical Saturation Voltage Drop vs V_{GE} @ $T_C = 150^\circ\text{C}$

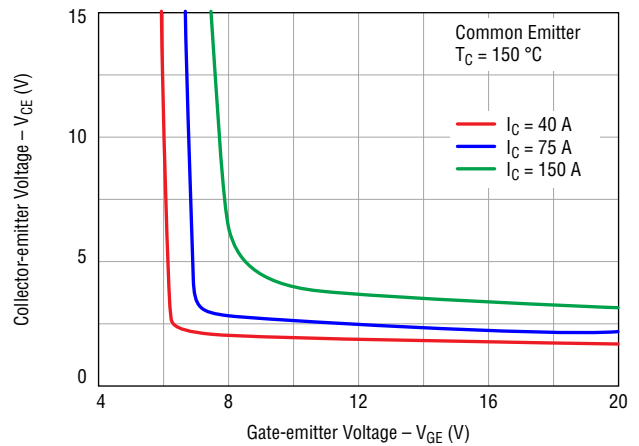

Typical Saturation Voltage Drop vs Temperature

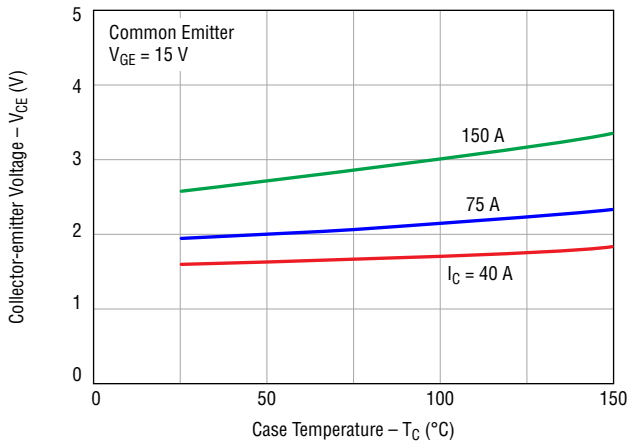

Typical Capacitance Characteristics

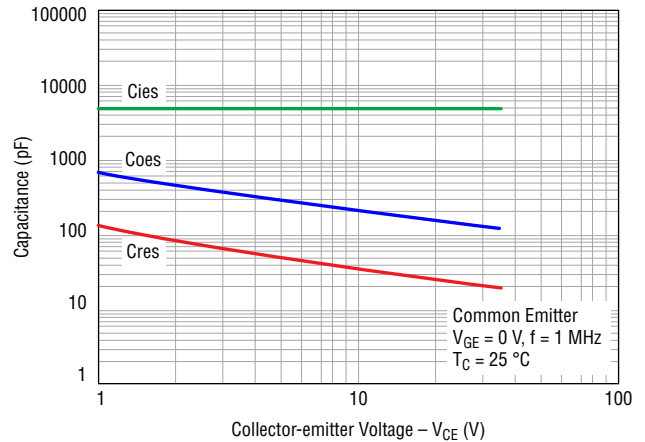

Specifications are subject to change without notice.

Users should verify actual device performance in their specific applications.

The products described herein and this document are subject to specific legal disclaimers as set forth on the last page of this document, and at www.bourns.com/docs/legal/disclaimer.pdf.

Electrical Characteristic Performance (continued)

Typical Gate Charge Characteristics

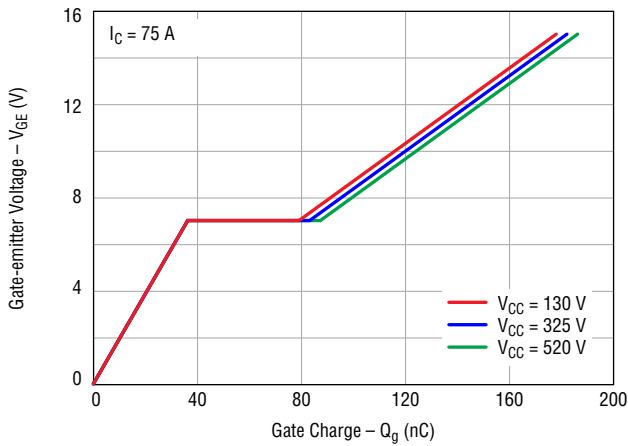

Typical Forward Characteristics

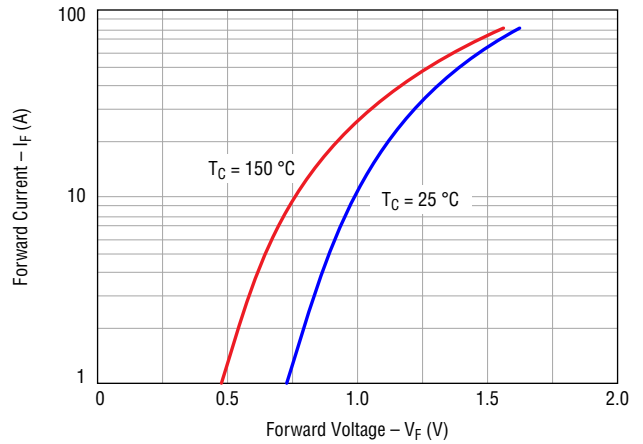

Typical Turn-on Characteristics vs Gate Resistance @ $T_C = 25$ °C

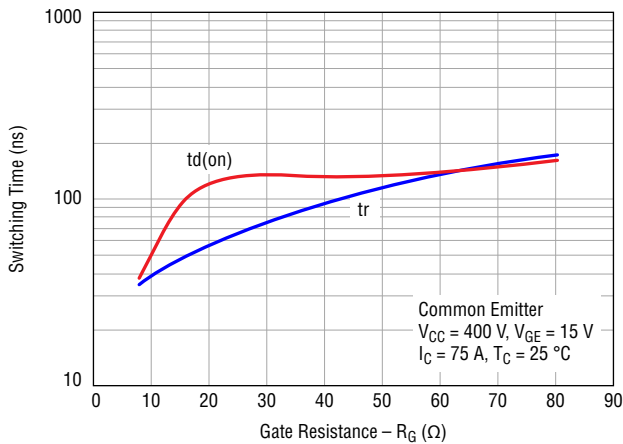

Typical Turn-on Characteristics vs Gate Resistance @ $T_C = 150$ °C

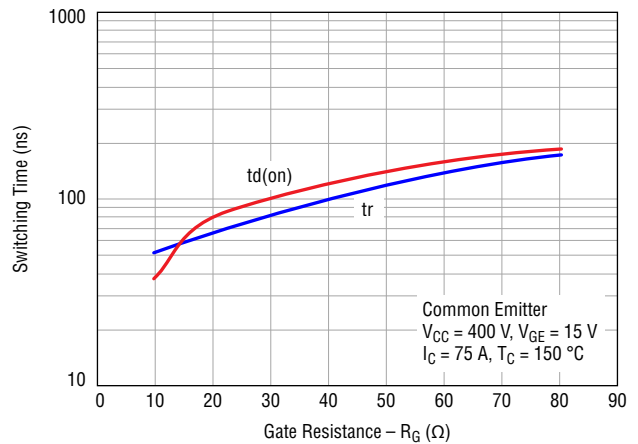

BIDW75N65EH5 Insulated Gate Bipolar Transistor (IGBT)



Electrical Characteristic Performance (continued)

Typical Turn-off Characteristics vs Gate Resistance @ $T_C = 25\text{ }^\circ\text{C}$

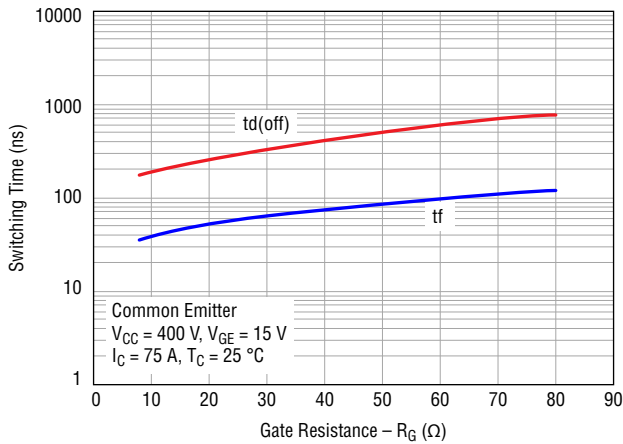

Typical Turn-off Characteristics vs Gate Resistance @ $T_C = 150\text{ }^\circ\text{C}$

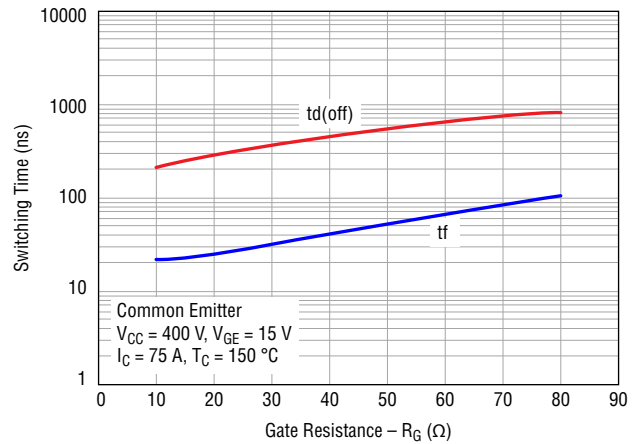

Typical Switching Loss vs Gate Resistance @ $T_C = 25\text{ }^\circ\text{C}$

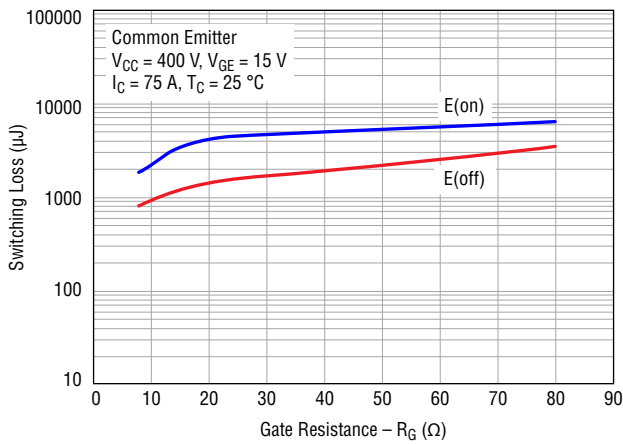

Typical Switching Loss vs Gate Resistance @ $T_C = 150\text{ }^\circ\text{C}$

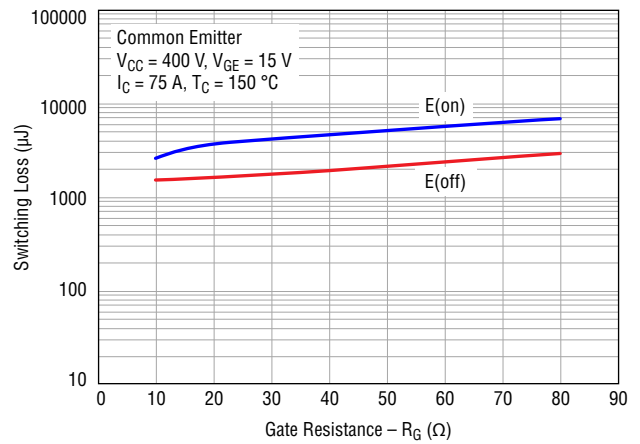

Specifications are subject to change without notice.

Users should verify actual device performance in their specific applications.

The products described herein and this document are subject to specific legal disclaimers as set forth on the last page of this document, and at www.bourns.com/docs/legal/disclaimer.pdf.

Electrical Characteristic Performance (continued)

Typical Turn-on Characteristics vs Collector Current @ $T_C = 25\text{ }^\circ\text{C}$

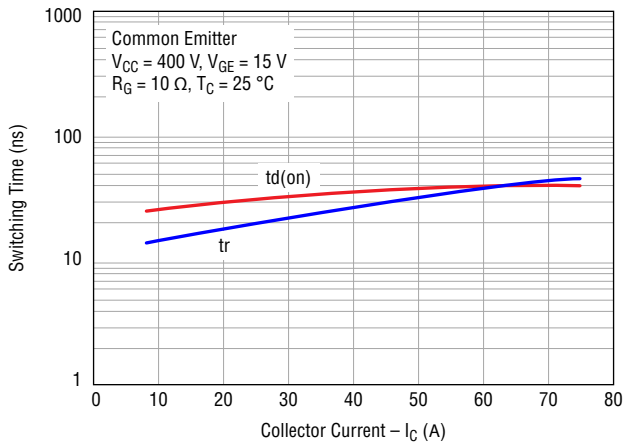

Typical Turn-on Characteristics vs Collector Current @ $T_C = 150\text{ }^\circ\text{C}$

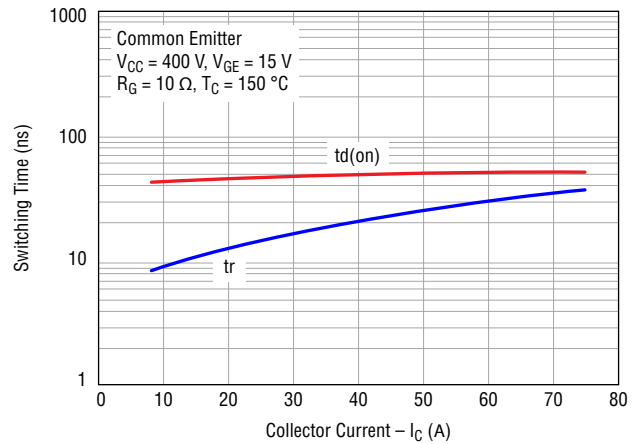

Typical Turn-off Characteristics vs Collector Current @ $T_C = 25\text{ }^\circ\text{C}$

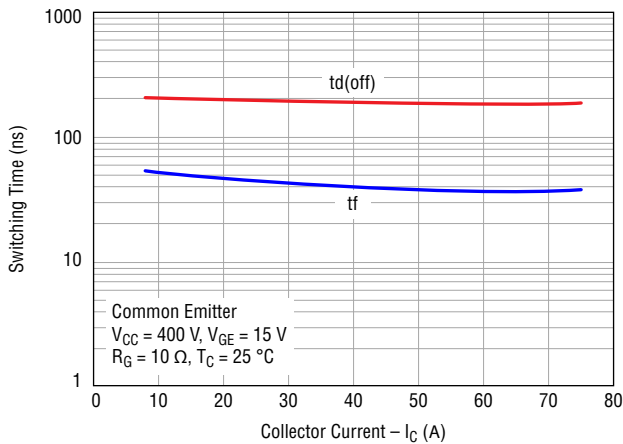

Typical Turn-off Characteristics vs Collector Current @ $T_C = 150\text{ }^\circ\text{C}$

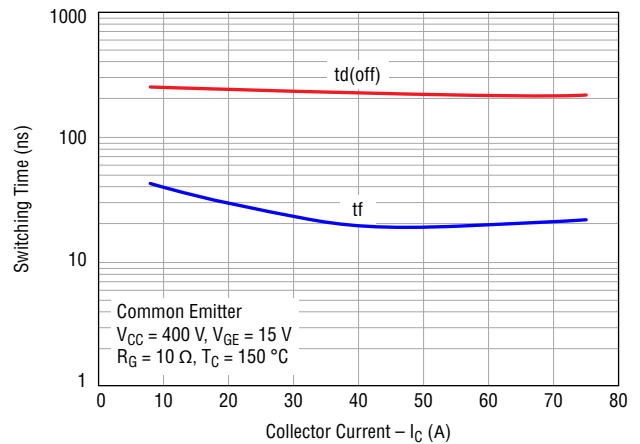

Specifications are subject to change without notice.

Users should verify actual device performance in their specific applications.

The products described herein and this document are subject to specific legal disclaimers as set forth on the last page of this document, and at www.bourns.com/docs/legal/disclaimer.pdf.

Electrical Characteristic Performance (continued)

Typical Switching Loss vs Collector Current @ $T_C = 25\text{ }^\circ\text{C}$

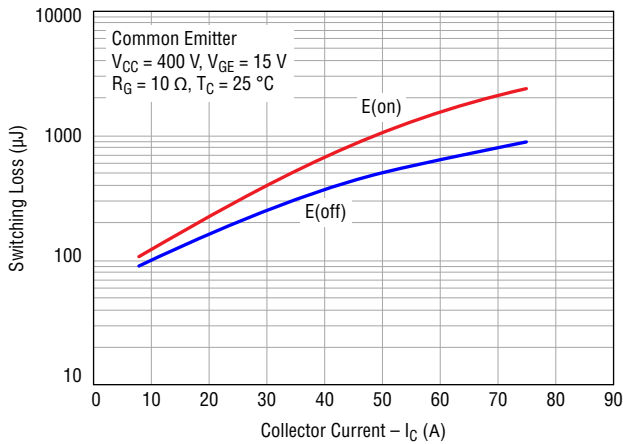

Typical Switching Loss vs Collector Current @ $T_C = 150\text{ }^\circ\text{C}$

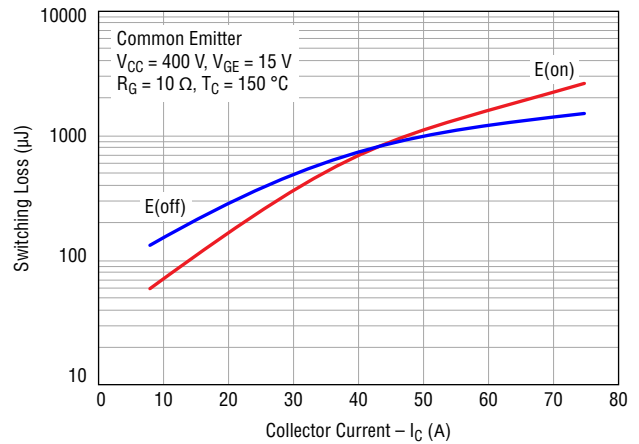

Typical Reverse Recovery Time vs Forward Current

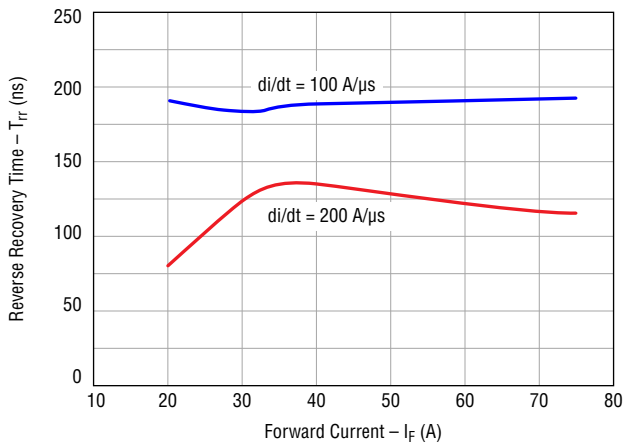

Typical Reverse Recovery Charge vs Forward Current

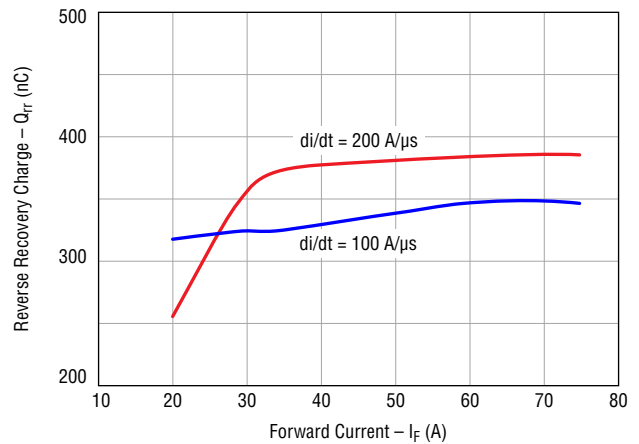

Specifications are subject to change without notice.

Users should verify actual device performance in their specific applications.

The products described herein and this document are subject to specific legal disclaimers as set forth on the last page of this document, and at www.bourns.com/docs/legal/disclaimer.pdf.

Electrical Characteristic Performance (continued)

Typical Peak Reverse Recovery Current vs Forward Current

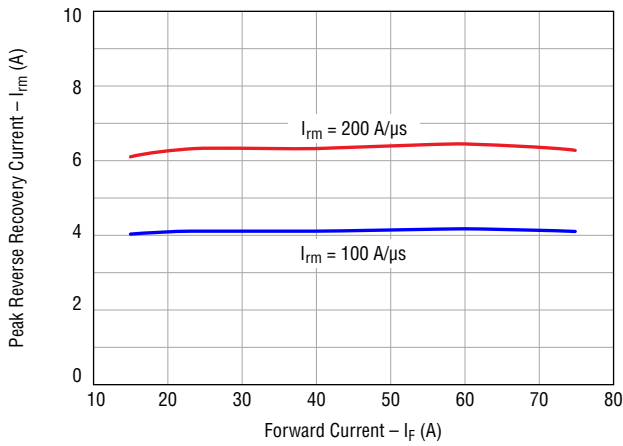

Typical Slope vs Forward Current

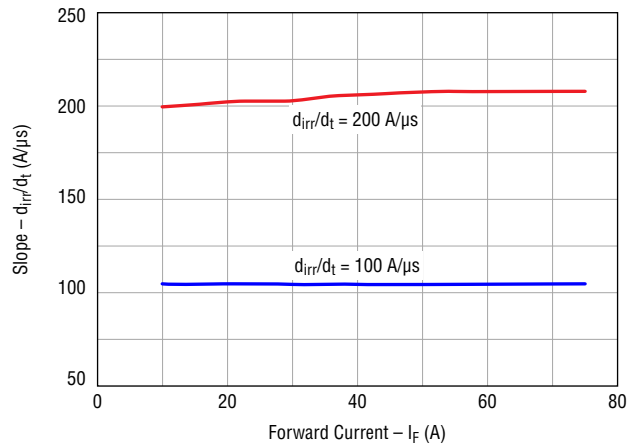

Maximum Safe Operating Area

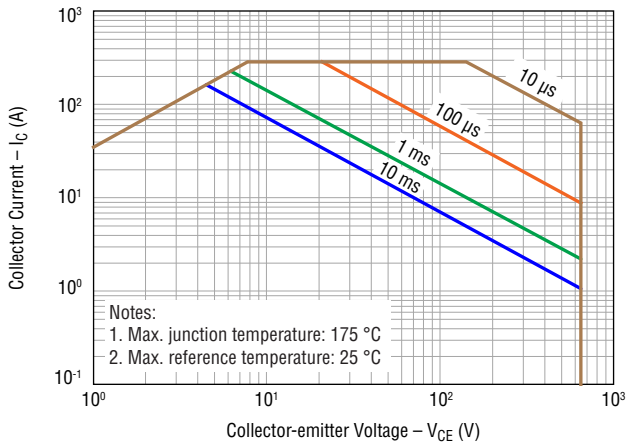

Specifications are subject to change without notice.

Users should verify actual device performance in their specific applications.

The products described herein and this document are subject to specific legal disclaimers as set forth on the last page of this document, and at www.bourns.com/docs/legal/disclaimer.pdf.

Electrical Characteristic Performance (continued)

IGBT Transient Thermal Impedance vs $t_{p(on)}$ Duration ($D=t_p/T$)

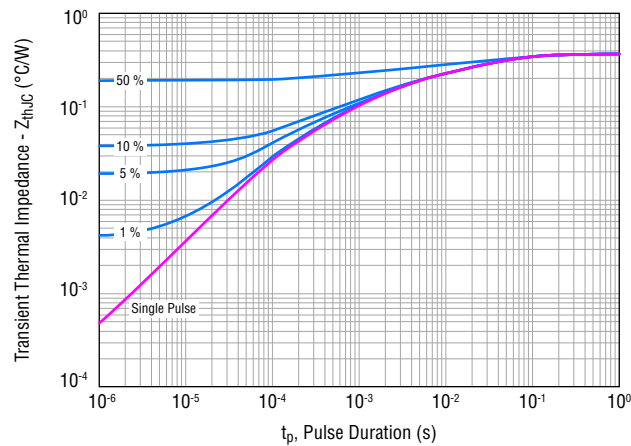

Diode Transient Thermal Impedance vs $t_{p(on)}$ Duration ($D=t_p/T$)

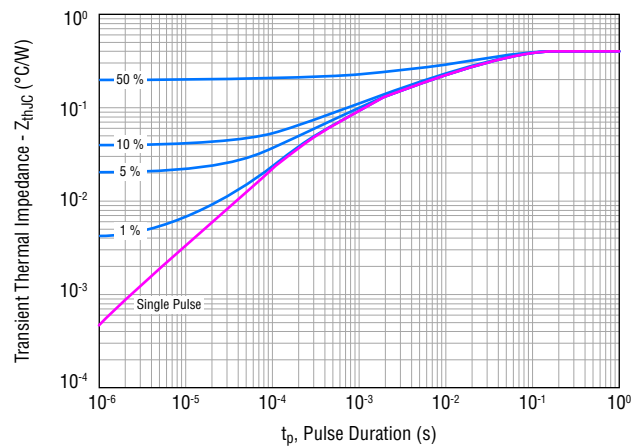

Specifications are subject to change without notice.

Users should verify actual device performance in their specific applications.

The products described herein and this document are subject to specific legal disclaimers as set forth on the last page of this document, and at www.bourns.com/docs/legal/disclaimer.pdf.

BIDW75N65EH5 Insulated Gate Bipolar Transistor (IGBT)



Inductive Load Test Circuit

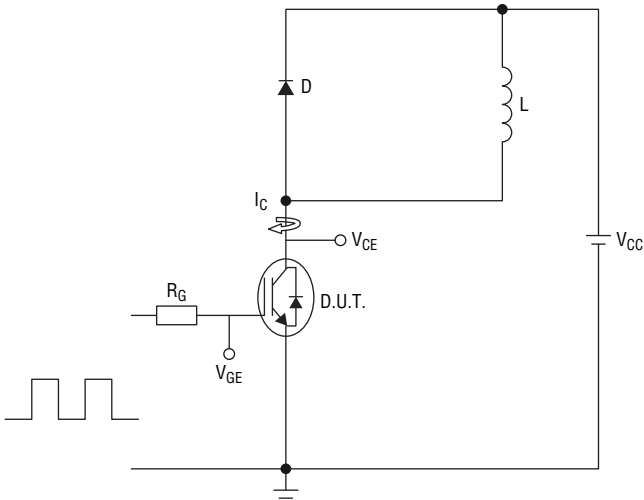

$L = 100 \mu\text{H}$, $V_{CE} = 400 \text{ V}$, $V_{GE} = 15 \text{ V}$, $I_C = 75 \text{ A}$, $R_G = 10 \Omega$

How to Order

B I D W 75 N 65 EH5

B = Bourns® _____
 I = IGBT _____
 Type _____
 D = Discrete
 Package Code _____
 W = TO-247-3L
 Current Rating _____
 75 = 75 A
 Device Type _____
 N = N-channel
 Nominal Voltage (divided by 10) _____
 65 = 650 V
 Optimization _____
 EH = Extremely High Speed
 Version Number _____
 5 = Revision Control

Environmental Characteristics

ESD Class (HBM)2

BIDW75N65EH5 Insulated Gate Bipolar Transistor (IGBT)



Product Dimensions

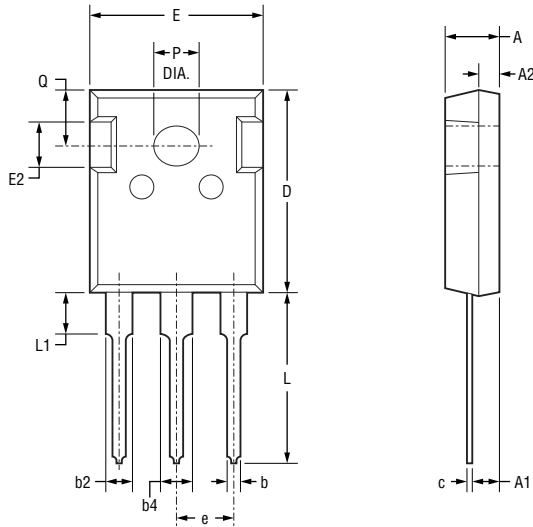

DIMENSIONS: $\frac{\text{MM}}{\text{(INCHES)}}$

Symbol	Min.	Nom.	Max.
A	$\frac{4.80}{(.189)}$	$\frac{5.00}{(.197)}$	$\frac{5.20}{(.205)}$
A1	$\frac{2.21}{(.087)}$	$\frac{2.41}{(.095)}$	$\frac{2.59}{(.102)}$
A2	$\frac{1.85}{(.073)}$	$\frac{2.00}{(.079)}$	$\frac{2.15}{(.085)}$
b	$\frac{1.11}{(.044)}$	—	$\frac{1.36}{(.054)}$
b2	$\frac{1.91}{(.075)}$	—	$\frac{2.25}{(.089)}$
b4	$\frac{2.91}{(.115)}$	—	$\frac{3.25}{(.128)}$
c	$\frac{0.51}{(.020)}$	—	$\frac{0.75}{(.030)}$
D	$\frac{20.80}{(.819)}$	$\frac{21.00}{(.827)}$	$\frac{21.30}{(.839)}$
E	$\frac{15.50}{(.610)}$	$\frac{15.80}{(.622)}$	$\frac{16.10}{(.634)}$
E2	$\frac{4.40}{(.173)}$	$\frac{5.00}{(.197)}$	$\frac{5.20}{(.205)}$
e	$\frac{5.44}{(.214)}$ BSC		
L	$\frac{19.72}{(.776)}$	$\frac{19.92}{(.784)}$	$\frac{20.22}{(.796)}$
L1	—	—	$\frac{4.30}{(.169)}$
P	$\frac{3.40}{(.134)}$	—	$\frac{3.80}{(.150)}$
Q	$\frac{5.60}{(.220)}$	$\frac{5.80}{(.228)}$	$\frac{6.00}{(.236)}$

Packaging Specifications

BIDW75N65EH5..... 30 pieces per tube



Asia-Pacific: Tel: +886-2 2562-4117

Email: asiacus@bourns.com

EMEA: Tel: +36 88 885 877

Email: eurocus@bourns.com

The Americas: Tel: +1-951 781-5500

Email: americus@bourns.com

www.bourns.com

REV. 11/23

Specifications are subject to change without notice.

Users should verify actual device performance in their specific applications.

The products described herein and this document are subject to specific legal disclaimers as set forth on the last page of this document, and at www.bourns.com/docs/legal/disclaimer.pdf.

This legal disclaimer applies to purchasers and users of Bourns® products manufactured by or on behalf of Bourns, Inc. and its affiliates (collectively, “Bourns”).

Unless otherwise expressly indicated in writing, Bourns® products and data sheets relating thereto are subject to change without notice. Users should check for and obtain the latest relevant information and verify that such information is current and complete before placing orders for Bourns® products.

The characteristics and parameters of a Bourns® product set forth in its data sheet are based on laboratory conditions, and statements regarding the suitability of products for certain types of applications are based on Bourns’ knowledge of typical requirements in generic applications. The characteristics and parameters of a Bourns® product in a user application may vary from the data sheet characteristics and parameters due to (i) the combination of the Bourns® product with other components in the user’s application, or (ii) the environment of the user application itself. The characteristics and parameters of a Bourns® product also can and do vary in different applications and actual performance may vary over time. Users should always verify the actual performance of the Bourns® product in their specific devices and applications, and make their own independent judgments regarding the amount of additional test margin to design into their device or application to compensate for differences between laboratory and real world conditions.

Unless Bourns has explicitly designated an individual Bourns® product as meeting the requirements of a particular industry standard (e.g., ISO/TS 16949) or a particular qualification (e.g., UL listed or recognized), Bourns is not responsible for any failure of an individual Bourns® product to meet the requirements of such industry standard or particular qualification. Users of Bourns® products are responsible for ensuring compliance with safety-related requirements and standards applicable to their devices or applications.

Bourns® products are not recommended, authorized or intended for use in nuclear, lifesaving, life-critical or life-sustaining applications, nor in any other applications where failure or malfunction may result in personal injury, death, or severe property or environmental damage. Unless expressly and specifically approved in writing by two authorized Bourns representatives on a case-by-case basis, use of any Bourns® products in such unauthorized applications might not be safe and thus is at the user’s sole risk. Life-critical applications include devices identified by the U.S. Food and Drug Administration as Class III devices and generally equivalent classifications outside of the United States.

Bourns expressly identifies those Bourns® standard products that are suitable for use in automotive applications on such products’ data sheets in the section entitled “Applications.” Unless expressly and specifically approved in writing by two authorized Bourns representatives on a case-by-case basis, use of any other Bourns® standard products in an automotive application might not be safe and thus is not recommended, authorized or intended and is at the user’s sole risk. If Bourns expressly identifies a sub-category of automotive application in the data sheet for its standard products (such as infotainment or lighting), such identification means that Bourns has reviewed its standard product and has determined that if such Bourns® standard product is considered for potential use in automotive applications, it should only be used in such sub-category of automotive applications. Any reference to Bourns® standard product in the data sheet as compliant with the AEC-Q standard or “automotive grade” does not by itself mean that Bourns has approved such product for use in an automotive application.

Bourns® standard products are not tested to comply with United States Federal Aviation Administration standards generally or any other generally equivalent governmental organization standard applicable to products designed or manufactured for use in aircraft or space applications. Bourns expressly identifies Bourns® standard products that are suitable for use in aircraft or space applications on such products’ data sheets in the section entitled “Applications.” Unless expressly and specifically approved in writing by two authorized Bourns representatives on a case-by-case basis, use of any other Bourns® standard product in an aircraft or space application might not be safe and thus is not recommended, authorized or intended and is at the user’s sole risk.

The use and level of testing applicable to Bourns® custom products shall be negotiated on a case-by-case basis by Bourns and the user for which such Bourns® custom products are specially designed. Absent a written agreement between Bourns and the user regarding the use and level of such testing, the above provisions applicable to Bourns® standard products shall also apply to such Bourns® custom products.

Users shall not sell, transfer, export or re-export any Bourns® products or technology for use in activities which involve the design, development, production, use or stockpiling of nuclear, chemical or biological weapons or missiles, nor shall they use Bourns® products or technology in any facility which engages in activities relating to such devices. The foregoing restrictions apply to all uses and applications that violate national or international prohibitions, including embargos or international regulations. Further, Bourns® products and Bourns technology and technical data may not under any circumstance be exported or re-exported to countries subject to international sanctions or embargoes. Bourns® products may not, without prior authorization from Bourns and/or the U.S. Government, be resold, transferred, or re-exported to any party not eligible to receive U.S. commodities, software, and technical data.

To the maximum extent permitted by applicable law, Bourns disclaims (i) any and all liability for special, punitive, consequential, incidental or indirect damages or lost revenues or lost profits, and (ii) any and all implied warranties, including implied warranties of fitness for particular purpose, non-infringement and merchantability.

For your convenience, copies of this Legal Disclaimer Notice with German, Spanish, Japanese, Traditional Chinese and Simplified Chinese bilingual versions are available at:

Web Page: <http://www.bourns.com/legal/disclaimers-terms-and-policies>

PDF: <http://www.bourns.com/docs/Legal/disclaimer.pdf>