

284703-1 ✓ ACTIVE

AMP | MQS

TE Internal #: 284703-1

Housing for Female Terminals, Wire-to-Wire, 2 Position, .157 in [4 mm] Centerline, Sealable, Black, Wire & Cable, Signal, MQS

[View on TE.com >](#)



Connectors > Automotive Connectors > Automotive Housings > MQS, CONNECTOR HOUSING

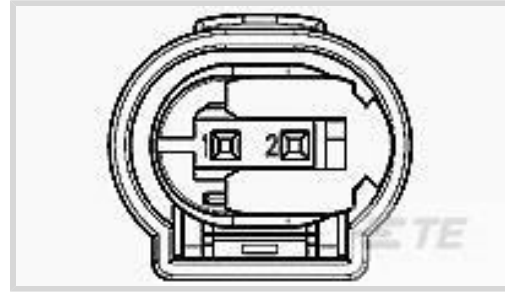

Connector System: **Wire-to-Wire**

Number of Positions: **2**

Connector & Housing Type: **Housing for Female Terminals**

Centerline (Pitch): **4 mm [.157 in]**

Sealable: **Yes**

[All MQS, CONNECTOR HOUSING \(437\)](#)

Features

Product Type Features

Mixed & Hybrid Connector	No
Connector Shape	Rectangular
Connector System	Wire-to-Wire
Connector & Housing Type	Housing for Female Terminals
Sealable	Yes
Connector & Contact Terminates To	Wire & Cable
Primary Locking Feature	On the Terminal

Configuration Features

Number of Positions	2
Number of Rows	1

Electrical Characteristics

Operating Voltage	24 VDC
Nominal Voltage Architecture	24 V

Body Features

Cable Exit Angle	180°
Primary Product Color	Black
Connector & Keying Code	A



Contact Features

Contact Size	.64mm
Contact Type	Receptacle
Mating Tab Width	.63 mm[.025 in]
Contact Current Rating (Max)	5 A

Mechanical Attachment

Terminal Position Assurance	Yes
Strain Relief	Without
Mating Alignment Type	Keyed
Mating Alignment	With
Connector Mounting Type	Cable Mount (Free-Hanging)

Housing Features

Housing Material	PA GF
Centerline (Pitch)	4 mm[.157 in]

Dimensions

Connector Height	22.1 mm[.87 in]
Product Width	14.4 mm[.567 in]
Product Length	17.4 mm[.685 in]

Usage Conditions

Operating Temperature (Max)	70 °C, 75 °C, 80 °C, 85 °C, 90 °C, 100 °C, 105 °C, 110 °C, 120 °C, 125 °C[158 °F][167 °F][176 °F][185 °F][194 °F][212 °F][221 °F][230 °F][248 °F][257 °F]
Operating Temperature Range	-30 – 125 °C[-22 – 257 °F]

Operation/Application

Circuit Application	Signal
---------------------	--------

Packaging Features

Packaging Method	Box
------------------	-----

Other

Serviceable	No
Connector Position Assurance Capable	No

Product Compliance





[For compliance documentation, visit the product page on TE.com>](#)

EU RoHS Directive 2011/65/EU	Compliant
EU ELV Directive 2000/53/EC	Compliant
China RoHS 2 Directive MIIT Order No 32, 2016	No Restricted Materials Above Threshold
EU REACH Regulation (EC) No. 1907/2006	Current ECHA Candidate List: JUNE 2023 (235) Candidate List Declared Against: JUNE 2023 (235) Does not contain REACH SVHC
Halogen Content	BFR/CFR/PVC Free, but Br/Cl >900 ppm in other sources.
Solder Process Capability	Not applicable for solder process capability

Product Compliance Disclaimer

This information is provided based on reasonable inquiry of our suppliers and represents our current actual knowledge based on the information they provided. This information is subject to change. The part numbers that TE has identified as EU RoHS compliant have a maximum concentration of 0.1% by weight in homogenous materials for lead, hexavalent chromium, mercury, PBB, PBDE, DBP, BBP, DEHP, DIBP, and 0.01% for cadmium, or qualify for an exemption to these limits as defined in the Annexes of Directive 2011/65/EU (RoHS2). Finished electrical and electronic equipment products will be CE marked as required by Directive 2011/65/EU. Components may not be CE marked. Additionally, the part numbers that TE has identified as EU ELV compliant have a maximum concentration of 0.1% by weight in homogenous materials for lead, hexavalent chromium, and mercury, and 0.01% for cadmium, or qualify for an exemption to these limits as defined in the Annexes of Directive 2000/53/EC (ELV). Regarding the REACH Regulation, the information TE provides on SVHC in articles for this part number is based on the latest European Chemicals Agency (ECHA) 'Guidance on requirements for substances in articles' posted at this URL: <https://echa.europa.eu/guidance-documents/guidance-on-reach>

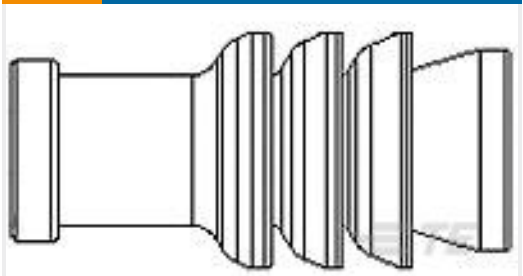
Compatible Parts

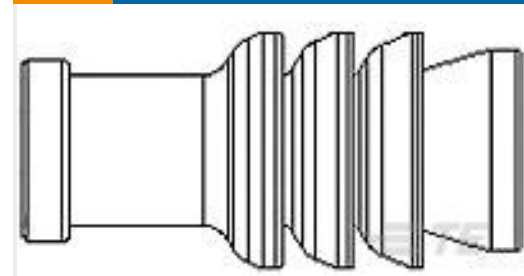
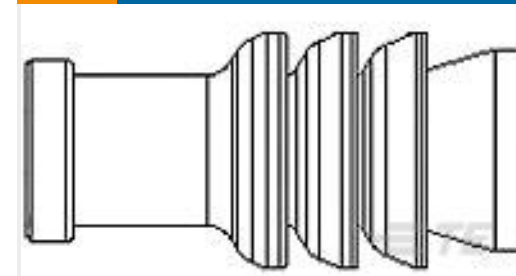
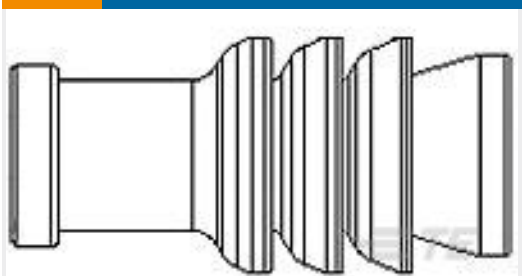
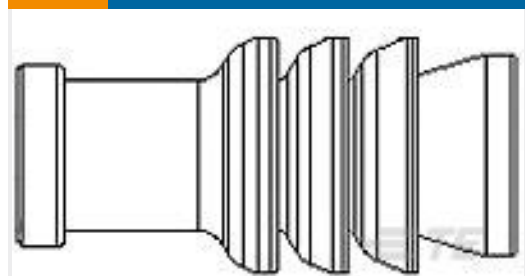
 <p>TE Part # 963142-1 MQS SINGLE-WIRE SEAL FOR 4MM</p>	 <p>TE Part # 963143-1 MQS BLINDSTOPFEN</p>	 <p>TE Part # 967056-1 MQS BLINDSTOPFEN4MM</p>	 <p>TE Part # 963142-2 SWS,MQS,CVTY DIA,4.0,GRY</p>
 <p>TE Part # 967067-1 MQS SGL WIRE SEAL</p>	 <p>TE Part # 967067-2 MQS EINZELLEITDICHT</p>	<p>TE Part # 284700-1 MQS SOCKET HSG 2 POS.</p>	

Also in the Series | MQS



Automotive Connector Caps & Covers (111)



Automotive Connector EMC Shielding (3)

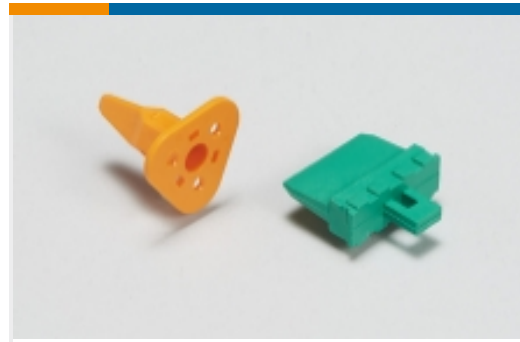

Automotive Connector Locks & Position Assurance (27)



Automotive Housings (375)



Automotive Terminals (89)



Connector Seals & Cavity Plugs (26)



Insertion & Extraction Tools (42)



Other Automotive Connector Accessories (7)

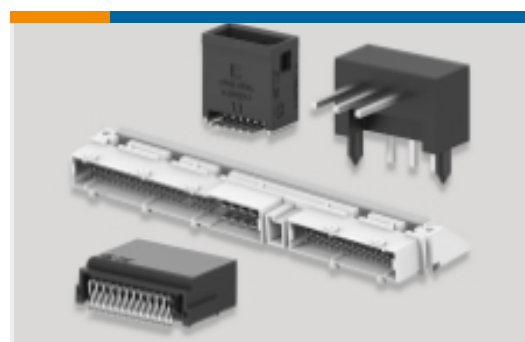

PCB Headers & Receptacles (143)

Customers Also Bought

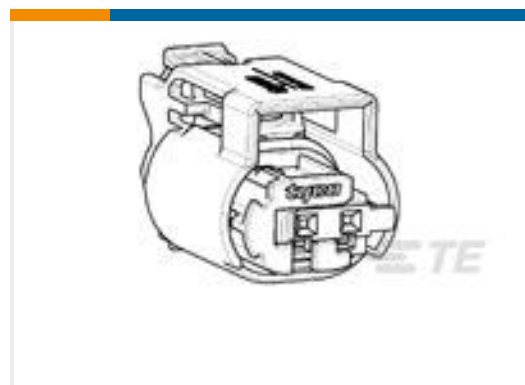

TE Part #1-1438608-5
2POS MQS REC SEALED COD A

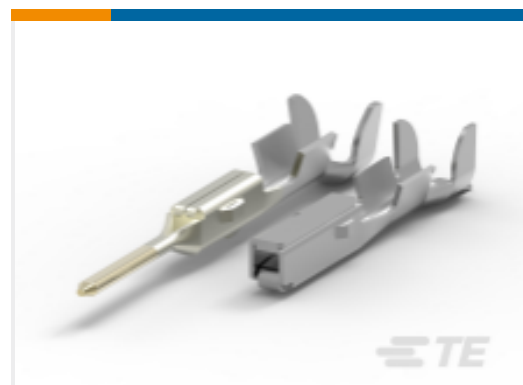

TE Part #284088-1
MULTILOCK, RECEPTACLE AND TAB

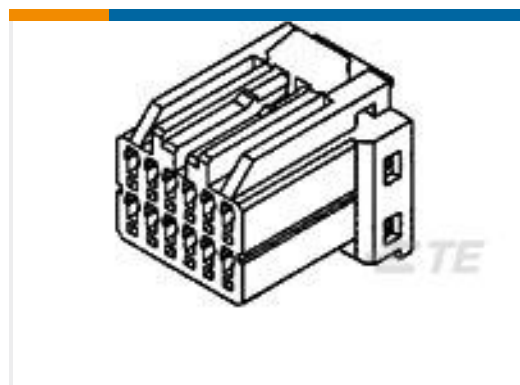

TE Part #174910-2
040 MLC PLUG HSG 20P



TE Part #2112502-1
38POS, MIXED, REC HSG, ASSY, SEALED



TE Part #1745003-1
18 POS. FRAME ASSY CRIMP/CRIMP



TE Part #2309993-1
8POS, MQS, REC HSG ASSY, SLD, COD 1



TE Part #2309993-2
8POS, MQS, REC HSG ASSY, SLD, COD 2



TE Part #281991-2
HSG FOR P-LOCK MK I TERM

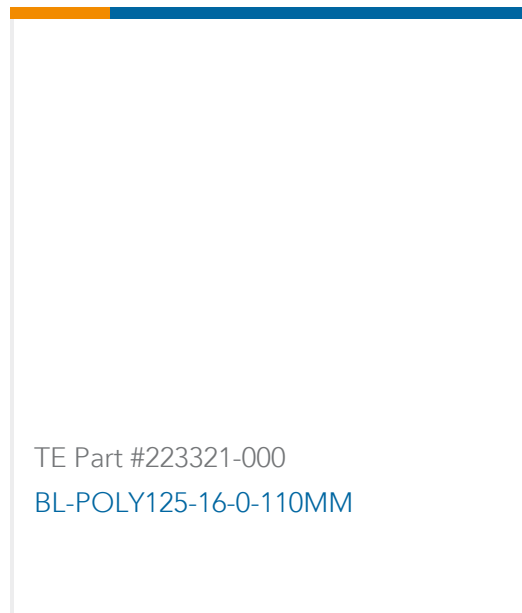

Documents

Product Drawings

[2POS MQS REC SEALED COD A](#)

English

CAD Files

[3D PDF](#)

3D

Customer View Model

[ENG_CVM_CVM_284703-1_D.2d_dxf.zip](#)

English

Customer View Model

[ENG_CVM_CVM_284703-1_D.3d_igs.zip](#)

English

Customer View Model

[ENG_CVM_CVM_284703-1_D.3d_stp.zip](#)

English

By downloading the CAD file I accept and agree to the [Terms and Conditions](#) of use.

Datasheets & Catalog Pages

[Micro Quadlok Interconnection System \(MQS\)](#)

English

Product Specifications

[2 Positions Micro Quadlok System sealed connector](#)

English

Instruction Sheets

[2 POS. MICRO QUADLOK SYSTEM SEALED SOCKET CONNECTOR](#)

English

[Instruction Sheet \(non U.S.\)](#)

English