

SERIES: PST50W | DESCRIPTION: DC-DC CONVERTER
FEATURES

- 50 W isolated output
- certified to IEC/EN 62368, reinforced insulation
- meets EN 50155 and EN 45545-2
- 8:1 input range, 9.5 ~ 75 Vdc
- built-in EMI filter and baseplate
- wide operating temperature range (-40 ~ 105 °C)
- remote on/off
- short circuit, over current, over voltage, over temperature, & UVLO protections

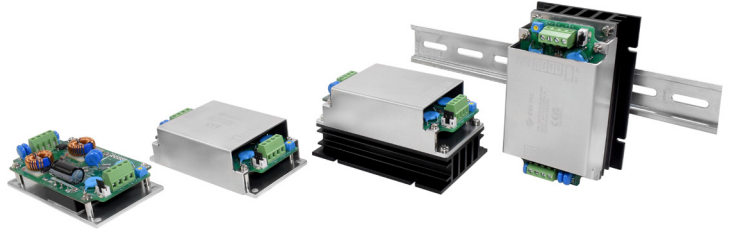

MODEL	input voltage range	output voltage	output current max	output power max	ripple and noise ¹ max	efficiency typ
	(Vdc)	(Vdc)	(A)	(W)	(mVp-p)	(%)
PST50W-36-S12B	9.5~75	12	4.17	50	150	90
PST50W-36-S15B	9.5~75	15	3.33	50	150	90
PST50W-36-S24B	9.5~75	24	2.08	50	240	90
PST50W-36-S28B	9.5~75	28	1.79	50	240	90
PST50W-36-S48B	9.5~75	48	1.05	50	480	90

Note: 1. Ripple and noise are measured peak to peak at full load, 5 ~20 MHz BW with 1µF ceramic capacitor, full load.
 2. All specifications are measured at Ta=25°C, nominal input voltage and full output load unless otherwise specified.

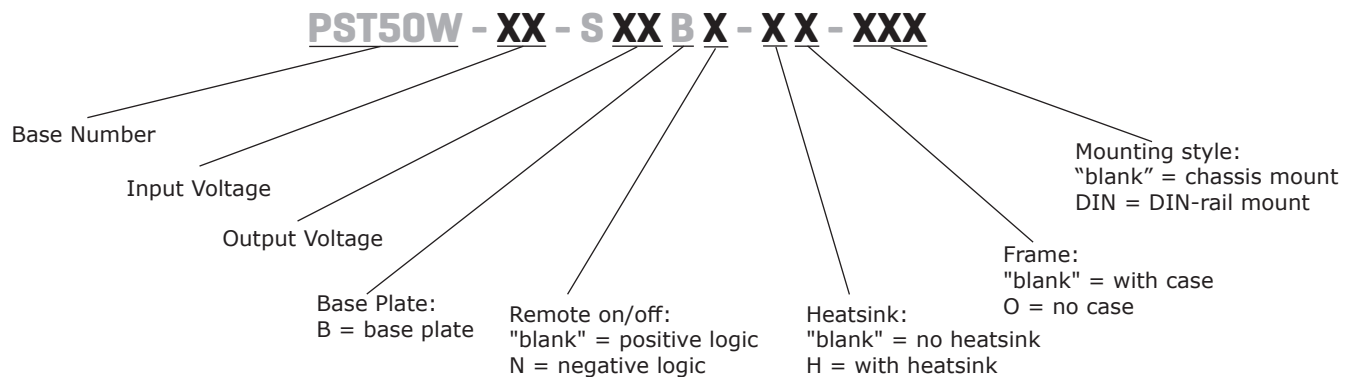
PART NUMBER KEY

INPUT

parameter	conditions/description	min	typ	max	units	
operating input voltage		9.5	36	75	Vdc	
under voltage shutdown	turn-on voltage threshold, at full load	8.4	8.8	9.3	Vdc	
	turn-off voltage threshold, at full load	7.5	7.9	8.4	Vdc	
hysteresis voltage shutdown	at full load		0.9		Vdc	
maximum input current	at full load, 9.5 Vdc input voltage		7.5		A	
input current (no load/full load)	Vin=36V, Io=0A					
	12 Vdc output models		10/1,544		mA	
	15 Vdc output models		10/1,542		mA	
	24 Vdc output models		12/1,541		mA	
	28 Vdc output models		12/1,547		mA	
remote on/off	positive logic	models ON: V_{remote} at $I_{remote} = 0.0\mu A$, Pin open = on	4.0		75	Vdc
		models OFF: V_{remote} at $I_{remote} = 1.0mA$	0		1.0	Vdc
	negative logic	models ON: V_{remote} at $I_{remote} = 1.0mA$	0		1.0	Vdc
		models OFF: V_{remote} at $I_{remote} = 0.0\mu A$, Pin open = off	4.0		75	Vdc
remote on/off current ³	I_{remote} at $V_{remote} = 0V$		0.3	1	mA	
leakage current ³	logic high, $V_{remote} = 15V$			30	μA	
off converter current			5	10	mA	

Note: 3. For positive and negative logic.

OUTPUT

parameter	conditions/description	min	typ	max	units
maximum capacitive load	12 Vdc output models			8,000	μF
	15 Vdc output models			6,800	μF
	24, 28 Vdc output models			2,350	μF
	48 Vdc output models			700	μF
line regulation	measured from high line to low line			± 0.2	%
load regulation	measured from full load to zero load			± 0.2	%
voltage accuracy	at full load, 36 Vdc input voltage, 25°C		± 1		%
switching frequency		180	200	220	kHz
transient response	75 ~ 100% step load change			250	μs
temperature coefficient	40 ~ 105°C			± 0.02	%/°C
remote on/off start-up time ⁴	V_{remote} to 10% V_{o_set} , remote on		20		ms
input start-up time ⁴	V_{in_min} to 10% V_{o_set} , power up		20		ms
rise time	10% V_{o_set} to 90% V_{o_set}		10		ms
voltage trim range	$P_o \leq \text{max rated power}$, $I_o \leq I_{o_max}$	-20		15	%
remote sense range	$P_o \leq \text{max rated power}$, $I_o \leq I_{o_max}$ % of nominal V_o			15	%

Note: 4. At full constant resistive load.

PROTECTIONS

parameter	conditions/description	min	typ	max	units
over current protection	auto recovery, hiccup	110	150	210	%
over voltage protection	limited voltage, % of nominal V_o	117	125	140	%
short circuit protection	auto recovery, continuous				
over temperature protection ⁵	shutdown		110		°C
	restart threshold		100		°C

Note: 5. Temperature at the center part of base plate, non-latching.

SAFETY AND COMPLIANCE

parameter	conditions/description	min	typ	max	units
isolation voltage	input to output, for 1 minute			3,000 4,200	Vac Vdc
	input to case (base plate), for 1 minute			2,100 3,000	Vac Vdc
	output to case (base plate), for 1 minute			1,500 2,100	Vac Vdc
isolation resistance	input to output	100			MΩ
isolation capacitance	input to output		15,000		pF
	input to case (base plate)		16,000		pF
	output to case (base plate)		23,000		pF
safety approvals	certified to 62368-1: IEC, EN designed to meet 62368-1: UL				
conducted emissions	EN 55032 and EN 50155 compliant, class A				
radiated emissions	EN 55032 and EN 50155 compliant, class A				
ESD	EN 61000-4-2 Level 3: Air ±8kV, Contact ±6kV, perf. criteria A				
radiated immunity	EN 61000-4-3 Level 3: 80~1000MHz, 20V/m, perf. criteria A				
surge	EN 61000-4-5 Level 4: Line to earth, ±4kV, Line to line, ±2kV, perf. criteria A				
conducted immunity	EN 61000-4-6 Level 3: 0.15~80MHz, 10V, perf. criteria A				
MTBF	as per MIL-HDBK-217F, 25°C				
	12 Vdc output models		561,000		hours
	15, 24 Vdc output models		612,000		hours
	28 Vdc output models		603,000		hours
48 Vdc output models		610,000		hours	
RoHS	yes				

ENVIRONMENTAL

parameter	conditions/description	min	typ	max	units
operating temperature	see derating curve	-40		105	°C
storage temperature		-40		105	°C
humidity	non condensing	-		95	%
operating altitude			5,000		m

MECHANICAL

parameter	conditions/description	min	typ	max	units
base plate material	aluminum				
potting material	UL 94V-0 (DC Module)				
dimensions	without case: 4.60 x 2.40 x 1.46 [116.8 x 61.0 x 37.0 mm]				inch
	with case: 4.60 x 2.49 x 1.46 [116.8 x 63.4 x 37.0 mm]				inch
	with case & heatsink: 4.60 x 2.49 x 2.40 [116.8 x 63.4 x 61.0 mm]				inch
	with case, heatsink & DIN rail: 4.60 x 2.49 x 3.02 [116.8 x 63.4 x 76.7 mm]				inch
weight	without case		215		g
	with case		250		g
	with case & heatsink		470		g
	with case, heatsink, & DIN rail		490		g

MECHANICAL DRAWING

units: inch[mm]

general tolerance: inches: x.xx = ±0.02, x.xxx = ±0.010

millimeters: x.x = ±0.5, x.xx = ±0.25

PIN CONNECTIONS CN1 & CN2

PIN	FUNCTION
1	+Vin
2	-Vin
3	remote
4	case
5	+Vout
6	+Vout
7	-Vout
8	-Vout

PIN CONNECTIONS CN3

PIN	FUNCTION
1	-Vout
2	-sense
3	+sense
4	+Vout

* JP1: Short PIN1 & PIN2

* JP2: Short PIN3 & PIN4

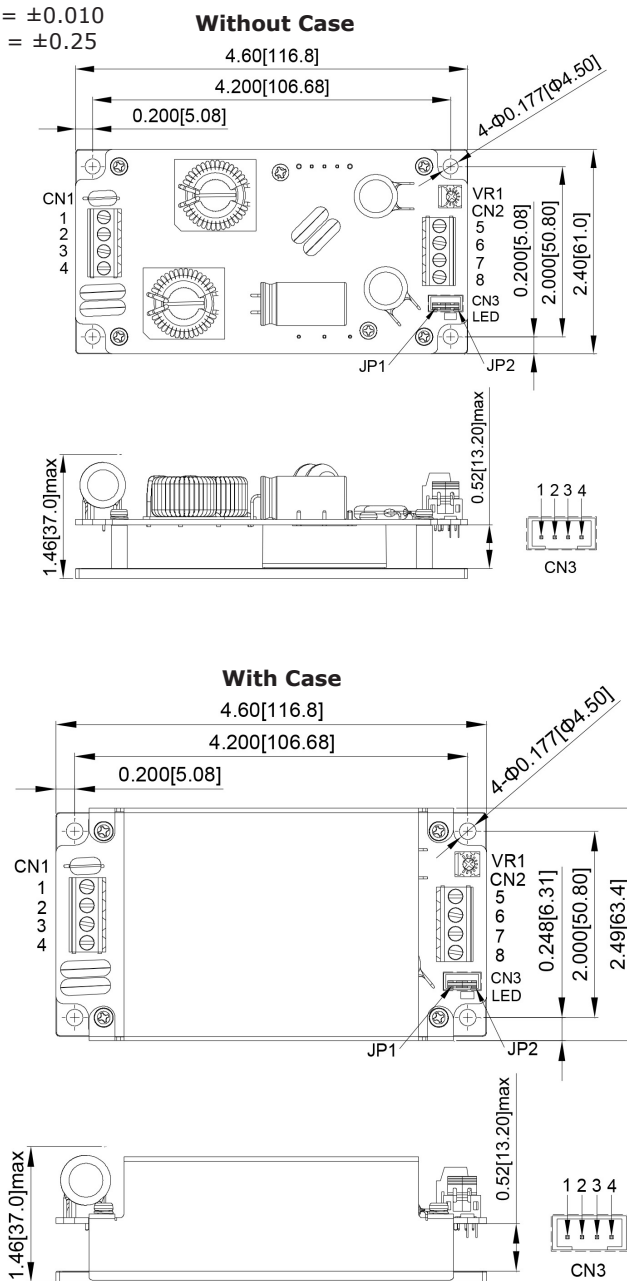

MECHANICAL DRAWING

units: inch[mm]

general tolerance: inches: x.xx = ±0.02, x.xxx = ±0.010

millimeters: x.x = ±0.5, x.xx = ±0.25

PIN CONNECTIONS CN1 & CN2	
PIN	FUNCTION
1	+Vin
2	-Vin
3	remote
4	case
5	+Vout
6	+Vout
7	-Vout
8	-Vout

PIN CONNECTIONS CN3	
PIN	FUNCTION
1	-Vout
2	-sense
3	+sense
4	+Vout

* JP1: Short PIN1 & PIN2

* JP2: Short PIN3 & PIN4

With Case and Heatsink

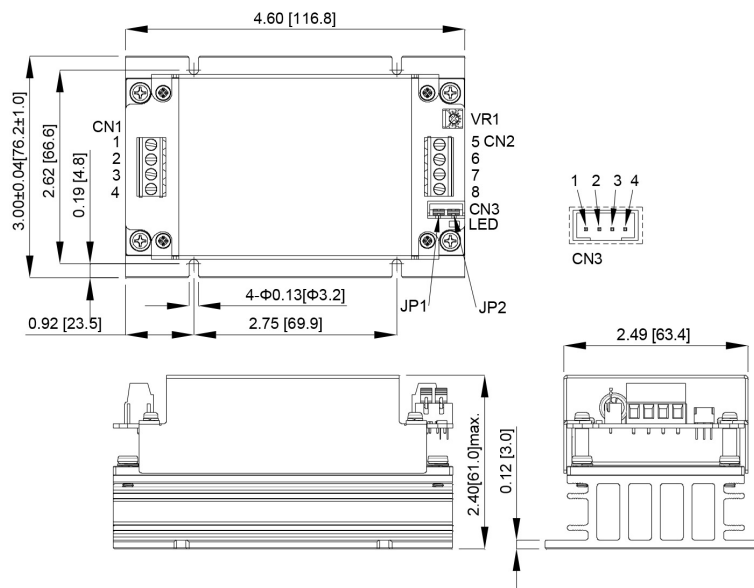

With Case, Heatsink, and DIN rail

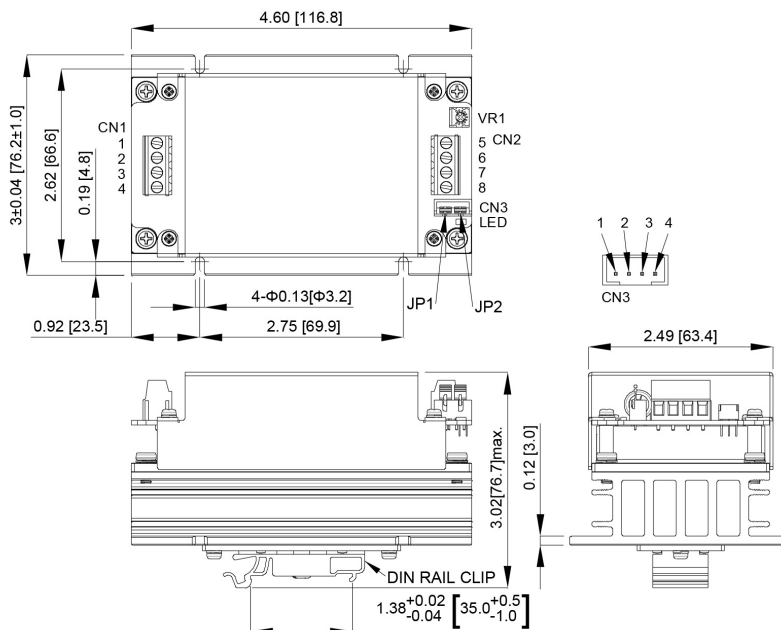

DERATING CURVES

**TEMPERATURE DERATING CURVE
with heatsink (Vin = 36V)**

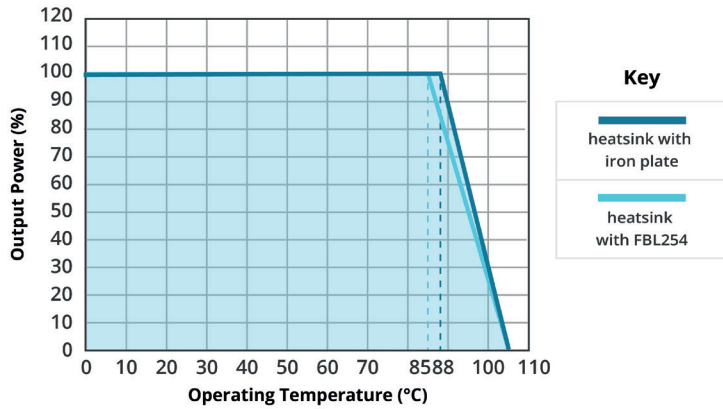

**TEMPERATURE DERATING CURVE
with heatsink (Vin = 36V)**

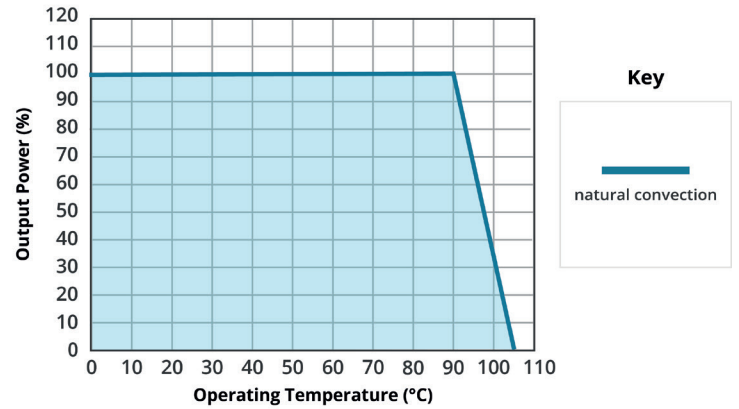

EFFICIENCY CURVES

**EFFICIENCY VS OUTPUT POWER
PST50W-36-S12B (at 25°C)**

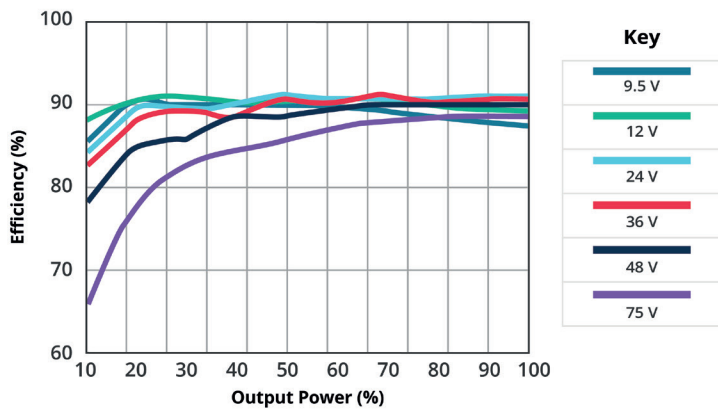

**POWER DISSIPATION VS OUTPUT POWER
PST50W-36-S12B (at 25°C)**

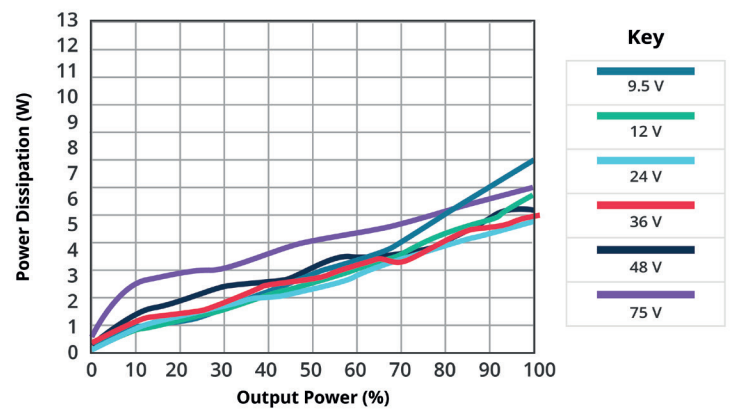

**EFFICIENCY VS OUTPUT POWER
PST50W-36-S15B (at 25°C)**

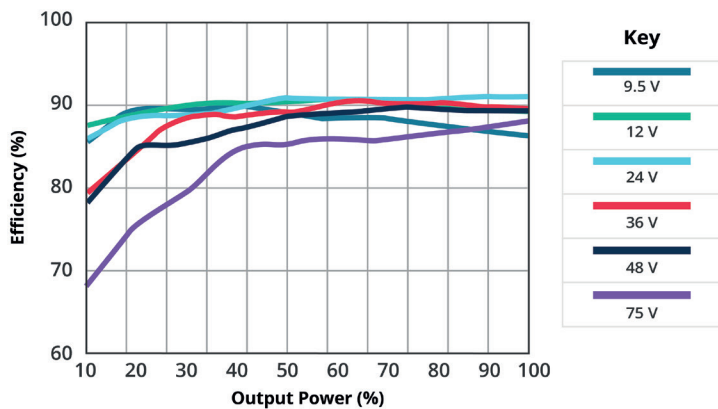

**POWER DISSIPATION VS OUTPUT POWER
PST50W-36-S15B (at 25°C)**

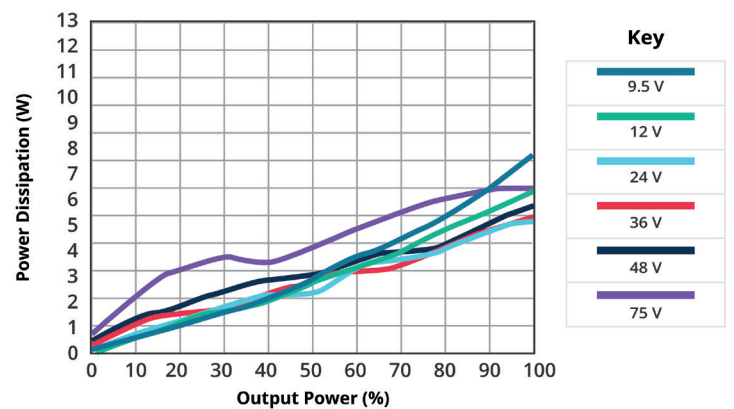

EFFICIENCY CURVES (CONTINUED)

EFFICIENCY VS OUTPUT POWER
PST50W-36-S24B (at 25°C)

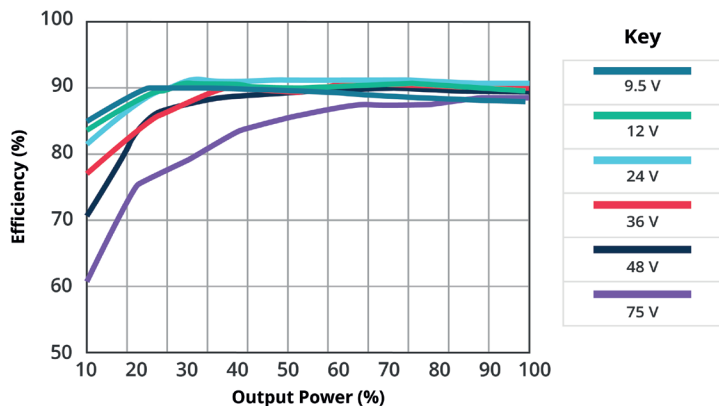

POWER DISSIPATION VS OUTPUT POWER
PST50W-36-S24B (at 25°C)

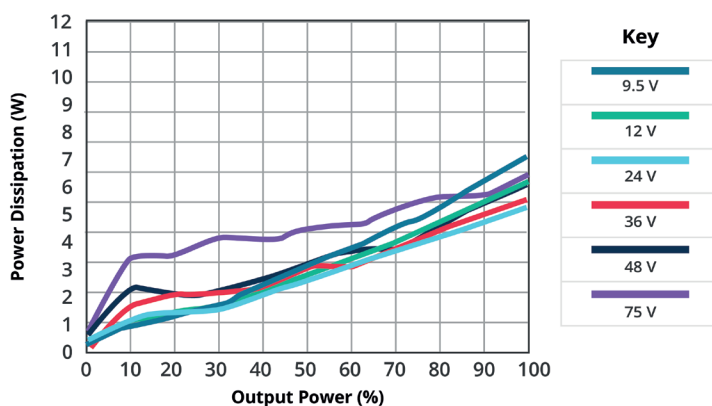

EFFICIENCY VS OUTPUT POWER
PST50W-36-S28B (at 25°C)

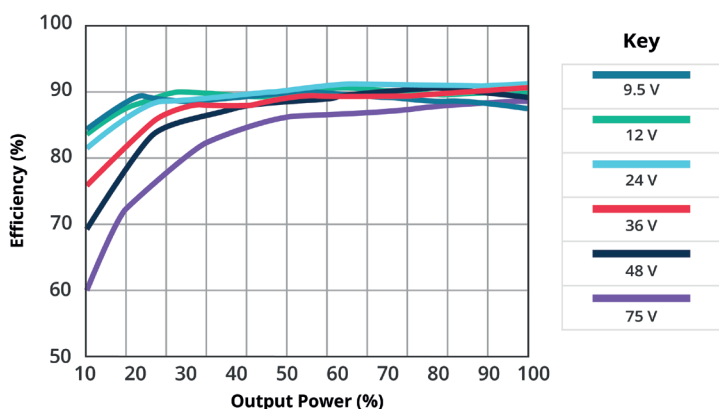

POWER DISSIPATION VS OUTPUT POWER
PST50W-36-S28B (at 25°C)

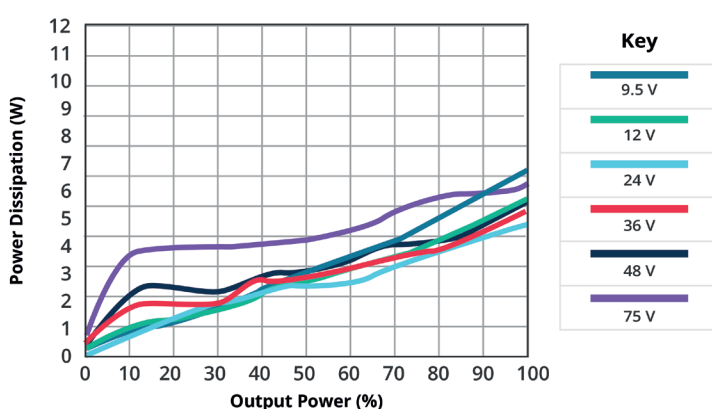

EFFICIENCY VS OUTPUT POWER
PST50W-36-S48B (at 25°C)

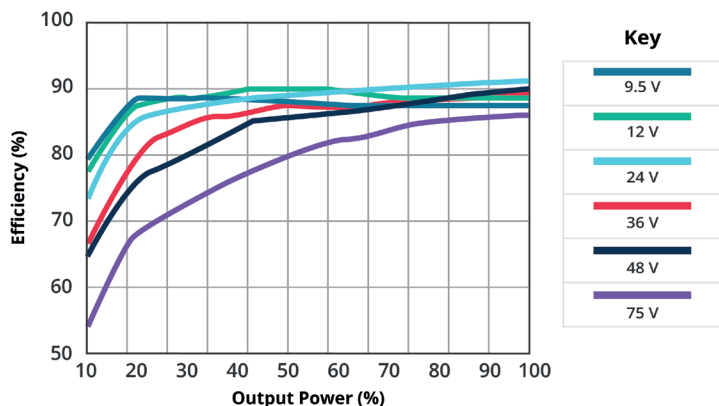

POWER DISSIPATION VS OUTPUT POWER
PST50W-36-S48B (at 25°C)

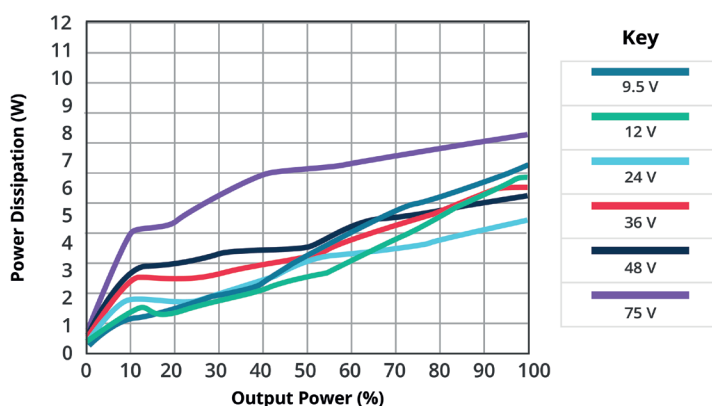

REVISION HISTORY

rev.	description	date
1.0	initial release	02/10/2024

The revision history provided is for informational purposes only and is believed to be accurate.



CUI INC
a bel group

Headquarters
20050 SW 112th Ave.
Tualatin, OR 97062
800.275.4899

Fax 503.612.2383
cui.com
techsupport@cui.com

CUI offers a two (2) year limited warranty. Complete warranty information is listed on our website.

CUI reserves the right to make changes to the product at any time without notice. Information provided by CUI is believed to be accurate and reliable. However, no responsibility is assumed by CUI for its use, nor for any infringements of patents or other rights of third parties which may result from its use.

CUI products are not authorized or warranted for use as critical components in equipment that requires an extremely high level of reliability. A critical component is any component of a life support device or system whose failure to perform can be reasonably expected to cause the failure of the life support device or system, or to affect its safety or effectiveness.