

Key Parameters

V_{DRM} / V_{RRM}	1600V
I_{TAVM}	2170A ($T_C=85\text{ °C}$)
I_{TSM}	44000A
V_{TO}	0,90V
r_T	0,106m Ω
R_{thJC}	12,6 K/kW
Clamping Force	30...45kN
Max. Diameter	111 mm
Contact Diameter	65 mm
Height	26,5 mm



For type designation please refer to actual short form catalog

<http://www.ifbip.com/catalog>

Merkmale

- Volle Sperrfähigkeit 50/60Hz über einen weiten Temperaturbereich
- Hohe DC Sperrstabilität
- Hohe Stoßstrombelastbarkeit
- Industrie-Standard-Gehäuse

Features

- Full blocking 50/60Hz over a wide range temperature range
- High DC blocking stability
- High surge current capability
- Industrial standard package

Typische Anwendungen

- Sanftanlasser
- UPS Bypass
- Gleichrichter für Antriebsapplikationen

Typical Applications

- Soft starter
- UPS Bypass
- Rectifier for drives applications



content of customer DMX code	DMX code digit	DMX code digit quantity
serial number	1..7	7
SP material number	8..16	9
datecode (production day)	17..18	2
datecode (production year)	19..20	2
datecode (production month)	21..22	2
vT class (optional)	23..26	4
QR class (optional)	27..30	4

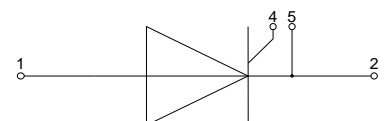

www.ifbip.com
support@infineon-bip.com

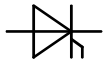

Elektrische Eigenschaften / Electrical properties
Höchstzulässige Werte / Maximum rated values

Periodische Vorwärts- und Rückwärts-Spitzensperrspannung repetitive peak forward off-state and reverse voltages	$T_{vj} = -40^{\circ}\text{C} \dots T_{vj \max}$	$V_{\text{DRM}}, V_{\text{RRM}}$	1600	V
Vorwärts-Stosspitzensperrspannung non-repetitive peak forward off-state voltage	$T_{vj} = -40^{\circ}\text{C} \dots T_{vj \max}$	V_{DSM}	1600	V
Rückwärts-Stosspitzensperrspannung non-repetitive peak reverse voltage	$T_{vj} = +25^{\circ}\text{C} \dots T_{vj \max}$	V_{RSM}	1700	V
Durchlassstrom-Grenzeffektivwert maximum RMS on-state current	$T_C = 85^{\circ}\text{C}$	I_{TRMS}	3400	A
Dauergrenzstrom average on-state current	$T_C = 85^{\circ}\text{C}$	I_{TAVM}	2170	A
Dauergrenzstrom average on-state current	$T_C = 55^{\circ}\text{C}, \theta = 180^{\circ}\sin, t_p = 10\text{ms}$	I_{TAVM}	3200	A
Durchlaßstrom-Effektivwert RMS on-state current		I_{TRMS}	5020	A
Stossstrom-Grenzwert surge current	$T_{vj} = 25^{\circ}\text{C}, t_p = 10\text{ms}$ $T_{vj} = T_{vj \max}, t_p = 10\text{ms}$	I_{TSM}	44000 44000	A A
Grenzlastintegral I^2t -value	$T_{vj} = 25^{\circ}\text{C}, t_p = 10\text{ms}$ $T_{vj} = T_{vj \max}, t_p = 10\text{ms}$	I^2t	9680 9680	$10^3 \text{ A}^2\text{s}$ $10^3 \text{ A}^2\text{s}$
Kritische Stromsteilheit critical rate of rise of on-state current	DIN IEC 60747-6 $f = 50\text{Hz}, i_{\text{GM}} = 1\text{A}, di_{\text{G}}/dt = 1\text{A}/\mu\text{s}$	$(di_{\text{T}}/dt)_{\text{cr}}$	200	$\text{A}/\mu\text{s}$
Kritische Spannungssteilheit critical rate of rise of off-state voltage	$T_{vj} = T_{vj \max}, V_{\text{D}} = 0,67 V_{\text{DRM}}$ 5.Kennbuchstabe / 5 th letter F	$(dv_{\text{D}}/dt)_{\text{cr}}$	1000	$\text{V}/\mu\text{s}$

Charakteristische Werte / Characteristic values

Durchlassspannung on-state voltage	$T_{vj} = T_{vj \max}, i_{\text{T}} = 3\text{kA}$	v_{T}	max. 1,24	V
Schleusenspannung threshold voltage	$T_{vj} = T_{vj \max}$	$V_{(\text{TO})}$	max 0,90	V
Ersatzwiderstand slope resistance	$T_{vj} = T_{vj \max}$	r_{T}	max 0,106	$\text{m}\Omega$
Durchlasskennlinie on-state characteristic $v_{\text{T}} = A + B \cdot i_{\text{T}} + C \cdot \ln(i_{\text{T}} + 1) + D \cdot \sqrt{i_{\text{T}}}$	$T_{vj} = T_{vj \max}$	A= B= C= D=	5,144E-01 7,253E-05 4,900E-02 2,238E-03	
Zündstrom gate trigger current	$T_{vj} = 25^{\circ}\text{C}, V_{\text{D}} = 12\text{V}$	I_{GT}	max. 250	mA
Zündspannung gate trigger voltage	$T_{vj} = 25^{\circ}\text{C}, V_{\text{D}} = 12\text{V}$	V_{GT}	max. 2	V
Nicht zündender Steuerstrom gate non-trigger current	$T_{vj} = T_{vj \max}, V_{\text{D}} = 12\text{V}$ $T_{vj} = T_{vj \max}, V_{\text{D}} = 0,5 V_{\text{DRM}}$	I_{GD}	max. 10 max. 5	mA mA
Nicht zündende Steuerspannung gate non-trigger voltage	$T_{vj} = T_{vj \max}, V_{\text{D}} = 0,5 V_{\text{DRM}}$	V_{GD}	max. 0,2	V
Haltestrom holding current	$T_{vj} = 25^{\circ}\text{C}, V_{\text{D}} = 12\text{V}$	I_{H}	max. 300	mA
Einraststrom latching current	$T_{vj} = 25^{\circ}\text{C}, V_{\text{D}} = 12\text{V}, R_{\text{GK}} \geq 10\Omega$ $i_{\text{GM}} = 1\text{A}, di_{\text{G}}/dt = 1\text{A}/\mu\text{s},$ $t_{\text{g}} = 20 \mu\text{s}$	I_{L}	max. 1500	mA
Vorwärts- und Rückwärts-Sperrstrom forward off-state and reverse current	$T_{vj} = T_{vj \max}$ $V_{\text{D}} = V_{\text{DRM}}, V_{\text{R}} = V_{\text{RRM}}$	$i_{\text{D}}, i_{\text{R}}$	max. 250	mA
Zündverzug gate controlled delay time	DIN IEC 60747-6 $T_{vj} = 25^{\circ}\text{C}, i_{\text{GM}} = 1\text{A},$ $di_{\text{G}}/dt = 1\text{A}/\mu\text{s}$	t_{gd}	max. 4	μs

prepared by:	HR	date of publication:	2023-10-06
approved by:	MS	revision:	3.1

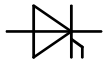

Technische Information /
technical information



**Netz-Thyristor
Phase Control Thyristor**

T2200N16H100

Infineon Technologies Bipolar
GmbH & Co. KG

Elektrische Eigenschaften / Electrical properties
Charakteristische Werte / Characteristic values

Freiwerdezeit circuit commutated turn-off time	$T_{vj} = T_{vj,max}, i_{TM} = I_{TAVM}$ $V_{RM} = 100\text{ V}, V_{DM} = 0,67 V_{DRM}$ $dv_D/dt = 20\text{ V}/\mu\text{s}, -di_T/dt = 10\text{ A}/\mu\text{s}$ 4.Kennbuchstabe / 4 th letter O	t_q	typ. 250	μs
---	---	-------	----------	---------------

Thermische Eigenschaften / Thermal properties

Innerer Wärmewiderstand thermal resistance, junction to case	<u>Kühlfläche / cooling surface</u> beidseitig / two-sided, $\theta = 180^\circ\text{sin}$ beidseitig / two-sided, DC Anode / anode, $\theta = 180^\circ\text{sin}$ Anode / anode, DC Kathode / cathode, $\theta = 180^\circ\text{sin}$ Kathode / cathode, DC	R_{thJC}	max. 12,60 max. 11,70 max. max. max.	K /kW K/kW K/kW K/kW K/kW
Übergangs-Wärmewiderstand thermal resistance, case to heatsink	<u>Kühlfläche / cooling surface</u> beidseitig / two-sides einseitig / single-sides	R_{thCH}	max. 3,0 max. 6,0	K/kW K/kW
Höchstzulässige Sperrschichttemperatur maximum junction temperature		$T_{vj,max}$	125	$^\circ\text{C}$
Betriebstemperatur operating temperature		$T_{c,op}$	-40...+125	$^\circ\text{C}$
Lagertemperatur storage temperature		T_{stg}	-40...+150	$^\circ\text{C}$

Mechanische Eigenschaften / Mechanical properties

Gehäuse, siehe Anlage case, see annex			Seite 4 page 4	
Si-Element mit Druckkontakt Si-pellet with pressure contact				
Anpresskraft clamping force		F	30...45	kN
Steueranschlüsse control terminals	Gate (flat) Gate (round, based on AMP 60598) Kathode / cathode		A 2,8x0,5 \varnothing 1,5 A 4,8x0,5	mm mm mm
Gewicht weight		G	typ. 900	g
Kriechstrecke creepage distance			25	mm
Schwingfestigkeit vibration resistance	f = 50 Hz		50	m/s ²

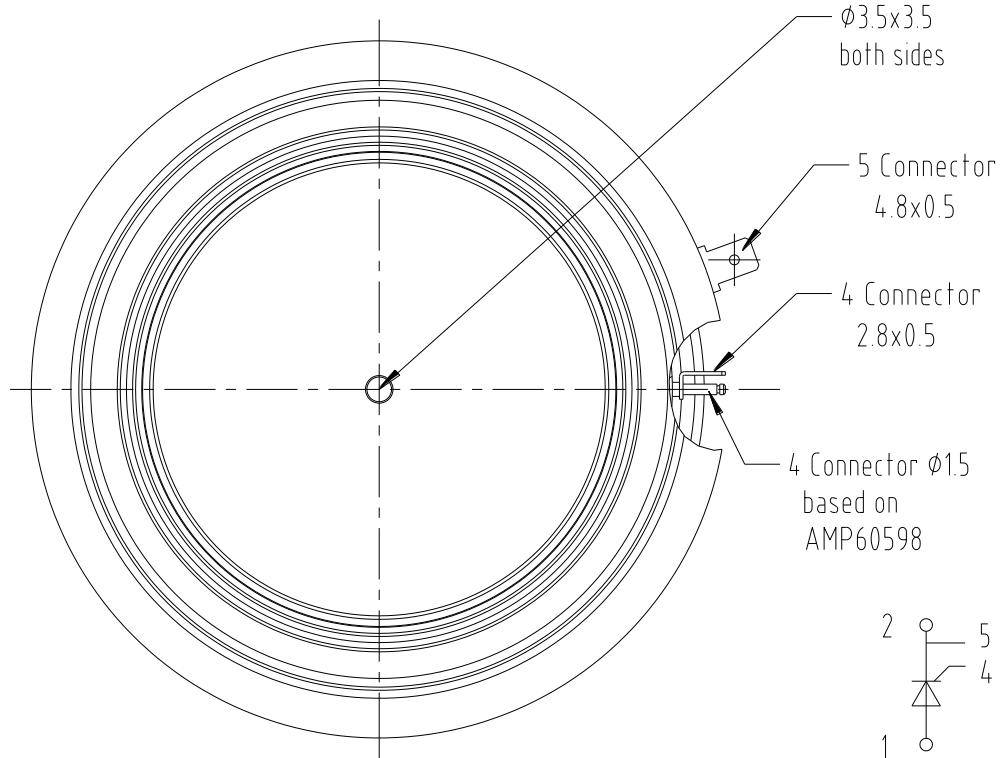
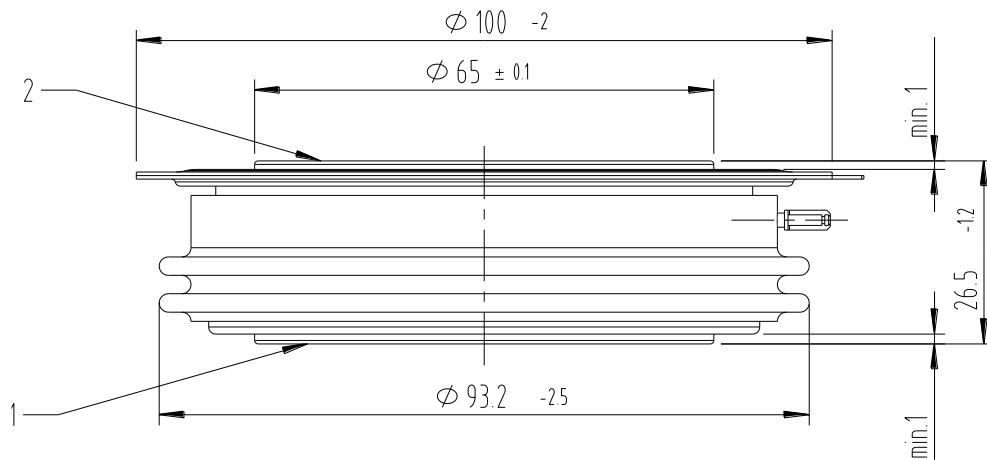
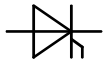

strike distance: 15mm
creepage distance: 25mm

overall height based
on contact pressure

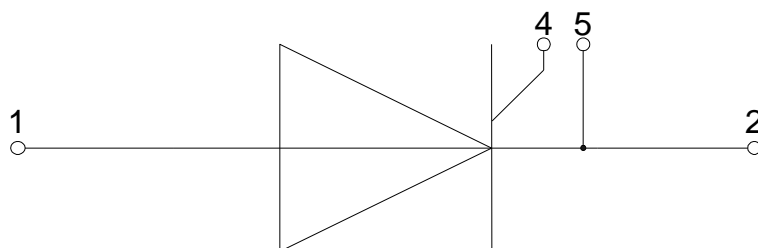

- 1: Anode / Anode**
- 2: Kathode / Cathode**
- 4: Gate**
- 5: Hilfskathode/
Auxiliary Cathode**

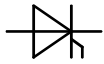

Analytische Elemente des transienten Wärmewiderstandes Z_{thJC} für DC
Analytical elements of transient thermal impedance Z_{thJC} for DC

Kühlung / Cooling	Pos. n	1	2	3	4	5	6	7
beidseitig two-sided	R_{thn} [K/kW]	2,45	5,00	2,74	0,91	0,57	0,03	0
	τ_n [s]	10	0,23	0,1	0,01	0,002	0,0003	1
anodenseitig anode-sided	R_{thn} [K/kW]							
	τ_n [s]							
kathodenseitig cathode-sided	R_{thn} [K/kW]							
	τ_n [s]							

Analytische Funktion / Analytical function:

$$Z_{thJC} = \sum_{n=1}^{n_{max}} R_{thn} \left(1 - e^{-\frac{t}{\tau_n}} \right)$$

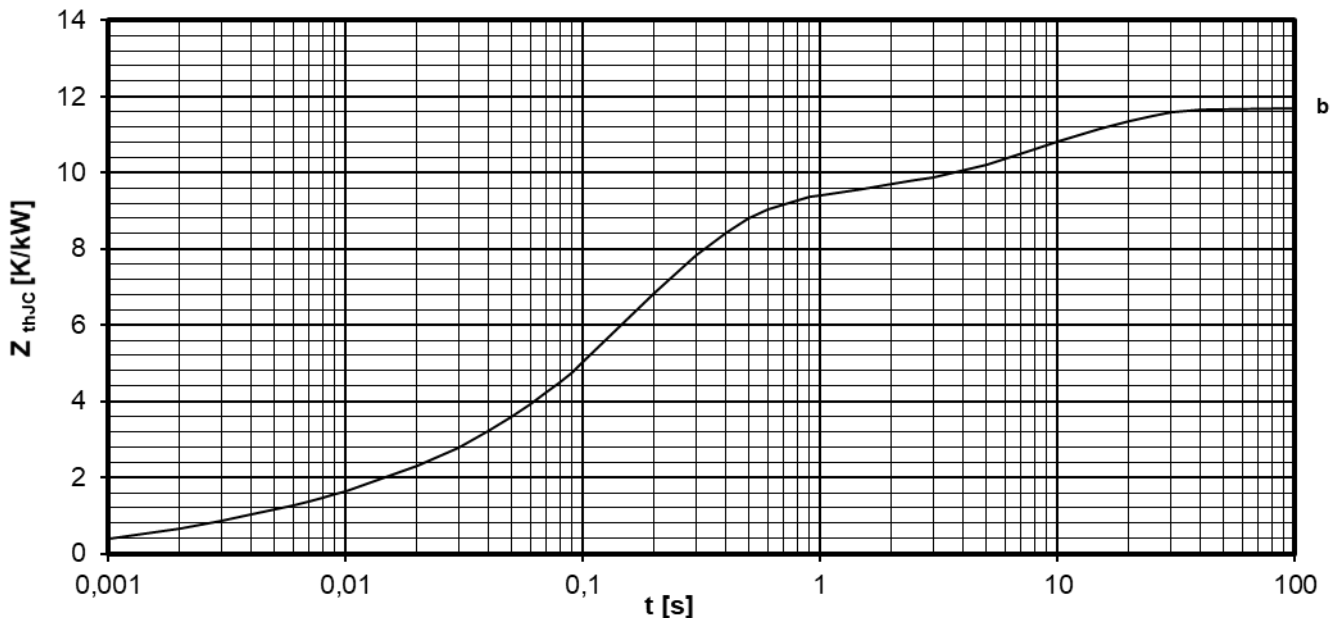

Transienter innerer Wärmewiderstand für DC / Transient thermal impedance for DC

$$Z_{thJC} = f(t)$$

- a - Anodenseitige Kühlung / Anode-sided cooling
- b - Beidseitige Kühlung / Two-sided cooling
- c - Kathodenseitige Kühlung / Cathode-sided cooling

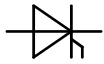

Erhöhung des $Z_{th DC}$ bei Sinus und Rechteckströmen mit unterschiedlichen Stromflusswinkeln Θ
Rise of $Z_{th DC}$ for sinewave and rectangular current with different current conduction angles Θ

$$\Delta Z_{th \Theta \sin} / \Delta Z_{th \Theta \text{ rec}}$$

Kühlung / Cooling	$\Delta Z_{th \Theta \sin 180^\circ}$ [K/kW]	$\Delta Z_{th \Theta \text{ rec } 180^\circ}$ [K/kW]	$\Delta Z_{th \Theta \text{ rec } 120^\circ}$ [K/kW]	$\Delta Z_{th \Theta \text{ rec } 90^\circ}$ [K/kW]	$\Delta Z_{th \Theta \text{ rec } 60^\circ}$ [K/kW]	$\Delta Z_{th \Theta \text{ rec } 30^\circ}$ [K/kW]
beidseitig two-sided	0,864	1,260	2,097	2,734	3,672	5,120
anodenseitig anode-sided						
kathodenseitig cathode-sided						

$$Z_{th \Theta \sin} = Z_{th DC} + \Delta Z_{th \Theta \sin}$$

$$Z_{th \Theta \text{ rec}} = Z_{th DC} + \Delta Z_{th \Theta \text{ rec}}$$

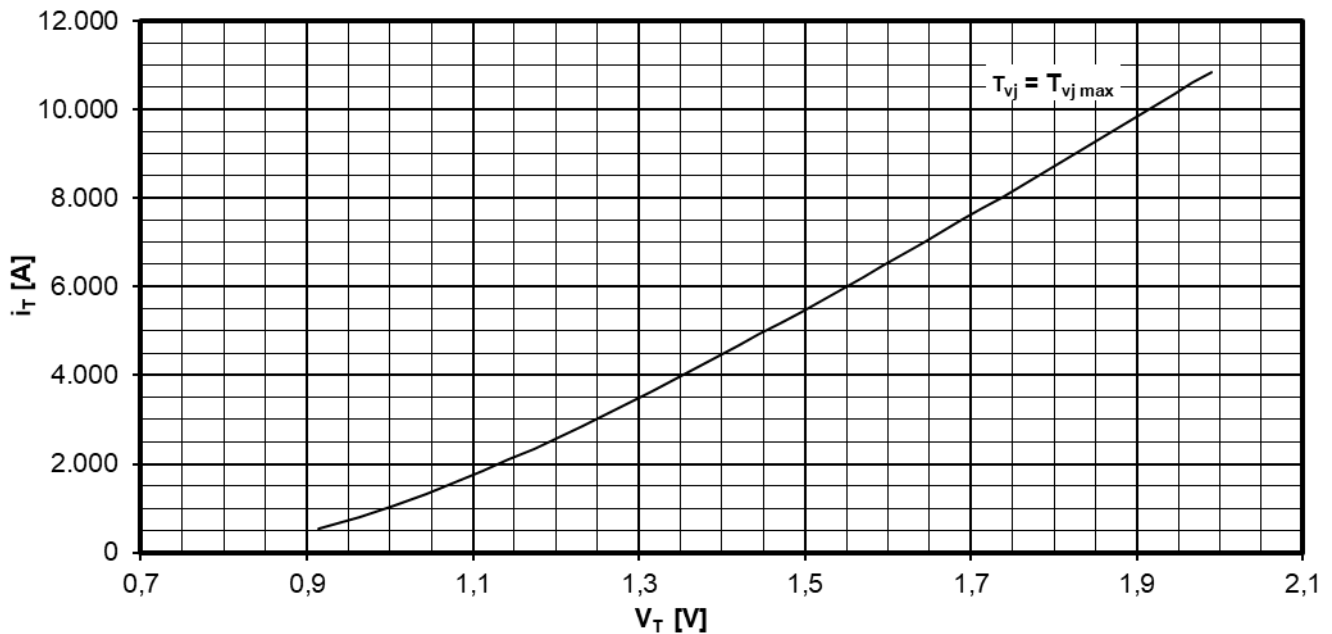

Grenzdurchlasskennlinie / Limiting on-state characteristic $i_T = f(V_T)$

$$T_{vj} = T_{vj \text{ max}}$$

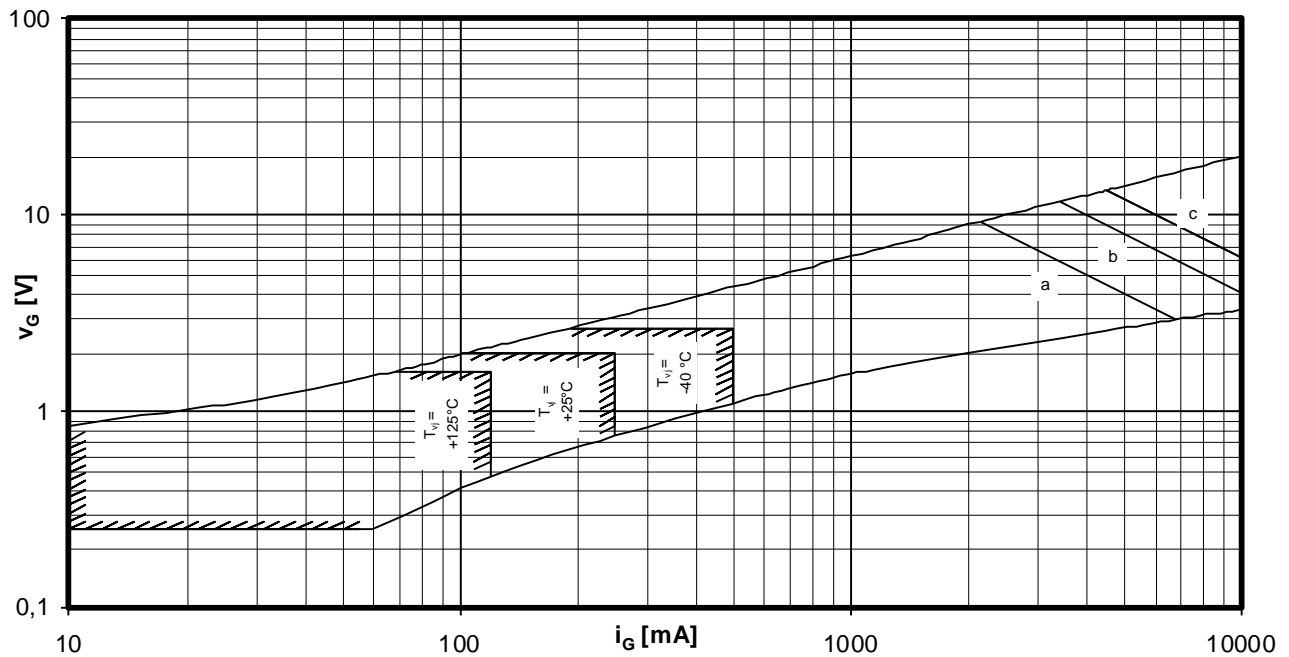
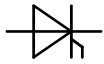

Steuercharakteristik $v_G = f(i_G)$ mit Zündbereichen für $V_D = 12\text{ V}$
Gate characteristic $v_G = f(i_G)$ with triggering area for $V_D = 12\text{ V}$

Höchstzulässige Spitzensteuerverlustleistung / Maximum rated peak gate power dissipation $P_{GM} = f(t_g)$:

a - 20W / 10ms b - 40W / 1ms c - 60W / 0,5ms

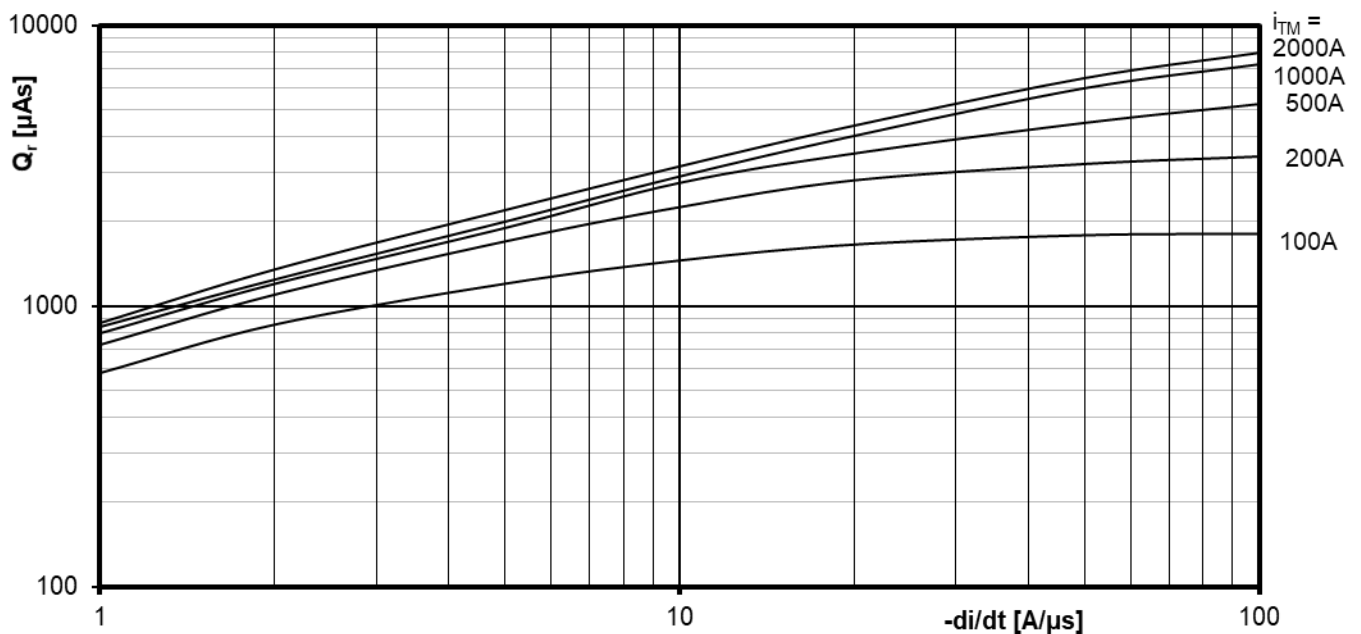

Sperrverzögerungsladung / Recovered charge $Q_r = f(di/dt)$

$T_{vj} = T_{vjmax}$, $V_R \leq 0,5 V_{RRM}$, $V_{RM} = 0,8 V_{RRM}$

Parameter: Durchlassstrom / On-state current i_{TM}

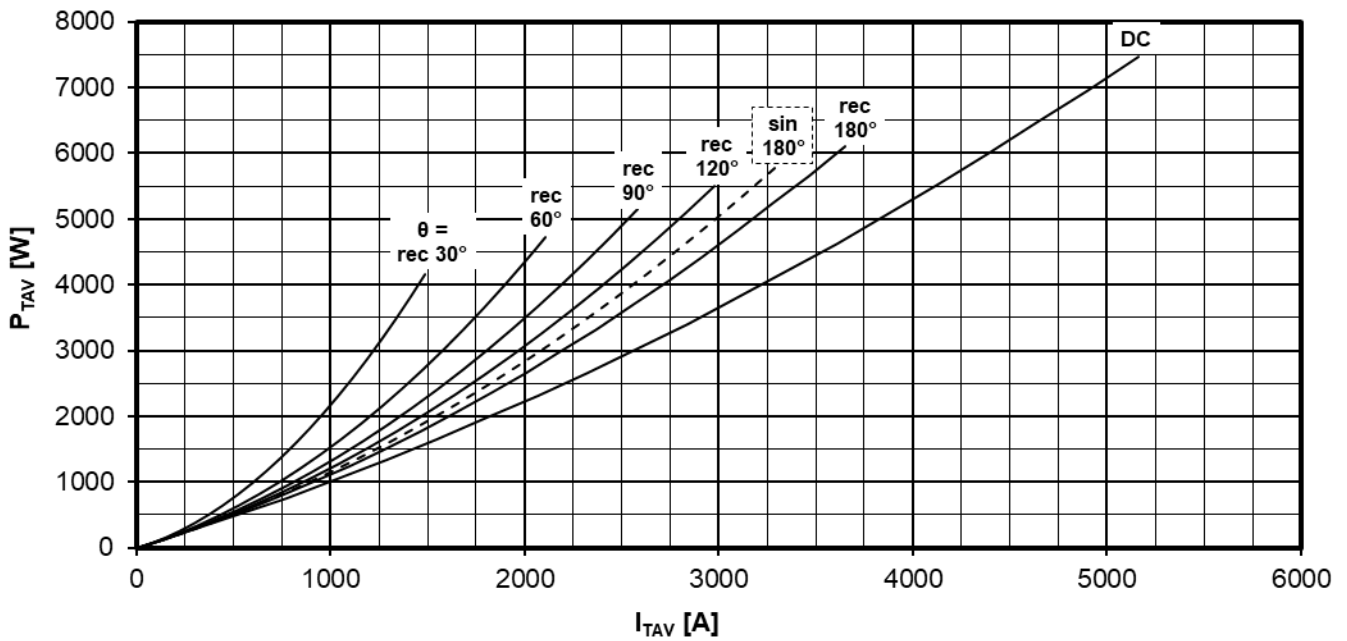
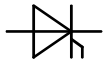

Durchlassverlustleistung / On-state power loss $P_{TAV} = f(I_{TAV})$

Parameter: Stromflusswinkel Θ / Current conduction angle Θ

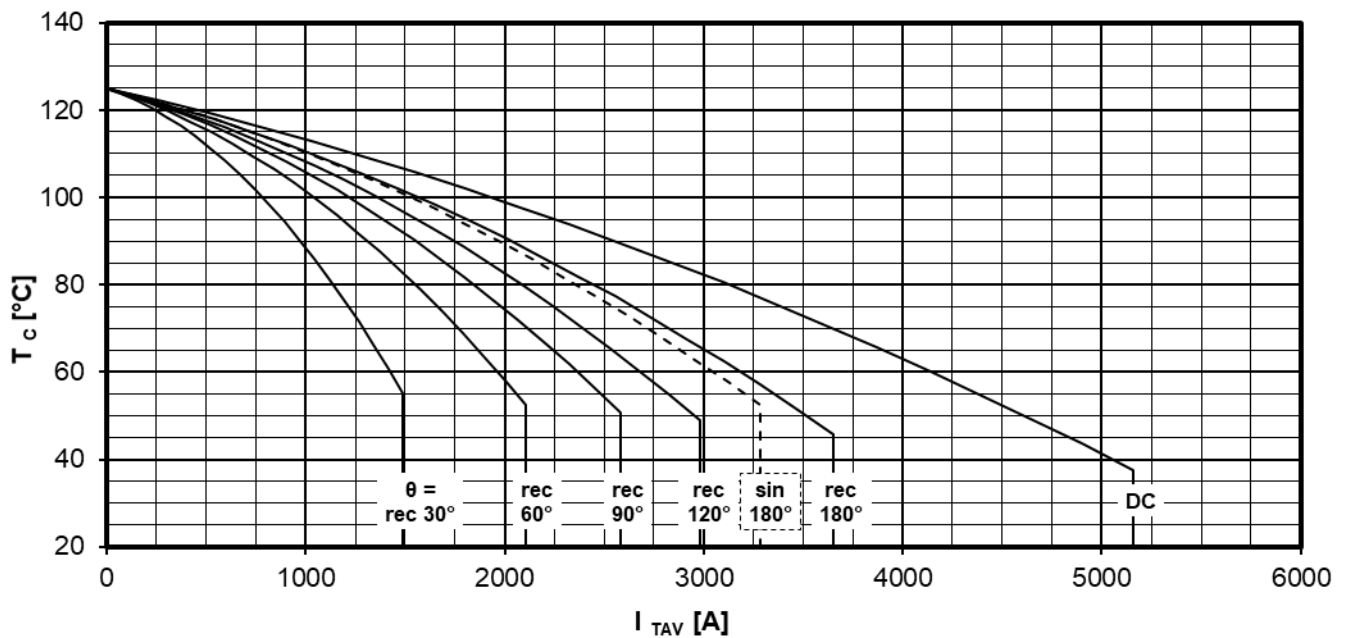

Höchstzulässige Gehäusetemperatur / Maximum allowable case temperature $T_c = f(I_{TAV})$

Beidseitige Kühlung / Two-sided cooling

Parameter: Stromflusswinkel Θ / Current conduction angle Θ

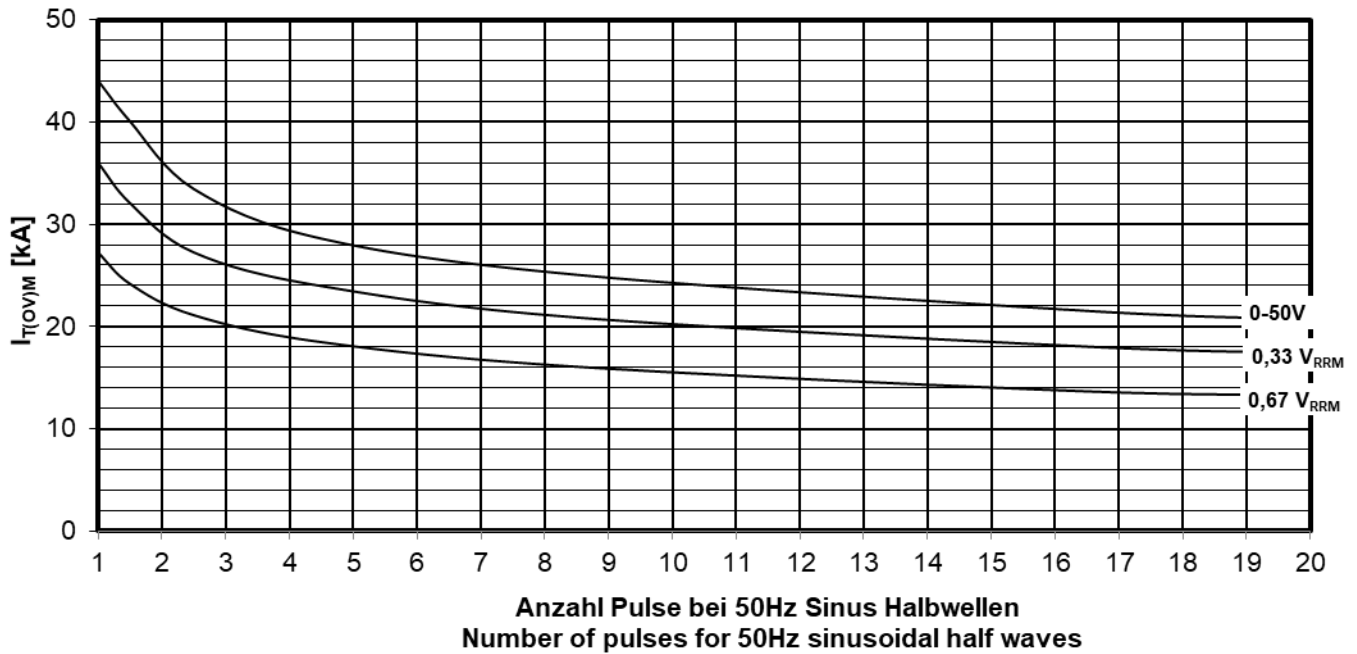
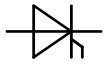

Typische Abhängigkeit des Grenzstromes $I_{T(OV)M}$ von der Anzahl für eine Folge von Sinus Halbwellen bei 50Hz. Parameter: Rückwärtsspannung V_{RM}
Typical dependency of maximum overload on-state current $I_{T(OV)M}$ as a number of a sequence of sinusoidal half waves at 50Hz. Parameter: peak reverse voltage V_{RM}
 $I_{T(OV)M} = f(\text{pulses}, V_{RM}) ; T_v = T_{vjmax}$



Nutzungsbedingungen

Die in diesem Produktdatenblatt enthaltenen Daten sind ausschließlich für technisch geschultes Fachpersonal bestimmt. Die Beurteilung der Eignung dieses Produktes für Ihre Anwendung sowie die Beurteilung der Vollständigkeit der bereitgestellten Produktdaten für diese Anwendung obliegt Ihnen bzw. Ihren technischen Abteilungen.

In diesem Produktdatenblatt werden diejenigen Merkmale beschrieben, für die wir eine liefervertragliche Gewährleistung übernehmen. Eine solche Gewährleistung richtet sich ausschließlich nach Maßgabe der im jeweiligen Liefervertrag enthaltenen Bestimmungen. Garantien jeglicher Art werden für das Produkt und dessen Eigenschaften keinesfalls übernommen.

Sollten Sie von uns Produktinformationen benötigen, die über den Inhalt dieses Produktdatenblatts hinausgehen und insbesondere eine spezifische Verwendung und den Einsatz dieses Produktes betreffen, setzen Sie sich bitte mit dem für Sie zuständigen Vertriebsbüro in Verbindung. Für Interessenten halten wir Application Notes bereit.

Aufgrund der technischen Anforderungen könnte unser Produkt gesundheitsgefährdende Substanzen enthalten. Bei Rückfragen zu den in diesem Produkt jeweils enthaltenen Substanzen setzen Sie sich bitte ebenfalls mit dem für Sie zuständigen Vertriebsbüro in Verbindung.

Sollten Sie beabsichtigen, das Produkt in gesundheits- oder lebensgefährdenden oder lebenserhaltenden Anwendungsbereichen einzusetzen, bitten wir um Mitteilung. Wir weisen darauf hin, dass wir für diese Fälle

- die gemeinsame Durchführung eines Risiko- und Qualitätsassessments;
- den Abschluss von speziellen Qualitätssicherungsvereinbarungen;
- die gemeinsame Einführung von Maßnahmen einer laufenden Produktbeobachtung dringend empfehlen und gegebenenfalls die Belieferung von der Umsetzung solcher Maßnahmen abhängig machen.

Soweit erforderlich, bitten wir Sie, entsprechende Hinweise an Ihre Kunden zu geben.

Inhaltliche Änderungen dieses Produktdatenblatts bleiben vorbehalten.

Terms & Conditions of usage

The product data contained in this product data sheet is exclusively intended for technically trained staff. You and your technical departments will have to evaluate the suitability of the product for the intended application and the completeness of the product data with respect to such application.

This product data sheet is describing the specifications of this product for which a warranty is granted. Any such warranty is granted exclusively pursuant the terms and conditions of the supply agreement. There will be no guarantee of any kind for the product and its specifications.

Should you require product information in excess of the data given in this product data sheet or which concerns the specific application of our product, please contact the sales office, which is responsible for you. For those that are specifically interested we may provide application notes.

Due to technical requirements our product may contain dangerous substances. For information on the types in question please contact the sales office, which is responsible for you.

Should you intend to use the Product in health or live endangering or life support applications, please notify. Please note, that for any such applications we urgently recommend

- to perform joint Risk and Quality Assessments;
- the conclusion of Quality Agreements;
- to establish joint measures of an ongoing product survey,
and that we may make delivery depended on the realization of any such measures.

If and to the extent necessary, please forward equivalent notices to your customers.

Changes of this product data sheet are reserved.