

Multi-layer Chip Triplexer



ATRD-R-0003

Request Samples



Check Inventory



2.0 x 1.25 x 0.90 mm
RoHS Compliant

Features

- LTCC diplexer supporting 1560 ~1606/2400~2500 / 4900~5950 MHz
- Small Form Factor 2.0 x 1.25 x 0.90 mm
- Low Insertion Loss 0.7 dB
- RoHS Compliant

Applications

- Dual-band Wi-Fi and GPS, GNSS
- Wi-Fi Speakers and Sound Bars
- Video Streaming and Network Cameras
- VR Head Mount Displays
- Car Infotainment Systems
- Broadband Gateways

Product Image

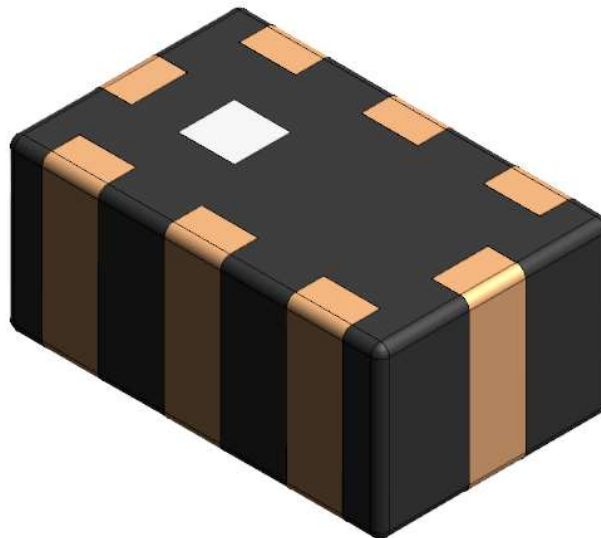

Multi-layer Chip Triplexer



ATRD-R-0003

Request Samples



Check Inventory



2.0 x 1.25 x 0.90 mm
RoHS Compliant

Electrical Specifications

Parameters	Specification			Units	Notes
Application	Low Band	Middle Band	High Band		
Insertion Loss (Max)	0.75 dB max. at 1560~1606	0.80 dB max. at 2400~2500	0.75 dB max. at 4900~5950	MHz	@25°C
Amplitude ripple at 20 MHz	0.3 dB max.	0.3 dB max.	0.3 dB max.	dB	
Min. RL in BW	12	12	12	dB	
Attenuation (Absolute value)	13 dB min. at 2400~2500 15 dB min. at 4800~6000	10 dB min. at 860~960 13 dB min. at 1545~1605 9 dB min. at 3600~3750 18 dB min. at 4800~5000 10 dB min. at 7200~7500	24 dB min. at 860~960 24 dB min. at 1545~1605 25 dB min. at 1710~1990 30 dB min. at 2170	MHz	
Isolation	15 dB min. at (LB-HB/MB-HB) 14 dB min. at LB-MB			dB	
Power Capacity	2.0 max.			W	
Characteristic Impedance	50			ohm	

Multi-layer Chip Triplexer



ATRD-R-0003

Request Samples



Check Inventory



2.0 x 1.25 x 0.90 mm
RoHS Compliant

Mechanical Specifications

Parameters	Specifications
Filter Dimension	2.0 x 1.25 x 0.90 mm
Mounting Type	SMD Mount

Environmental Specifications

Parameters	Specifications
Operating Temperature	-40°C ~ +85°C
Storage Temperature	-10°C ~ +45°C

Ordering Information

Part Identification

ATRD-R-0003



Packaging
Blank: Bulk
T: Tape & Reel



Multi-layer Chip Triplexer

ATRD-R-0003

Request Samples



Check Inventory



2.0 x 1.25 x 0.90 mm
RoHS Compliant

Package Dimensions & PCB Footprint

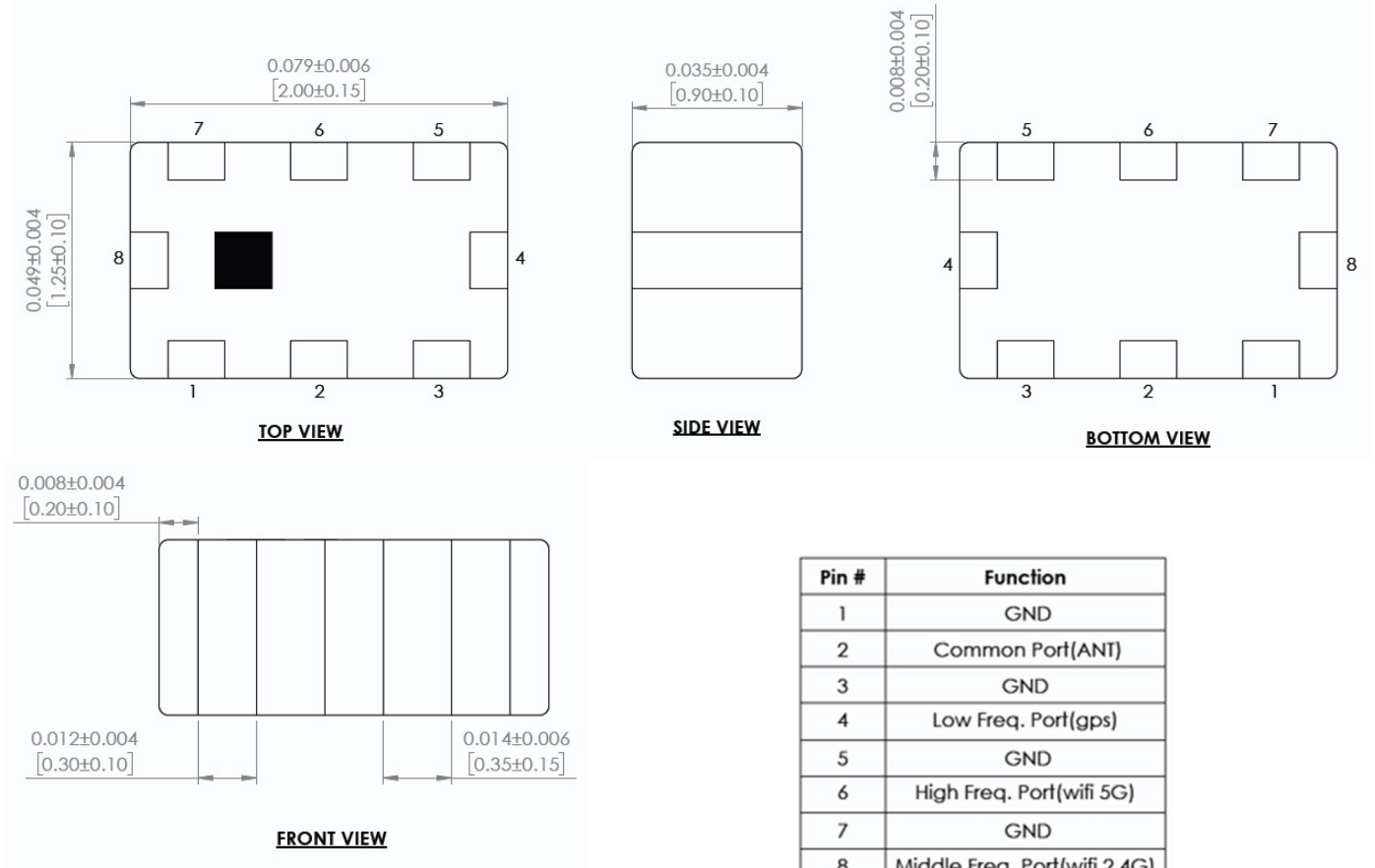

Pin #	Function
1	GND
2	Common Port(ANT)
3	GND
4	Low Freq. Port(gps)
5	GND
6	High Freq. Port(wifi 5G)
7	GND
8	Middle Freq. Port(wifi 2.4G)

DIMENSIONS: INCHES [mm]



Multi-layer Chip Triplexer

ATRD-R-0003

Request Samples







Check Inventory

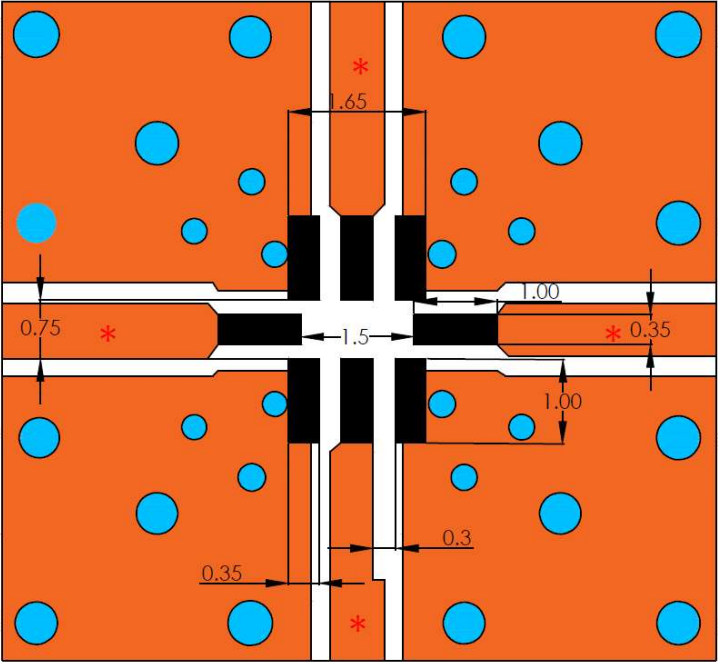

2.0 x 1.25 x 0.90 mm
RoHS Compliant

Recommended Footprint (PCB Layout)



-  Solder Resist
-  Land
-  Through-hole (Ø0.35/ 0.55)

Unit: mm

Note: Line width to be designed to match 50Ω characteristic impedance, depending on PCB material and thickness.

The transmission line is Ground Coplanar Waveguide (GCPW)



Multi-layer Chip Triplexer

ATRD-R-0003

Request Samples



Check Inventory



2.0 x 1.25 x 0.90 mm
RoHS Compliant

Frequency Characteristics

Insertion Loss 1560-1606, 2400-2500, 4900- 5950MHz

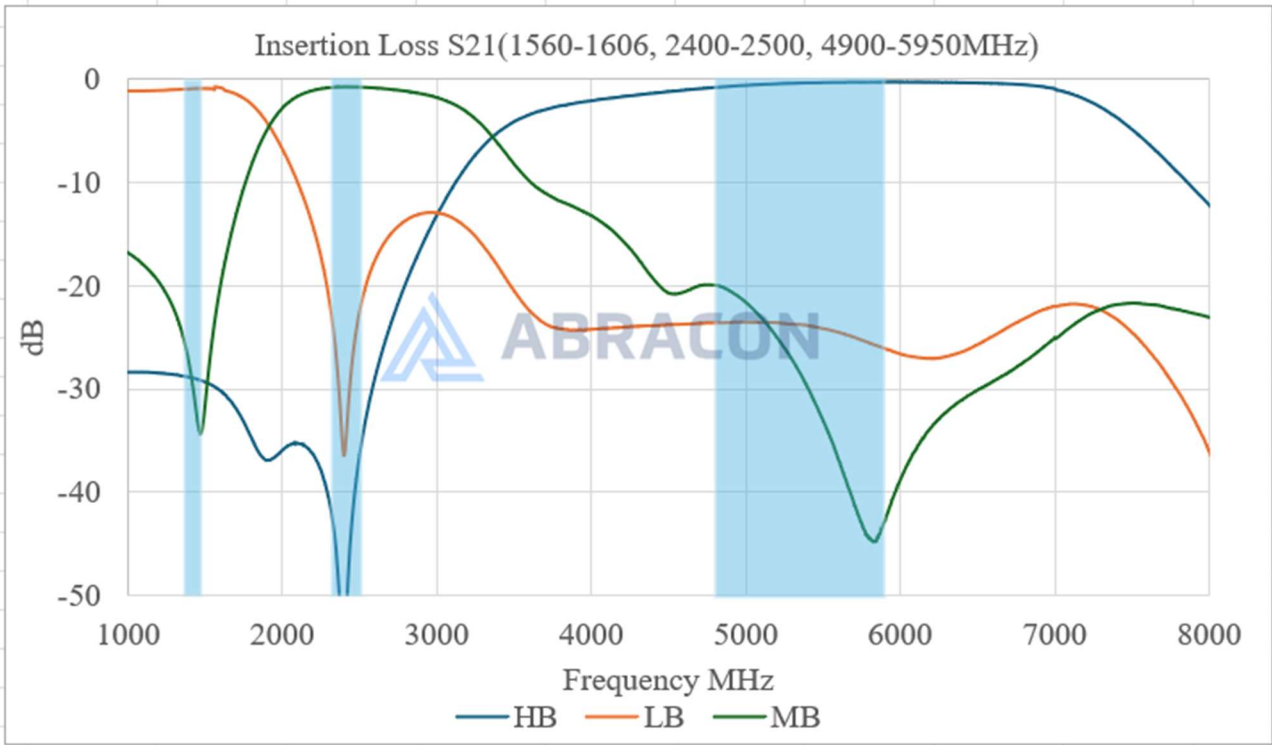

5101 Hidden Creek Ln Spicewood TX 78669
Phone: 512-371-6159 | Fax: 512-351-8858
For terms and conditions of sales, please visit:
www.abracon.com

REVISED: 02-19-24

ABRACON IS
ISO9001-2015
CERTIFIED



Multi-layer Chip Triplexer

ATRD-R-0003

Request Samples



Check Inventory



2.0 x 1.25 x 0.90 mm
RoHS Compliant

Return Loss (1560-1606, 2400-2500, 4900- 5950MHz)

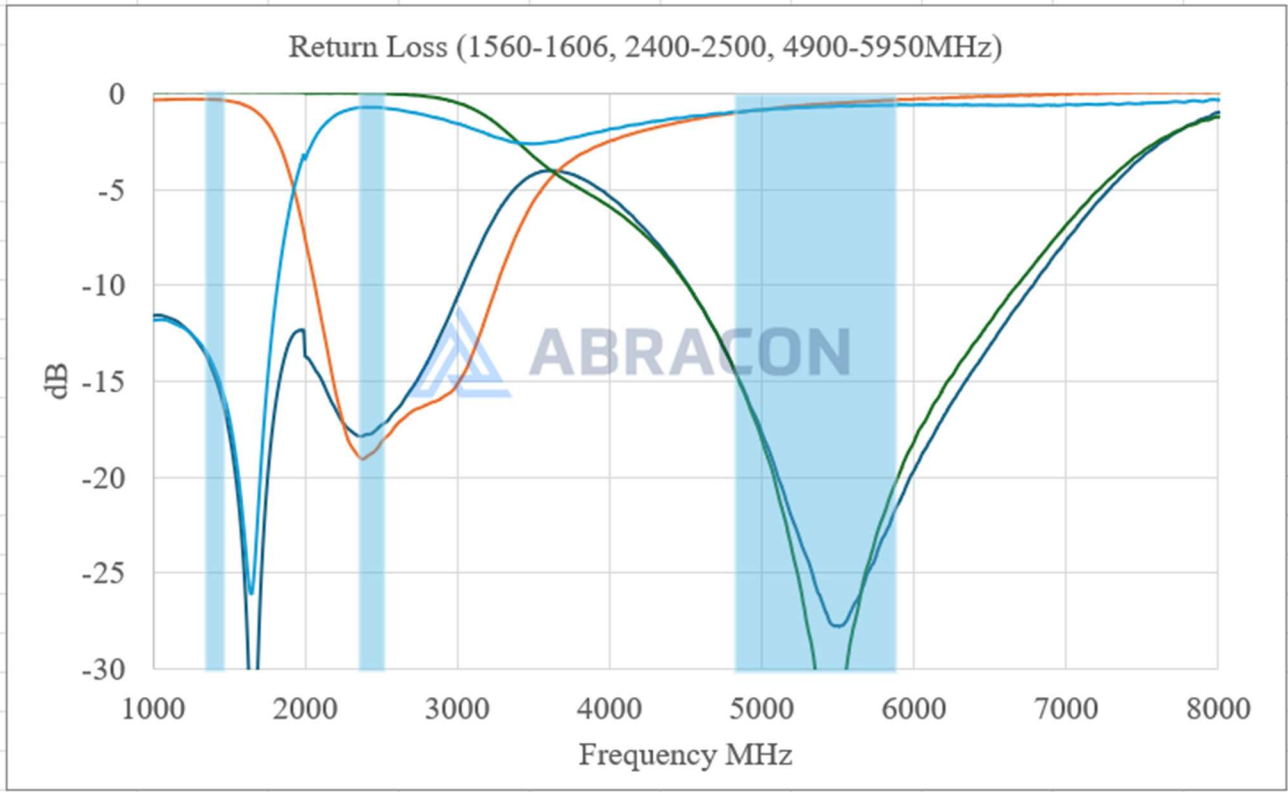

5101 Hidden Creek Ln Spicewood TX 78669
Phone: 512-371-6159 | Fax: 512-351-8858
For terms and conditions of sales, please visit:
www.abracon.com

REVISED: 02-19-24

ABRACON IS
ISO9001-2015
CERTIFIED



Multi-layer Chip Triplexer

ATRD-R-0003

Request Samples



Check Inventory



2.0 x 1.25 x 0.90 mm
RoHS Compliant

Isolation (dB) 1560-1606, 2400-2500, 4900- 5950MHz

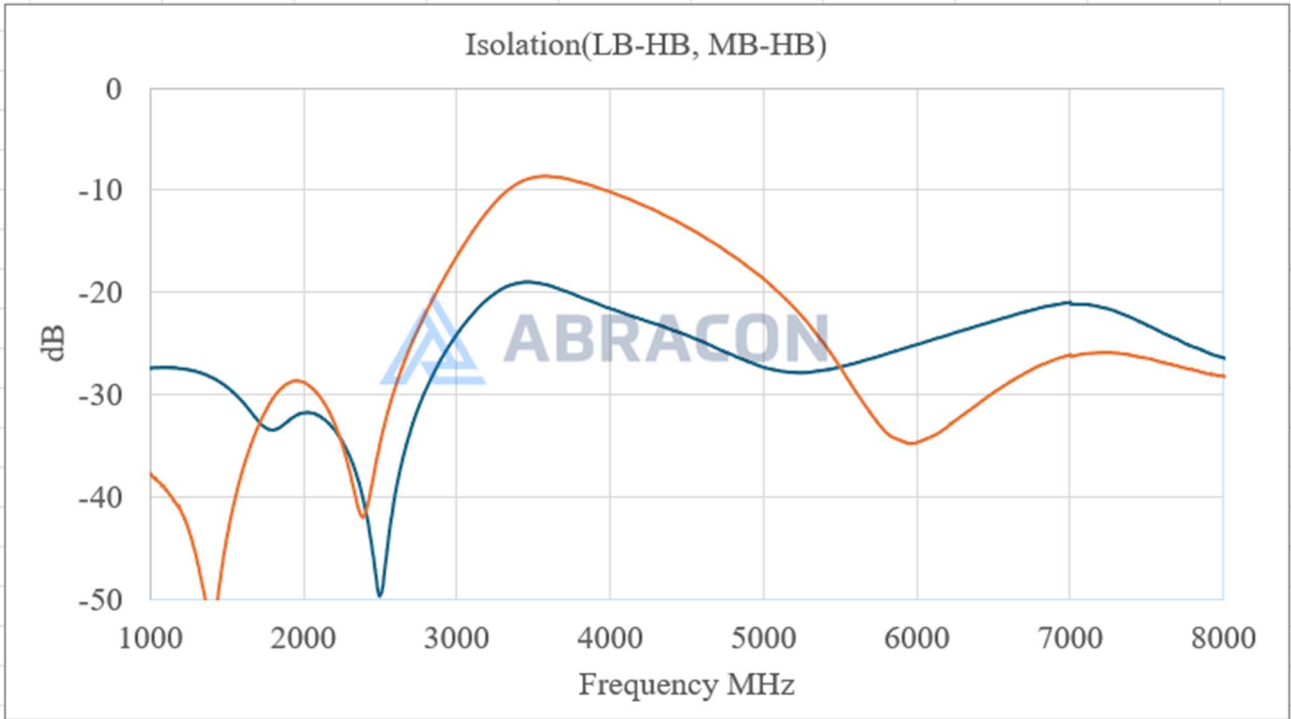

5101 Hidden Creek Ln Spicewood TX 78669
Phone: 512-371-6159 | Fax: 512-351-8858
For terms and conditions of sales, please visit:
www.abracon.com

REVISED: 02-19-24

ABRACON IS
ISO9001-2015
CERTIFIED



Multi-layer Chip Triplexer

ATRD-R-0003

Request Samples

Check Inventory

2.0 x 1.25 x 0.90 mm
RoHS Compliant

Reflow Profile

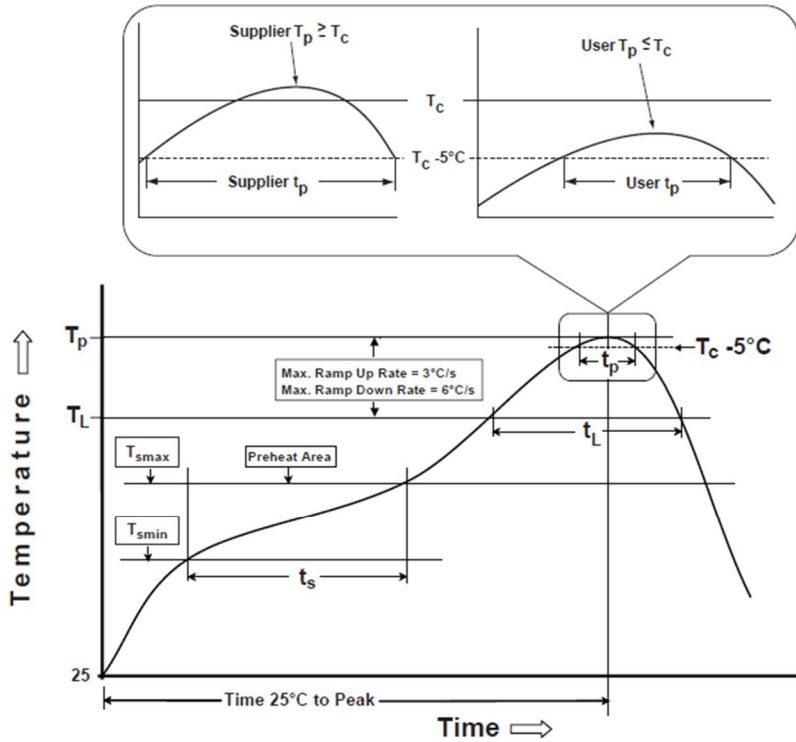

Table 1

SnPb Eutectic Process Classification Temperatures (T_c)		
Package Thickness	Volume mm^3 <350	Volume mm^3 ≥ 350
<2.5 mm	235 °C	220 °C
≥ 2.5 mm	220 °C	220 °C

Table 2

Pb-Free Process Classification Temperatures (T_c)			
Package Thickness	Volume mm^3 <350	Volume mm^3 350-2000	Volume mm^3 >2000
<1.6 mm	260 °C	260 °C	260 °C
1.6 mm - 2.5 mm	260 °C	250 °C	245 °C
>2.5 mm	250 °C	245 °C	245 °C

Profile Feature	Sn-Pb Eutectic Assembly	Pb-Free Assembly
Preheat / soak		
Temperature minimum (T_{smin})	100°C	150°C
Temperature maximum (T_{smax})	150°C	200°C
Time (T_{smin} to T_{smax}) (t_s)	60 - 120 sec.	60 - 120 sec.
Average ramp-up rate (T_{smax} to T_p)	3°C/sec. max	3°C/sec. max
Liquidous temperature (T_L)	183°C	217°C
Time at liquidous (t_L)	60 - 150 sec.	60 - 150 sec.
Peak package body temperature (T_p)*	see Table 1	see Table 2
Time (t_p)** within 5°C of the specified classification temperature (T_c)	20 sec.	30 sec.
Ramp-down rate (T_p to T_{smax})	6°C/sec. max	6°C/sec. max
Time 25°C to peak temperature	6 min. max	8 min. max
Reflow cycles	2 max	2 max

*Tolerance for peak profile temperature (T_p) is defined as a supplier minimum and a user maximum.

**Tolerance for time at peak profile temperature (t_p) is defined as supplier minimum and a user maximum.

Multi-layer Chip Triplexer



ATRD-R-0003

Request Samples



Check Inventory



2.0 x 1.25 x 0.90 mm
RoHS Compliant

Packaging

Tape Carrier Packaging:

Tape carrier packaging quantity please see the following table:

Type	2012[0805]
Tape	Embossed Tape
Quantity	4K

Taping Drawings (Unit: mm)

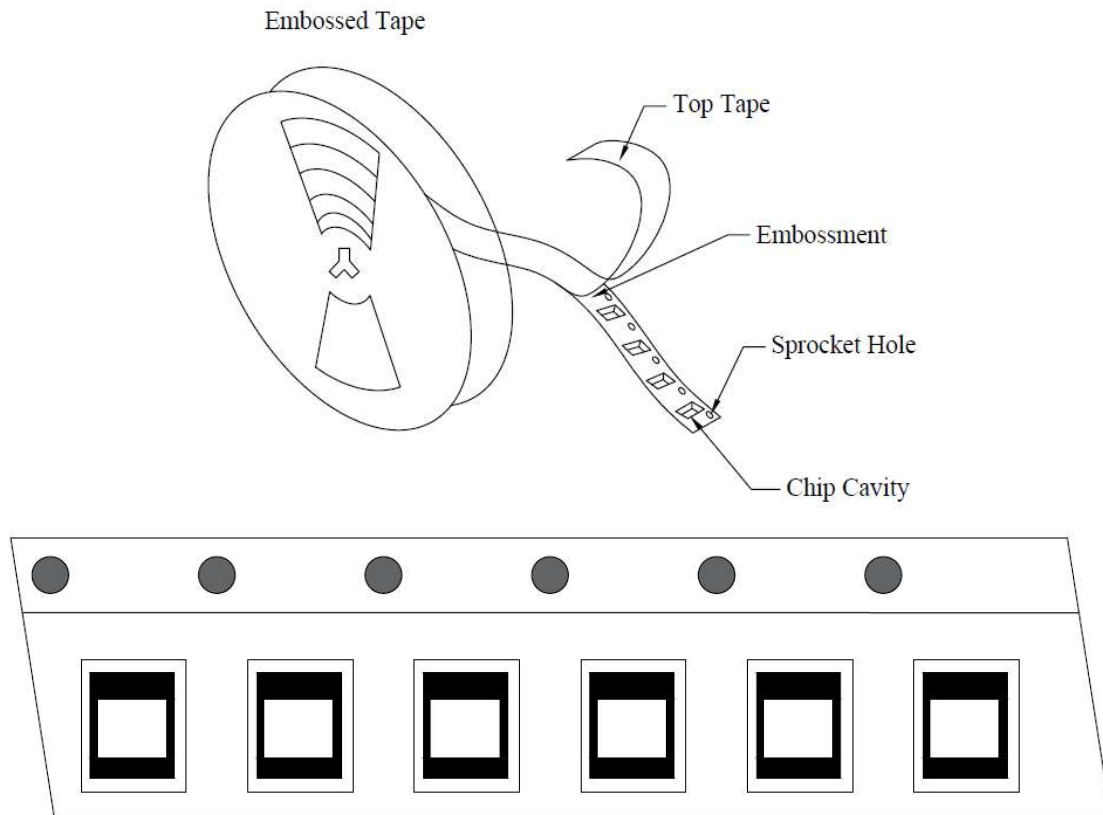

Remark: The sprocket holes are to the right as the tape is pulled toward the user.



Multi-layer Chip Triplexer

ATRD-R-0003

Request Samples



Check Inventory



2.0 x 1.25 x 0.90 mm
RoHS Compliant

Taping Dimensions (Unit: mm)

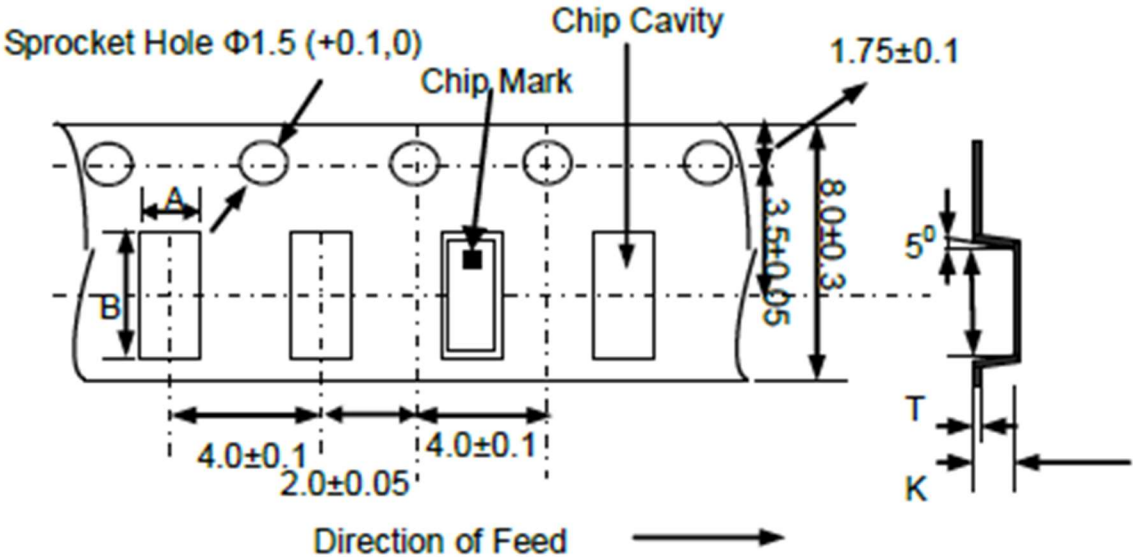

Chip Thickness	A	B	K max	T max
0.90±0.10	1.42±0.15	2.25±0.15	1.25	0.27



Multi-layer Chip Triplexer

ATRD-R-0003

Request Samples



Check Inventory



2.0 x 1.25 x 0.90 mm
RoHS Compliant

Reel Dimensions (Unit: mm)

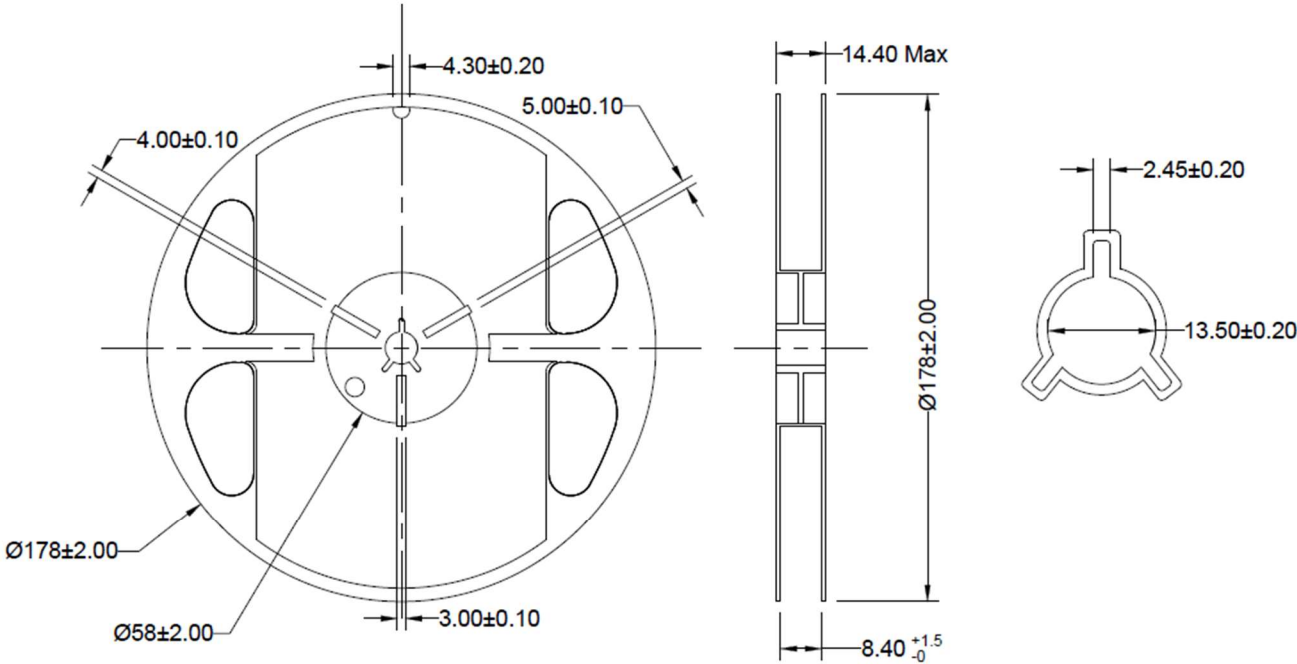

Unit: mm

ATTENTION: Abracon LLC's products are COTS – Commercial-Off-The-Shelf products; suitable for Commercial, Industrial and, where designated, Automotive Applications. Abracon's products are not specifically designed for Military, Aviation, Aerospace, Life-dependent Medical applications or any application requiring high reliability where component failure could result in loss of life and/or property. For applications requiring high reliability and/or presenting an extreme operating environment, written consent and authorization from Abracon LLC is required. Please contact Abracon LLC for more information.



5101 Hidden Creek Ln Spicewood TX 78669
Phone: 512-371-6159 | Fax: 512-351-8858
For terms and conditions of sales, please visit:
www.abracon.com

REVISED: 02-19-24

ABRACON IS
ISO9001-2015
CERTIFIED