

# OLED DISPLAY MODULE

## Application Notes

<b>PRODUCT NUMBER</b>	<b>DD-6448BE-1B with EVK board</b>
-----------------------	------------------------------------

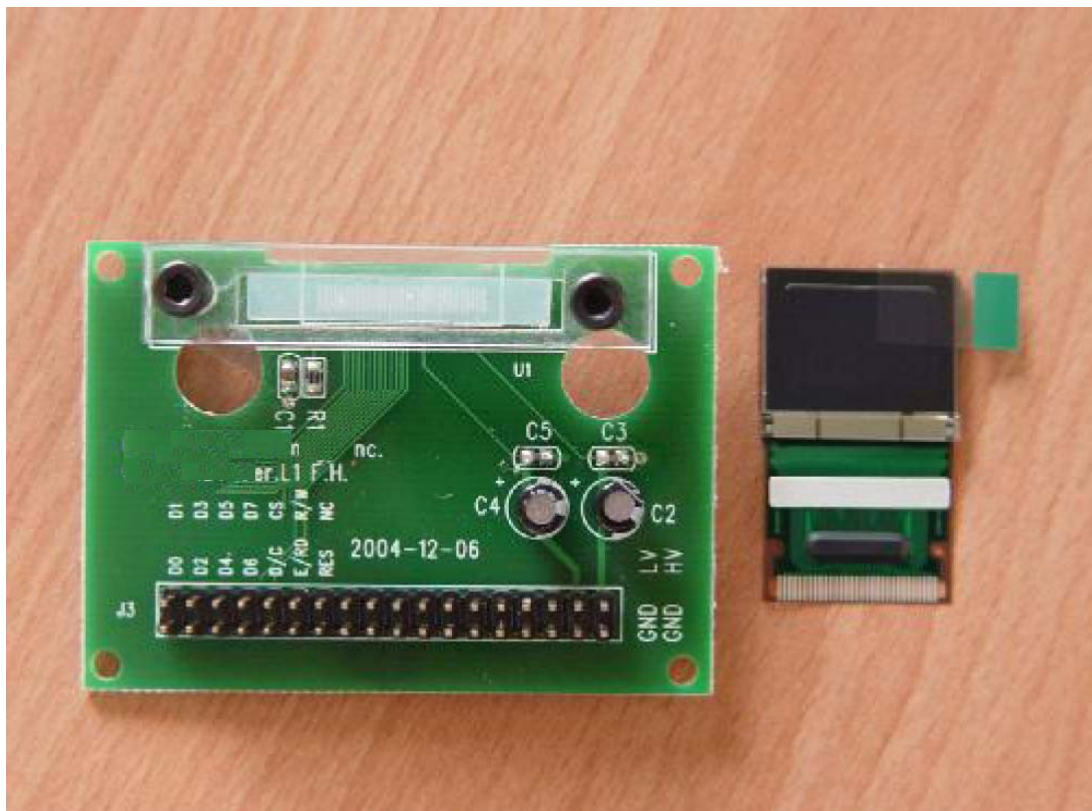

## TABLE OF CONTENTS

<b>1</b>	<b>EVK SCHEMATIC.....</b>	<b>4</b>
<b>2</b>	<b>SYMBOL DEFINITION .....</b>	<b>5</b>
<b>3</b>	<b>TIMING CHARACTERISTICS .....</b>	<b>6</b>
<b>4</b>	<b>CONNECTION BETWEEN OLED AND EVK .....</b>	<b>7</b>
<b>5</b>	<b>HOW TO USE THE DD-6448BE-1B .....</b>	<b>9</b>
5.1	RECOMMENDED INITIAL CODE .....	10

Product No.	DD-6448BE-1B	REV. A

Page	2 / 11
------	--------

REVISION RECORD

Rev.	Date	Page	Chapt.	Comment	ECR no.
A	10 Jan 07			First Issue	

Product No.	DD-6448BE-1B	REV. A

Page	3 / 11
------	--------

# 1 EVK Schematic

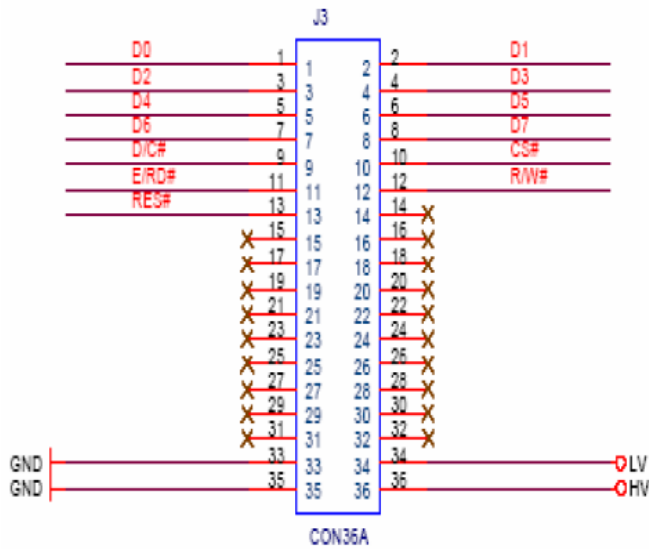
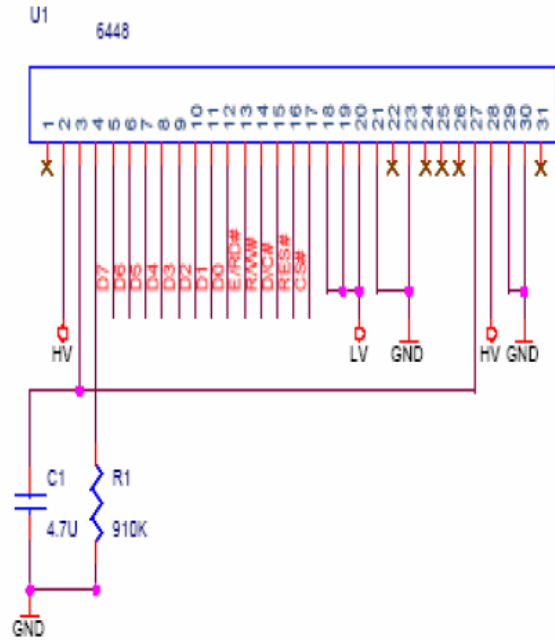
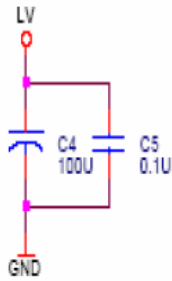
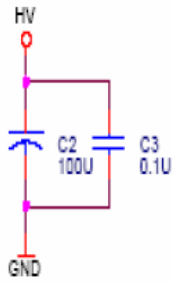

Product No.	DD-6448BE-1B	REV. A

Page	4 / 11
------	--------

## 2 Symbol Definition

**Note:** The EVK has been hard wired to 8080 parallel interface

**D0-D7 :** These pins are 8-bit bi-directional data bus to be connected to the MCU's data bus.

**E/RD# :** This pin is MCU interface input. When connecting to an 8080-microprocessor, this pin receives the Read (RD) signal. Data read operation is initiated when this pin is pulled low and the chip is selected.

**R/W# :** This pin is MCU interface input. When 8080 interface mode is selected, this pin is the Write (WR) input. Data write operation is initiated when this pin is pulled low and the chip is selected.

**D/C# :** This pin is Data/Command control pin. When the pin is pulled high, the data at D0-D7 is treated as display data. When the pin is pulled low, the data at D0-D7 is transferred to the command register. For detail relationship to MCU interface signals, please refer to the timing characteristics diagrams at following pages and datasheet.

**RES# :** This pin is reset signal input. When the pin is low, initialization of the chip is executed.

**CS# :** This pin is the chip select input. The chip is enabled for MCU communication only when CS is pulled low.

**HV:** This is the most positive voltage supply pin of the chip.

**LV :** Power supply pin for logic operation of the driver.

**VCC :** This is the most positive voltage supply pin of the chip.

**VSS :** This is the ground pin and also acts as a reference for logic pins and OLED driving voltages. This should be connected to the external ground

**VCOMH :** This is an input pin for the voltage output high level for COM signals. A capacitor should be connected between this pin and VSS.

**NC :** Dummy pad, do not group or short NC pins together.

Product No.	DD-6448BE-1B	REV. A

Page	5 / 11
------	--------

### 3 Timing characteristics

VDD = 2.4 to 3.5V, TA= -40to 85°C

Symbol	Parameter	Min	Typ	Max	Unit
$t_{cycle}$	Clock Cycle Time	300	-	-	ns
$t_{AS}$	Address Setup Time	0	-	-	ns
$t_{AH}$	Address Hold Time	0	-	-	ns
$t_{DSW}$	Write Data Setup Time	40	-	-	ns
$t_{DHW}$	Write Data Hold Time	15	-	-	ns
$t_{DHR}$	Read Data Hold Time	20	-	-	ns
$t_{OH}$	Output Disable Time	-	-	70	ns
$t_{ACC}$	Access Time	-	-	140	ns
$PW_{CSL}$	Chip Select Low Pulse Width (read)	120	-	-	ns
	Chip Select Low Pulse Width (write)	60	-	-	ns
$PW_{CSH}$	Chip Select High Pulse Width (read)	60	-	-	ns
	Chip Select High Pulse Width (write)	60	-	-	ns
$t_R$	Rise Time	-	-	15	ns
$t_F$	Fall Time	-	-	15	ns

**Table 3 8080-Series MPU Parallel Interface Timing Characteristics**

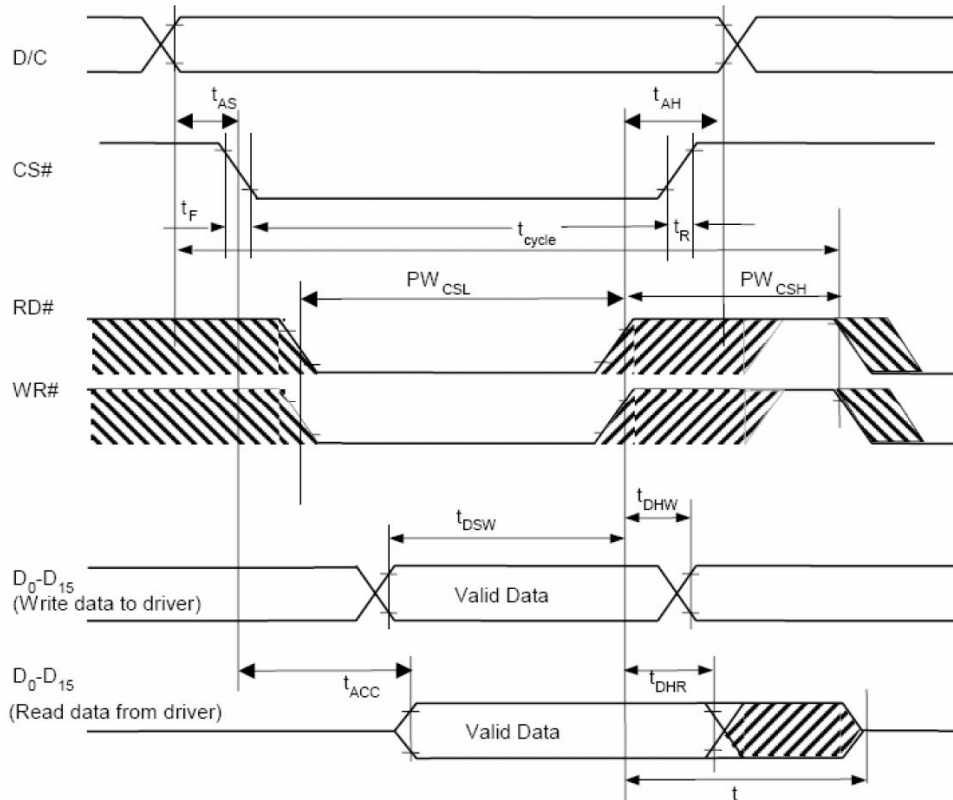

**Figure 1 8080-series MPU parallel interface characteristics**

Product No.	DD-6448BE-1B	REV. A

Page	6 / 11
------	--------



As the package is TCP, the connector pads are double sided. When assembling the OLED, make sure it in the right direction as shown in Figure 3 and tightened with the two hexagonal bolts.

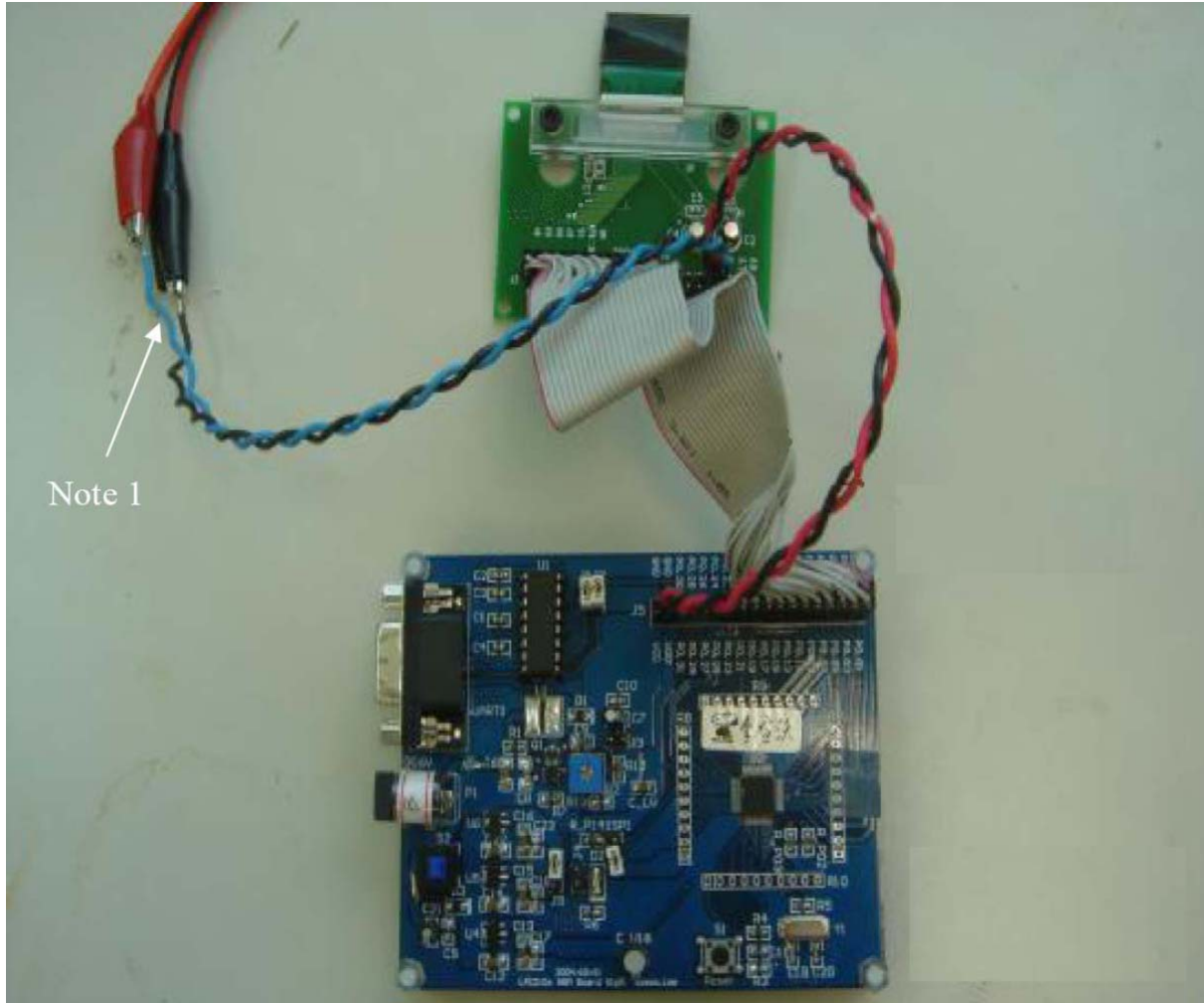

**Figure 4 control MCU (not supplied) connected with EVK**

Note 1 : It is the external most positive voltage supply. In this sample is connected to power supply.

Product No.	DD-6448BE-1B	REV. A

Page	8 / 11
------	--------



## 5 How to use the DD-6448BE-1B

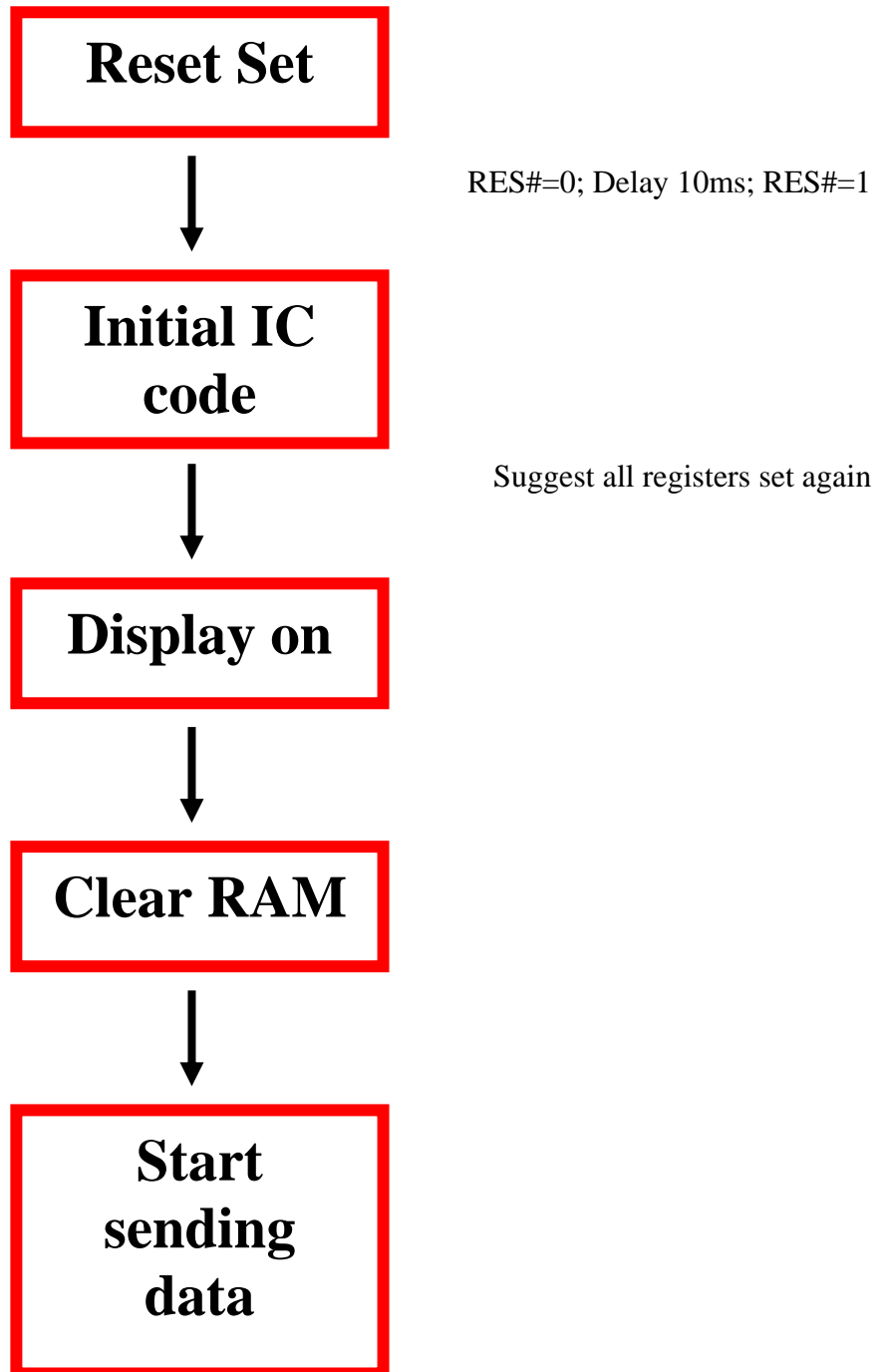

Product No.	DD-6448BE-1B	REV. A

Page	9 / 11
------	--------

## 5.1 Recommended Initial code

---

```

void initial(void)
{
BS1=1;           // use 8080 interface
BS2=1;
DC=0;
WR=0;
RD=0;
CS=0;
RES=0;
delay(100);
RES=1;
write_c(0xAE);   //display off
write_c(0x81);   //set contrast
write_c(0xff);   //max current
write_c(0xa8);   //set duty
write_c(0x3F);   //duty 63
write_c(0xA0);   //Set Segment Re-map
write_c(0xd3);   //display offset
write_c(0x00);   //set 00
write_c(0x40);   //Start line
write_c(0xC8);   //Set COM Output Scan Direction
write_c(0xda);   //Set COM pins hardware configuration
write_c(0x12);   //Set COM pins hardware configuration
write_c(0xD9);   //Set precharge
write_c(0xf1);   //precharge=fh , discharge=1h
write_c(0xDB);   //Set VcomH
write_c(0x49);   //VcomH=73
write_c(0xA4);   //Normal Mode
write_c(0xA6);   //No Inverse
write_c(0xAF);   //display on
}
void write_c(unsigned char ins_c)
{
DC=0;
CS=0;
RD=1;           /*tell system only write*/
WR=0;
d_bus=ins_c;
WR=1;
CS=1;
DC=1;
}

```

Product No.	DD-6448BE-1B	REV. A

Page	10 / 11
------	---------

```

void write_d(unsigned char ins_d)
{
DC=1;
CS=0;
RD=1;           /*tell system only write*/
WR=0;
d_bus=ins_d;
CS=1;
WR=1;
DC=1;
}
void delay(int count)
{
int i,j;
for(i=0;i<=count;i++)
for(j=0;j<=1000;j++)
;
}
* write_c= Write Command , write_d= Write Data

```

Product No.	DD-6448BE-1B	REV. A

Page	11 / 11
------	---------