



# DL50-P1123

Dx50

MID RANGE DISTANCE SENSORS

**SICK**  
Sensor Intelligence.



### Ordering information

Type	Part no.
DL50-P1123	1047361

Other models and accessories → [www.sick.com/Dx50](http://www.sick.com/Dx50)



### Detailed technical data

#### Mechanics/electronics

<b>Supply voltage <math>V_s</math></b>	DC 10 V ... 30 V <sup>1)</sup>
<b>Ripple</b>	$\leq 5 V_{pp}$ <sup>2)</sup>
<b>Power consumption</b>	$\leq 2.1 W$ <sup>3)</sup>
<b>Initialization time</b>	$\leq 250$ ms
<b>Warm-up time</b>	$\leq 15$ min
<b>Housing material</b>	Metal (zinc diecast)
<b>Window material</b>	Plastic (PMMA)
<b>Connection type</b>	Male connector, M12, 5-pin
<b>Indication</b>	LC display, 2 x LED
<b>Weight</b>	200 g
<b>Dimensions (W x H x D)</b>	36.1 mm x 62.7 mm x 57.7 mm
<b>Enclosure rating</b>	IP65
<b>Protection class</b>	III

<sup>1)</sup> Limit values, reverse-polarity protected, operation in short-circuit protected network: max. 8 A.

<sup>2)</sup> May not fall short of or exceed  $V_S$  tolerances.

<sup>3)</sup> Without load.

#### Safety-related parameters

<b>MTTF<sub>D</sub></b>	101 years
-------------------------	-----------

#### Performance

<b>Measurement range min ... max:</b>	200 mm ... 50,000 mm, on "diamond grade" reflective tape <sup>1)</sup>
---------------------------------------	--

<sup>1)</sup> On "diamond grade" reflective tape.

<sup>2)</sup> Equivalent to  $1 \sigma$ .

<sup>3)</sup> Dependent on the averaging setting: fast/slow.

<sup>4)</sup> Lateral entry of the object into the measuring range.

<sup>5)</sup> Continuous change of distance in measuring range.

<sup>6)</sup> Wavelength: 658 nm; max. output: 120 mW; pulse duration: 2.5 ns; duty cycle: 1/400.

<b>Target</b>	Reflector
<b>Resolution</b>	1 mm
<b>Repeatability</b>	≥ 2 mm <sup>2) 3)</sup>
<b>Accuracy</b>	± 7 mm
<b>Response time</b>	15 ms ... 30 ms, 15 ms / 30 ms <sup>3) 4)</sup>
<b>Output time</b>	≥ 4 ms <sup>5)</sup>
<b>Light source</b>	Laser, red visible red light
<b>Laser class</b>	1 (IEC 60825-1:2014, EN 60825-1:2014) <sup>6)</sup>
<b>Typ. light spot size (distance)</b>	15 mm x 15 mm (10 m)
<b>Additional function</b>	Set moving average: fast/slow, switching mode: distance to object (DtO), teach-in, scaling and inversion of digital output, set hysteresis, teach-in, scaling and inversion of analog output, Multifunctional input: laser off / external teach / deactivated, switch-off display, reset to factory default, lock user interface
<b>Average laser service life (at 25 °C)</b>	100,000 h

- 1) On "diamond grade" reflective tape.
- 2) Equivalent to 1  $\sigma$ .
- 3) Dependent on the averaging setting: fast/slow.
- 4) Lateral entry of the object into the measuring range.
- 5) Continuous change of distance in measuring range.
- 6) Wavelength: 658 nm; max. output: 120 mW; pulse duration: 2.5 ns; duty cycle: 1/400.

## Interfaces

<b>Digital output</b>	Number	1 <sup>1) 2)</sup>
	Type	PNP
	Maximum output current $I_A$	≤ 100 mA
<b>Analog output</b>	Number	1
	Type	Current output
	Current	4 mA ... 20 mA, ≤ 300 $\Omega$
	Resolution	16 bit
<b>Multifunctional input (MF)</b>		1 x <sup>3) 4)</sup>
<b>Hysteresis</b>		10 mm ... 1,000 mm

- 1) Output Q short-circuit protected.
- 2) PNP: HIGH =  $V_S - (< 2.5 V)$  / LOW = 0 V.
- 3) Response time ≤ 15ms.
- 4) PNP: HIGH =  $V_S$  / LOW = ≤ 2.5 V.

## Ambient data

<b>Ambient temperature, operation</b>	-30 °C ... +65 °C -30 °C ... +80 °C, operation with 2 cooling plates -30 °C ... +140 °C, operation with 2 cooling plates and protection filter
<b>Ambient temperature, storage</b>	-40 °C ... +75 °C
<b>Max. rel. humidity (not condensing)</b>	≤ 95 %
<b>Typ. Ambient light immunity</b>	40,000 lx
<b>Vibration resistance</b>	EN 60068-2-6, EN 60068-2-64

<b>Shock resistance</b>	EN 60068-2-27
-------------------------	---------------

## Classifications

<b>eCl@ss 5.0</b>	27270801
<b>eCl@ss 5.1.4</b>	27270801
<b>eCl@ss 6.0</b>	27270801
<b>eCl@ss 6.2</b>	27270801
<b>eCl@ss 7.0</b>	27270801
<b>eCl@ss 8.0</b>	27270801
<b>eCl@ss 8.1</b>	27270801
<b>eCl@ss 9.0</b>	27270801
<b>eCl@ss 10.0</b>	27270801
<b>eCl@ss 11.0</b>	27270801
<b>eCl@ss 12.0</b>	27270916
<b>ETIM 5.0</b>	EC001825
<b>ETIM 6.0</b>	EC001825
<b>ETIM 7.0</b>	EC001825
<b>ETIM 8.0</b>	EC001825
<b>UNSPSC 16.0901</b>	41111613

**Dimensional drawing** (Dimensions in mm (inch))

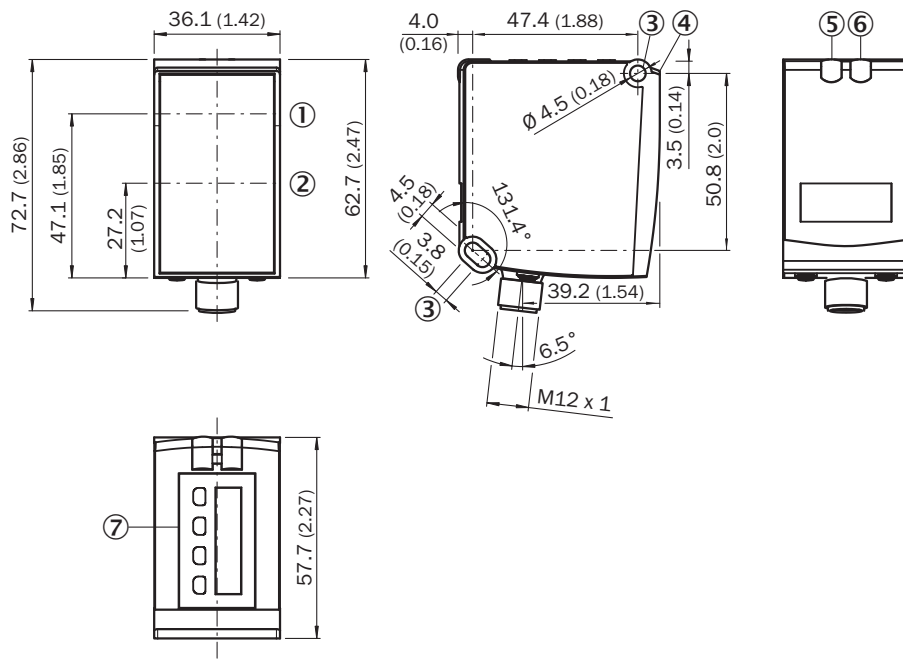

- ① Optical axis, sender
- ② Optical axis, receiver
- ③ Fixing hole
- ④ Reference surface = 0 mm
- ⑤ Status indicator digital output Q<sub>1</sub> (orange)
- ⑥ DT50/DT50 Hi/DL50: Status display for supply voltage active (green), DS50/DL50 Hi: Status display of digital output Q<sub>2</sub> (orange)
- ⑦ Control elements and display

**Connection type**

Male connector M12, 5-pin

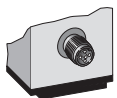



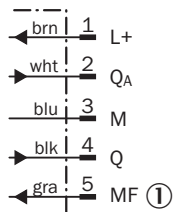

**Connection diagram**



- ① Multifunctional input (MF)

## Recommended accessories

Other models and accessories → [www.sick.com/Dx50](http://www.sick.com/Dx50)

	Brief description	Type	Part no.
Plug connectors and cables			
	Head A: female connector, M12, 5-pin, straight, A-coded Head B: Flying leads Cable: Sensor/actuator cable, PVC, unshielded, 2 m	YF2A15-020VB5XLEAX	2096239
	Head A: female connector, M12, 5-pin, angled, A-coded Head B: Flying leads Cable: Sensor/actuator cable, PVC, unshielded, 2 m	YG2A15-020VB5XLEAX	2096215
Reflectors			
	Reflector plate, "diamond grade" reflective tape, 330 mm x 330 mm, base plate material: aluminum, screw connection, Screw-on, 4 hole mounting	PL240DG	1017910
Terminal and alignment brackets			
	Alignment unit, steel, zinc coated, mounting hardware for the sensor included	BEF-AH-DX50	2048397

## Recommended services

Additional services → [www.sick.com/Dx50](http://www.sick.com/Dx50)

	Type	Part no.
Extended warranty		
<ul style="list-style-type: none"> <li>• <b>Product area:</b> Identification solutions, machine vision, Distance sensors, Detection and ranging solutions</li> <li>• <b>Range of services:</b> The services correspond to the scope of the statutory manufacturer warranty (SICK general terms of delivery).</li> <li>• <b>Duration:</b> Five-year warranty from delivery date.</li> </ul>	Extended warranty for a total of five years from delivery date	1680671

## SICK AT A GLANCE

SICK is one of the leading manufacturers of intelligent sensors and sensor solutions for industrial applications. A unique range of products and services creates the perfect basis for controlling processes securely and efficiently, protecting individuals from accidents and preventing damage to the environment.

We have extensive experience in a wide range of industries and understand their processes and requirements. With intelligent sensors, we can deliver exactly what our customers need. In application centers in Europe, Asia and North America, system solutions are tested and optimized in accordance with customer specifications. All this makes us a reliable supplier and development partner.

Comprehensive services complete our offering: SICK LifeTime Services provide support throughout the machine life cycle and ensure safety and productivity.

For us, that is “Sensor Intelligence.”

## WORLDWIDE PRESENCE:

Contacts and other locations –[www.sick.com](http://www.sick.com)