



DS50-P1122

Dx50

MID RANGE DISTANCE SENSORS

SICK
Sensor Intelligence.



Ordering information

Type	Part no.
DS50-P1122	1047405

Other models and accessories → www.sick.com/Dx50



Detailed technical data

Mechanics/electronics

Supply voltage V_s	DC 10 V ... 30 V ¹⁾
Ripple	$\leq 5 V_{pp}$ ²⁾
Power consumption	$\leq 1.85 W$ ³⁾
Initialization time	≤ 350 ms
Warm-up time	≤ 15 min
Housing material	Metal (zinc diecast)
Window material	Plastic (PMMA)
Connection type	Male connector, M12, 5-pin
Indication	LC display, 2 x LED
Weight	200 g
Dimensions (W x H x D)	36.1 mm x 62.7 mm x 57.7 mm
Enclosure rating	IP65
Protection class	III

¹⁾ Limit values, reverse-polarity protected, operation in short-circuit protected network: max. 8 A.

²⁾ May not fall short of or exceed V_s tolerances.

³⁾ Without load.

Safety-related parameters

MTTF_D	101 years
-------------------------	-----------

Performance

Measurement range min ... max:	200 mm ... 10,000 mm, 90% remission factor 200 mm ... 6,000 mm, 18 % remission
---------------------------------------	---

¹⁾ Related to distance value on the display.

²⁾ Equivalent to 1σ .

³⁾ 6% ... 90% remission factor.

⁴⁾ Dependent on the averaging setting: fast/slow.

⁵⁾ 90% remission factor.

⁶⁾ Wavelength: 658 nm; max. output: 120 mW; pulse duration: 2.5 ns; duty cycle: 1/400.

	200 mm ... 4,000 mm, 6% remission factor
Target	Natural objects
Resolution	1 mm ¹⁾
Repeatability	≥ 2.5 mm ^{2) 3) 4)}
Accuracy	± 10 mm ^{1) 5)}
Response time	20 ms ... 100 ms, 20 ms / 100 ms ⁴⁾
Switching frequency	25 Hz / 5 Hz ⁴⁾
Light source	Laser, red visible red light
Laser class	1 (IEC 60825-1:2014, EN 60825-1:2014) ⁶⁾
Typ. light spot size (distance)	15 mm x 15 mm (10 m)
Additional function	Set moving average: fast/slow, adjustable operating modes: Switching point (DtO) / Switching window/Background (ObSB), teach-in, scaling and inversion of digital output, set hysteresis, Multifunctional input: laser off / external teach / deactivated, Unique measurement value, crosstalk safety, switch-off display, reset to factory default, lock user interface
Average laser service life (at 25 °C)	100,000 h

¹⁾ Related to distance value on the display.

²⁾ Equivalent to 1 σ .

³⁾ 6% ... 90% remission factor.

⁴⁾ Dependent on the averaging setting: fast/slow.

⁵⁾ 90% remission factor.

⁶⁾ Wavelength: 658 nm; max. output: 120 mW; pulse duration: 2.5 ns; duty cycle: 1/400.

Interfaces

Digital output	Number	2 ^{1) 2)}
	Type	PNP
	Maximum output current I_A	≤ 100 mA
Multifunctional input (MF)		1 x ^{3) 4)}
Hysteresis		1 mm ... 9,999 mm

¹⁾ Output Q short-circuit protected.

²⁾ PNP: HIGH = $V_S - (< 2.5 V)$ / LOW = 0 V.

³⁾ Response time ≤ 60 ms.

⁴⁾ PNP: HIGH = V_S / LOW = ≤ 2.5 V.

Ambient data

Ambient temperature, operation	-30 °C ... +65 °C -30 °C ... +80 °C, operation with 2 cooling plates -30 °C ... +140 °C, operation with 2 cooling plates and protection filter
Ambient temperature, storage	-40 °C ... +75 °C
Max. rel. humidity (not condensing)	≤ 95 %
Typ. Ambient light immunity	40,000 lx
Vibration resistance	EN 60068-2-6, EN 60068-2-64
Shock resistance	EN 60068-2-27

Classifications

eCl@ss 5.0	27270801
-------------------	----------

eCl@ss 5.1.4	27270801
eCl@ss 6.0	27270801
eCl@ss 6.2	27270801
eCl@ss 7.0	27270801
eCl@ss 8.0	27270801
eCl@ss 8.1	27270801
eCl@ss 9.0	27270801
eCl@ss 10.0	27270801
eCl@ss 11.0	27270801
eCl@ss 12.0	27270916
ETIM 5.0	EC001825
ETIM 6.0	EC001825
ETIM 7.0	EC001825
ETIM 8.0	EC001825
UNSPSC 16.0901	41111613

Dimensional drawing (Dimensions in mm (inch))

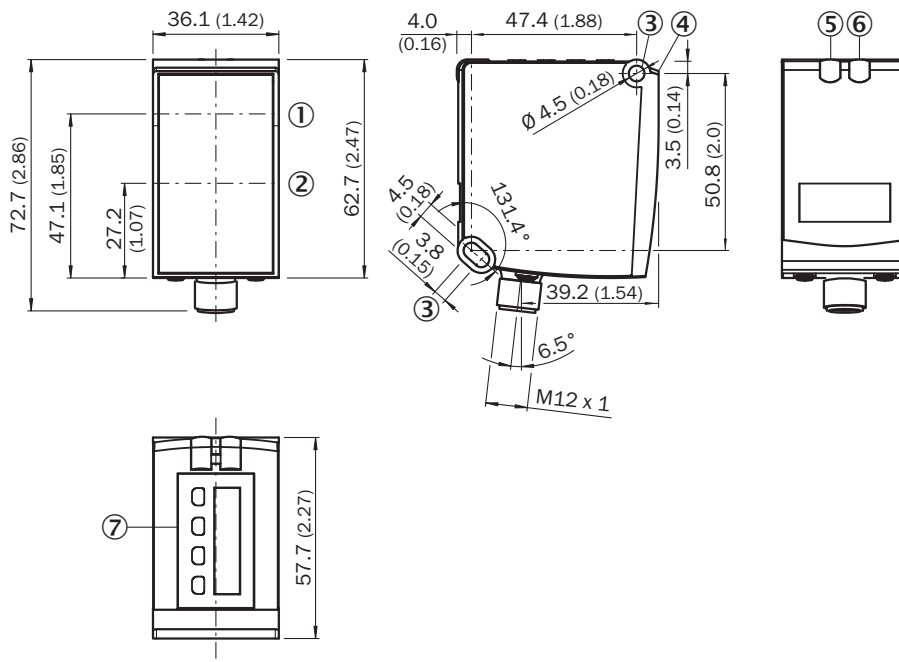

- ① Optical axis, sender
- ② Optical axis, receiver
- ③ Fixing hole
- ④ Reference surface = 0 mm
- ⑤ Status indicator digital output Q₁ (orange)
- ⑥ DT50/DT50 Hi/DL50: Status display for supply voltage active (green), DS50/DL50 Hi: Status display of digital output Q₂ (orange)
- ⑦ Control elements and display

Connection type

Male connector M12, 5-pin

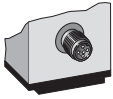



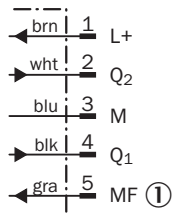

Connection diagram



① Multifunctional input (MF)

Recommended accessories

Other models and accessories → www.sick.com/Dx50

	Brief description	Type	Part no.
Mounting brackets and plates			
	Mounting bracket, steel, zinc coated, steel, zinc coated, mounting hardware for the sensor included	BEF-WN-DX50	2048370
Plug connectors and cables			
	Head A: female connector, M12, 5-pin, straight, A-coded Head B: Flying leads Cable: Sensor/actuator cable, PUR, halogen-free, unshielded, 2 m	YF2A15-020UB5XLEAX	2095617
	Head A: female connector, M12, 5-pin, straight, A-coded Head B: Flying leads Cable: Sensor/actuator cable, PVC, unshielded, 2 m	YF2A15-020VB5XLEAX	2096239
	Head A: female connector, M12, 5-pin, angled, A-coded Head B: Flying leads Cable: Sensor/actuator cable, PVC, unshielded, 2 m	YG2A15-020VB5XLEAX	2096215

Recommended services

Additional services → www.sick.com/Dx50

	Type	Part no.
Extended warranty		
<ul style="list-style-type: none">• Product area: Identification solutions, machine vision, Distance sensors, Detection and ranging solutions• Range of services: The services correspond to the scope of the statutory manufacturer warranty (SICK general terms of delivery).• Duration: Five-year warranty from delivery date.	Extended warranty for a total of five years from delivery date	1680671

SICK AT A GLANCE

SICK is one of the leading manufacturers of intelligent sensors and sensor solutions for industrial applications. A unique range of products and services creates the perfect basis for controlling processes securely and efficiently, protecting individuals from accidents and preventing damage to the environment.

We have extensive experience in a wide range of industries and understand their processes and requirements. With intelligent sensors, we can deliver exactly what our customers need. In application centers in Europe, Asia and North America, system solutions are tested and optimized in accordance with customer specifications. All this makes us a reliable supplier and development partner.

Comprehensive services complete our offering: SICK LifeTime Services provide support throughout the machine life cycle and ensure safety and productivity.

For us, that is “Sensor Intelligence.”

WORLDWIDE PRESENCE:

Contacts and other locations –www.sick.com